

HVAC-R PRODUCT GUIDE



JASON INDUSTRIAL® is a member of the Megadyne Group. Megadyne Group companies manufacture, fabricate and supply Power Transmission Belting, Material Handling Hoses and Accessories for a wide range of industries.

This brochure presents Jason Industrials' portfolio of belts and accessories that serve the needs of the HVAC-R markets.

As our customer you can feel confident in the quality and integrity of our products, the speed and efficiency at which they are delivered, along with the expertise and customer focus that we are committed to providing.

Our US Headquarters is located in Fairfield, NJ. Customer Service and our Distribution Center are located just outside of Chicago, IL.

MEGADYNE, headquartered near Mathi Italy, is a global manufacturer of rubber and urethane power transmission, product handling and linear positioning drive belts.

For more information on our products and full product offerings, please visit:

www.MegadyneGroup.com
www.JasonIndustrial.com

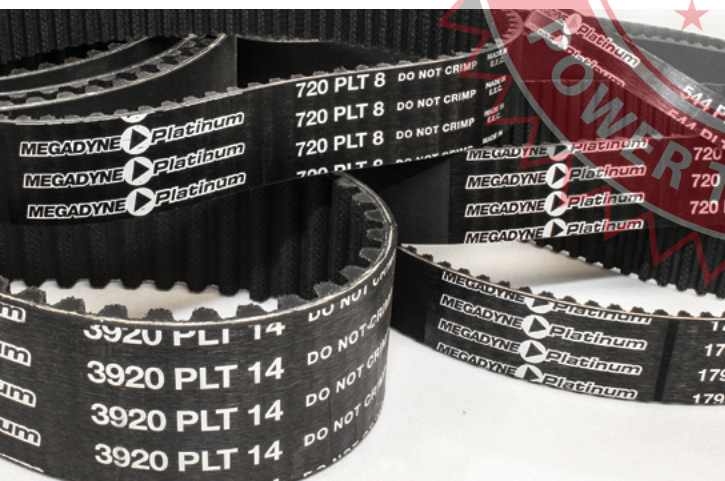
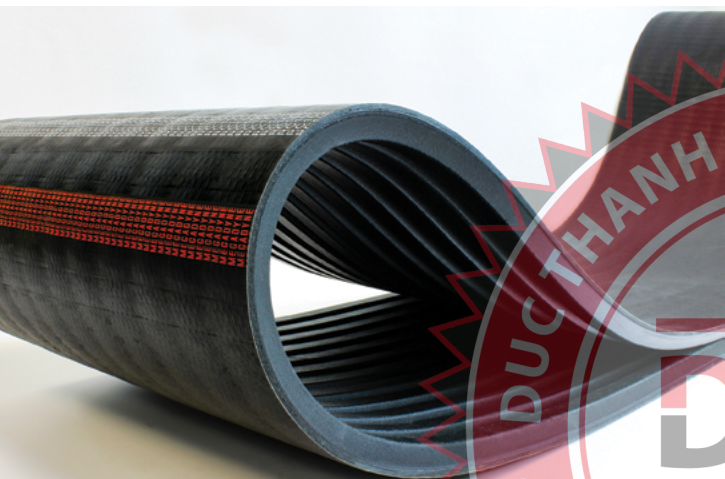

The following trademarks have been registered in the United States Patent and Trademark Office by their owners:

- Accu-Link® is a registered trademark of Jason Industrial (Megadyne Group)
- RPP® is a registered trademark of the Timken company (formerly Carlisle)
- Poly Chain®, PCGT®, HTD®, PowerGrip® and GT® are registered trademarks of the Gates Corporation
- Isoran® is a registered trademark of Dayco Europe S.R.L.

WARNING: This catalog contains products that can expose you to chemicals including carbon black, DINP, and/or lead which is known in the state of California to cause cancer, birth defects or other reproductive harm. For more information visit www.P65WARNINGS.ca.gov

INTRODUCTION

	UniMatch® V-Belts for HVAC Drives	3	
	Energy Efficient Belt Drives for Air Handling	4	
<hr/>			
V-BELTS	Fractional Horsepower (FHP)	3L	5
	UniMatch® Classical Multi-Plus®	A, B, C, D, E	6
	UniMatch® Cogged Raw Edge Classical	AX, BX, CX	11
	UniMatch® Deep Wedge	3V, 5V, 8V	13
	UniMatch® Cogged Raw Edge Deep Wedge	3VX, 5VX	15
	Accu-Link® – Detachable Tab Type Link	3L, A, B, C, CC	17
	Accu-Link® – Assembly & Disassembly		18
	Accu-Link® – Comparative Length Table - 3L		19
Accu-Link® – Comparative Length Table - A/4L, B/5L		19	
<hr/>			
BANDED V-BELTS	UniMatch® Banded Classical	RB, RC, RD	21
	UniMatch® Banded Deep Wedge	R3V, R5V, R8V	23
	UniMatch® Banded Cogged Raw Edge Deep Wedge V-Belt	R3VX, R5VX	25
<hr/>			
SYNCHRONOUS BELTS	RPC Platinum - Ultra High Torque	PLT8M, PLT14M	27
<hr/>			
PULLEYS & BUSHINGS	Pulleys & Bushings		29
	Light & Heavy Duty, Variable Pitch, AL (Blower), QD, Synchronous, Made To Order		29
<hr/>			
TECHNICAL DATA	Drive Belt Nomenclature - V-Belts		31
	Drive Belt Nomenclature - Synchronous Belts		32
	Synchronous Belt - Tooth Profile Dimensions		33
	V-Belt Failure Analysis		34
	V-Belt Pulley Inspection		35
	V-Belt Tensioning		36
	Troubleshooting V-Belt Drives		37
Troubleshooting Synchronous Drives		38	
<hr/>			
BELT ACCESSORIES	V-Belt Display		39
	V-Belt Wall Rack		39
	Sheave Gauge		39
	V-Belt Measurer		39
	Tension Tester Gauge		39
	Electronic Tension Meter - DTM-Micro		39
<hr/>			
	TERMS, CONDITIONS AND LIMITED WARRANTY OF SALE	42	

INTRODUCTION

Megadyne UniMatch® V-Belts

Your best choice for HVAC drives!

- Better Value
- Better Service
- Better Inventory
- Precision engineered to measure within ARPM matching limits.
- Multi-Plus® - Dual Branded to reduce inventories! Discontinue your 4L & 5L inventory!
- Made to Perform and Priced to compete!

Multi-Plus® A, B, C, D, E



Cogged Raw Edge AX, BX, CX

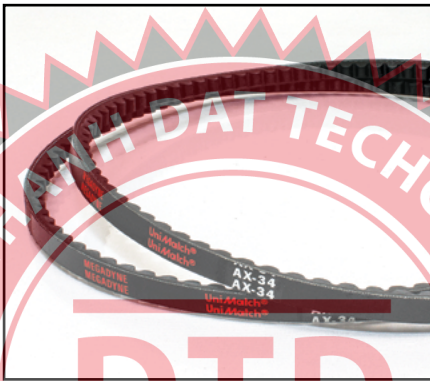

Fractional Horsepower 3L Section



Deep Wedge 3V, 5V, 8V



Cogged Raw Edge Deep Wedge 3VX, 5VX



Banded Classical RB, RC, RD

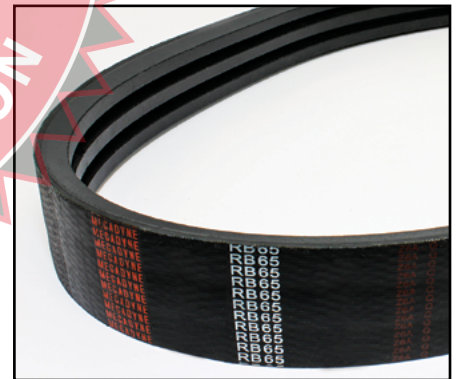

Accu-Link® 3L, A, B, C, CC

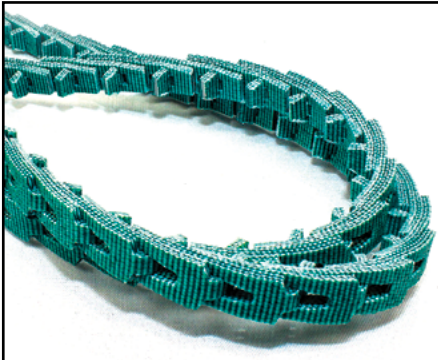

Banded Deep Wedge Cog R3VX, R5VX



Banded Deep Wedge R3V, R5V, R8V





Energy Efficient Belt Drives for Air Handling Equipment

Replacing V-belts with Synchronous Belts in Air Handling applications has been recognized by the U.S. Department of Energy as a “best practice” to reduce energy requirements in Industrial and Commercial applications.

WHY ARE MEGADYNE SYNCHRONOUS BELTS CONSIDERED GREEN?

At the time of installation V-belt drives operate at 95% - 98% efficiency, efficiency ratings drop to approximately 93% over the life of the belt and remain there when properly maintained. Most efficiency losses occur in the first 24 hours of operation, creating the need to re-tension the belt. If V-belt drives are not re-tensioned as part of a preventative maintenance program, they can drop to as low as 80% efficiency during the life of the belt.

Efficiency as applied to air handling equipment is the rate of the motor's energy as transferred to the driven fan. The lower the efficiency rating, the slower the fan speed, which results in lower air movement and longer cycle/run times for the HVAC Equipment - thus increasing electrical consumption.

Once properly tensioned, Megadyne Synchronous Belts maintain a 98% efficiency rating throughout the life of the belt and without the need for costly maintenance.

Electrical savings due to the constant 98% efficiency standard of a synchronous belt are significant in many applications.

What is the annual energy and dollar savings if a 93% efficient V-belt is replaced with a 98% efficient synchronous belt?

A Department of Energy report compares a continuously operating, 100HP, supply-air fan motor at 93% efficiency operating at an average load of 75% while consuming 527,000 kWh annually. Electricity is priced at \$0.05/kWh.

$$\begin{aligned} \text{Energy Savings} &= \text{Annual Energy Use} \times (1 - 93\%/98\%) = \\ &= 527,000 \text{ kWh/year} \times (1 - 93/98) = 26,888 \text{ kWh/year} \\ \text{Annual Cost Savings} &= 26,888 \text{ kWh} \times \$0.05 = \$1,345 \end{aligned}$$

NOTE: Synchronous belts may not be suitable for every drive. Where a v-belt must be used it is also an option to replace wrapped v-belts with raw edge cogged belts for an average 95% efficiency. This is an economical upgrade and additionally allows the use of existing pulleys.



CONDUCT A SURVEY OF YOUR DRIVES

Contact your Megadyne Distributor to conduct a survey of your belt driven equipment and identify energy savings potential on your drives!



Fractional Horsepower (FHP) 3L Section

Fractional Horsepower (FHP) V-Belts are ideal for HVAC equipment, appliances, outdoor power equipment, lawn & garden, and various industrial applications. Generally, 3L FHP belts are used individually on drives of 1 horsepower or less.



WARNING: This product can expose you to chemicals including carbon black, which is known to the State of California to cause cancer or birth defects or other reproductive harm. For more information visit www.P65WARNINGS.ca.gov

PART NOMENCLATURE

3L130

- 3** = top width in eighths of an inch = 3/8"
- L** = Light Duty (FHP)
- 130** = outside length in tenths of an inch = 13.0"

Features & Benefits

Oil & Heat Resistant

Durability in tough environments

Flexibility

Ideal for use with backside idlers

Static Dissipating

Safe operation in potentially dangerous atmosphere

Construction

Compound

Natural rubber/SBR

Cord

Polyester

Cover

Cotton/polyester blend

Technical Info

Applications

Extraction fans, ventilation fans, general HVAC equipment -

Engineering Standards

Conforms to ARPM standard IP-23

Temperature Range

-22°F/+176°F (-30°C/+80°C)

Recommended Pulleys

Use pulleys made to ARPM standards

Note

Effective length is approximately equal to outside length

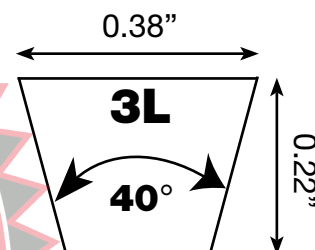

3L - AVAILABLE SIZES

Additional lengths may be available - contact Megadyne for sizes not listed

Belt Number	Outside Length (inch)	Approx. Weight (lbs.)	Belt Number	Outside Length (inch)	Approx. Weight (lbs.)	Belt Number	Outside Length (inch)	Approx. Weight (lbs.)	Belt Number	Outside Length (inch)	Approx. Weight (lbs.)
3L130	13.0	0.04	3L290	29.0	0.10	3L450	45.0	0.15	3L610	61.0	0.20
3L140	14.0	0.04	3L300	30.0	0.10	3L460	46.0	0.15	3L620	62.0	0.20
3L150	15.0	0.04	3L310	31.0	0.11	3L470	47.0	0.16	3L630	63.0	0.20
3L160	16.0	0.04	3L315	31.5	0.11	3L475	47.5	0.16	3L640	64.0	0.21
3L170	17.0	0.06	3L320	32.0	0.11	3L480	48.0	0.16	3L650	65.0	0.21
3L180	18.0	0.06	3L330	33.0	0.11	3L490	49.0	0.16	3L660	66.0	0.21
3L190	19.0	0.06	3L340	34.0	0.11	3L500	50.0	0.17	3L670	67.0	0.22
3L200	20.0	0.07	3L350	35.0	0.12	3L510	51.0	0.17	3L680	68.0	0.22
3L210	21.0	0.07	3L360	36.0	0.12	3L520	52.0	0.17	3L690	69.0	0.22
3L220	22.0	0.07	3L370	37.0	0.12	3L530	53.0	0.18	3L700	70.0	0.22
3L230	23.0	0.08	3L380	38.0	0.13	3L540	54.0	0.18	3L710	71.0	0.22
3L240	24.0	0.08	3L390	39.0	0.13	3L550	55.0	0.19	3L720	72.0	0.23
3L250	25.0	0.08	3L400	40.0	0.13	3L560	56.0	0.19	3L730	73.0	0.23
3L260	26.0	0.09	3L410	41.0	0.14	3L570	57.0	0.19	3L740	74.0	0.23
3L270	27.0	0.09	3L420	42.0	0.14	3L580	58.0	0.20	3L750	75.0	0.24
3L280	28.0	0.09	3L430	43.0	0.15	3L590	59.0	0.20	3L760	76.0	0.24
3L285	28.5	0.09	3L440	44.0	0.15	3L600	60.0	0.20	-	-	-

All items subject to minimum order requirements.

UniMatch® Classical Multi-Plus® A, B, C, D, E

Multi-Plus V-Belts are designed to perform in tandem in multiple V-Belt drives, maintaining drive efficiency and belt performance. Multi-Plus V-Belts are always matched, easy to install and maintain. Multi-Plus V-Belts come in a complete range of sizes, are anti-static and offer oil and heat resistance meeting ARPM requirements.



Dual Branding – A and B section belts up to 100" are Dual Branded clearly identifying both ARPM classical and fractional horsepower (FHP) sizes allowing consolidation of your classical and FHP inventory into one belt line – saving you money! No need to carry two separate product lines. The dual part number system is more than just labeling, too. FHP & Classical belts have the same top width dimension but classical profile is deeper, allowing more belt/pulley contact and reducing sheave wear.

Dual Branding Examples: A40 (4L420) --- B78 (5L810)



WARNING: This product can expose you to chemicals including carbon black, which is known to the State of California to cause cancer or birth defects or other reproductive harm. For more information visit www.P65WARNINGS.ca.gov

PART NOMENCLATURE

A15

A = 0.50" width x 0.31" thickness

15 = Inside length 15.0"

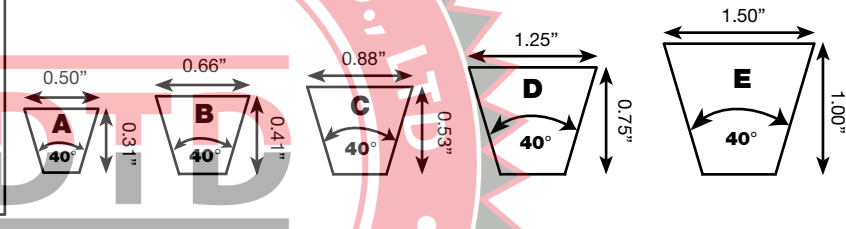

Features & Benefits

- UniMatch Construction:** Consistent performance in multiple V-Belt drives - ensures all belts will measure within ARPM matching standards
- Dual Branding:** A & B sections dual-branded with classical and FHP part numbers - reduces inventory by allowing you to discontinue 4L and 5L
- Oil & Heat Resistant:** Durability in tough environments

Construction

- Compound:** Natural rubber/SBR
- Cord:** Polyester
- Cover:** Cotton/polyester blend

Technical Info

- Applications** Extraction fans, exhaust fans, general HVAC Equipment
- Engineering Standards** Conforms to ARPM standard IP-20
- Temperature Range** -22°F/+176° (-300C/+800C)
- Recommended Pulleys** Use pulleys made to ARPM standards

All items subject to minimum order requirements.

Classical Multi-Plus® - A, B

AVAILABLE SIZES

Additional Lengths may be available. Contact Megadyne for sizes not listed.

A			A			A			A		
Belt Number	Outside Length (inch)	Approx. Weight (lbs.)	Belt Number	Outside Length (inch)	Approx. Weight (lbs.)	Belt Number	Outside Length (inch)	Approx. Weight (lbs.)	Belt Number	Outside Length (inch)	Approx. Weight (lbs.)
4L160	16.0	0.10	A53 (4L50)	55.0	0.30	A92 (4L940)	94.0	0.50	A162	164.0	1.10
A15 (4L170)	17.0	0.10	A54 (4L560)	56.0	0.30	A93 (4L950)	95.0	0.50	A173	175.0	1.15
A16 (4L180)	18.0	0.10	A55 (4L570)	57.0	0.30	A94 (4L960)	96.0	0.50	A180	182.0	1.15
A17 (4L190)	19.0	0.10	A56 (4L580)	58.0	0.30	A95 (4L970)	97.0	0.50	A196	198.0	1.31
A18 (4L200)	20.0	0.10	A57 (4L590)	59.0	0.30	A96 (4L980)	98.0	0.50	A197	199.0	1.31
A19 (4L210)	21.0	0.10	A58 (4L600)	60.0	0.30	A97 (4L990)	99.0	0.50	A210	212.0	1.35
A20 (4L220)	22.0	0.10	A59 (4L610)	61.0	0.30	A98 (4L1000)	100.0	0.50	A221	223.0	1.40
A21 (4L230)	23.0	0.10	A60 (4L620)	62.0	0.30	A99	101.0	0.50	A256	258.0	1.70
A22 (4L240)	24.0	0.15	A61 (4L630)	63.0	0.30	A100	102.0	0.50	A258	260.0	1.75
A23 (4L250)	25.0	0.20	A62 (4L640)	64.0	0.30	A101	103.0	0.50	B		
A24 (4L260)	26.0	0.20	A63 (4L650)	65.0	0.30	A103	105.0	0.50	5L220	22.0	0.40
A25 (4L270)	27.0	0.20	A64 (4L660)	66.0	0.30	A104	106.0	0.50	5L230	23.0	0.40
A26 (4L280)	28.0	0.20	A65 (4L670)	67.0	0.30	A105	107.0	0.50	B20	23.0	0.40
A27 (4L290)	29.0	0.20	A66 (4L680)	68.0	0.40	A106	108.0	0.55	B21 (5L240)	24.0	0.40
A28 (4L300)	30.0	0.20	A67 (4L690)	69.0	0.40	A107	109.0	0.57	B22 (5L250)	25.0	0.40
A29 (4L310)	31.0	0.20	A68 (4L700)	70.0	0.40	A108	110.0	0.60	B23 (5L260)	26.0	0.40
A30 (4L320)	32.0	0.20	A69 (4L710)	71.0	0.40	A109	111.0	0.65	B24 (5L270)	27.0	0.40
A31 (4L340)	33.0	0.20	A70 (4L720)	72.0	0.40	A110	112.0	0.70	B25 (5L280)	28.0	0.40
A32 (4L340)	34.0	0.20	A71 (4L730)	73.0	0.40	A111	113.0	0.75	B26 (5L290)	29.0	0.40
A33 (4L350)	35.0	0.20	A72 (4L740)	74.0	0.40	A112	114.0	0.80	B27 (5L300)	30.0	0.40
A34 (4L360)	36.0	0.20	A73 (4L750)	75.0	0.40	A113	115.0	0.80	B28 (5L310)	31.0	0.40
A35 (4L370)	37.0	0.20	A74 (4L760)	76.0	0.40	A114	116.0	0.80	B29 (5L320)	32.0	0.40
A36 (4L380)	38.0	0.20	A75 (4L770)	77.0	0.40	A115	117.0	0.80	B30 (5L330)	33.0	0.40
A37 (4L390)	39.0	0.20	A76 (4L780)	78.0	0.40	A116	118.0	0.80	B31 (5L340)	34.0	0.40
A38 (4L400)	40.0	0.20	A77 (4L790)	79.0	0.40	A118	120.0	0.80	B32 (5L350)	35.0	0.40
A39 (4L410)	41.0	0.20	A78 (4L800)	80.0	0.40	A119	121.0	0.80	B33 (5L360)	36.0	0.40
A40 (4L420)	42.0	0.20	A79 (4L810)	81.0	0.40	A120	122.0	0.80	B34 (5L370)	37.0	0.40
A41 (4L430)	43.0	0.20	A80 (4L820)	82.0	0.40	A124	126.0	0.80	B35 (5L380)	38.0	0.40
A42 (4L440)	44.0	0.20	A81 (4L830)	83.0	0.40	A128	130.0	0.80	B36 (5L390)	39.0	0.40
A43 (4L450)	45.0	0.30	A82 (4L840)	84.0	0.40	A130	132.0	0.80	B37 (5L400)	40.0	0.40
A44 (4L460)	46.0	0.30	A83 (4L850)	85.0	0.40	A133	135.0	0.80	B38 (5L410)	41.0	0.40
A45 (4L470)	47.0	0.30	A84 (4L860)	86.0	0.40	A134	136.0	0.80	B39 (5L420)	42.0	0.40
A46 (4L480)	48.0	0.30	A85 (4L870)	87.0	0.40	A135	137.0	0.90	B40 (5L430)	43.0	0.40
A47 (4L490)	49.0	0.30	A86 (4L880)	88.0	0.40	A136	138.0	0.90	B41 (5L440)	44.0	0.40
A48 (4L500)	50.0	0.30	A87 (4L890)	89.0	0.40	A137	139.0	0.90	B42 (5L450)	45.0	0.40
A49 (4L510)	51.0	0.30	A88 (4L900)	90.0	0.40	A140	142.0	0.95	B43 (5L460)	46.0	0.40
A50 (4L520)	52.0	0.30	A89 (4L910)	91.0	0.40	A144	146.0	1.00	B44 (5L470)	47.0	0.40
A51 (4L530)	53.0	0.30	A90 (4L920)	92.0	0.40	A157	159.0	1.10	B45 (5L480)	48.0	0.40
A52 (4L540)	54.0	0.30	A91 (4L930)	93.0	0.50	A158	160.0	1.10	B46 (5L490)	49.0	0.50



WARNING: This product can expose you to chemicals including carbon black, which is known to the State of California to cause cancer or birth defects or other reproductive harm. For more information visit www.P65WARNINGS.ca.gov

Classical Multi-Plus® - B (continued)

AVAILABLE SIZES

Additional Lengths may be available. Contact Megadyne for sizes not listed.

B			B			B			B		
Belt Number	Outside Length (inch)	Approx. Weight (lbs.)	Belt Number	Outside Length (inch)	Approx. Weight (lbs.)	Belt Number	Outside Length (inch)	Approx. Weight (lbs.)	Belt Number	Outside Length (inch)	Approx. Weight (lbs.)
B47 (5L500)	50.0	0.50	B86 (5L890)	89.0	0.80	B128	131.0	1.30	B205	208.0	2.00
B48 (5L510)	51.0	0.50	B87 (5L900)	90.0	0.80	B130	133.0	1.30	B210	213.0	2.00
B49 (5L520)	52.0	0.50	B88 (5L910)	91.0	0.80	B131	134.0	1.30	B215	217.0	2.10
B50 (5L530)	53.0	0.50	B89 (5L920)	92.0	0.80	B132	135.0	1.30	B221	223.0	2.25
B51 (5L540)	54.0	0.50	B90 (5L930)	93.0	0.90	B133	136.0	1.30	B223	225.0	2.25
B52 (5L550)	55.0	0.50	B91 (5L940)	94.0	0.90	B134	137.0	1.30	B224	226.0	2.30
B53 (5L560)	56.0	0.50	B92 (5L950)	95.0	0.90	B135	138.0	1.30	B225	227.0	2.30
B54 (5L570)	57.0	0.50	B93 (5L960)	96.0	0.90	B136	139.0	1.30	B228	230.0	2.30
B55 (5L580)	58.0	0.60	B94 (5L970)	97.0	0.90	B138	141.0	1.30	B229	231.0	2.30
B56 (5L590)	59.0	0.60	B95 (5L980)	98.0	0.90	B140	143.0	1.30	B234	236.0	2.30
B57 (5L600)	60.0	0.60	B96 (5L990)	99.0	0.90	B141	144.0	1.30	B237	239.0	2.30
B58 (5L610)	61.0	0.60	B97 (5L1000)	100.0	0.90	B142	145.0	1.30	B240	242.0	2.30
B59 (5L620)	62.0	0.60	B98 (5L1010)	101.0	0.90	B144	147.0	1.40	B248	250.0	2.30
B60 (5L630)	63.0	0.60	B99 (5L1020)	102.0	1.00	B147	150.0	1.40	B253	255.0	2.30
B61 (5L640)	64.0	0.70	B100	103.0	1.00	B148	151.0	1.40	B255	257.0	2.30
B62 (5L650)	65.0	0.70	B101	104.0	1.00	B150	153.0	1.50	B259	261.0	2.30
B63 (5L660)	66.0	0.70	B102	105.0	1.00	B152	155.0	1.50	B265	267.0	2.30
B64 (5L670)	67.0	0.70	B103	106.0	1.00	B153	155.0	1.50	B270	272.0	2.30
B65 (5L680)	68.0	0.70	B104	107.0	1.00	B154	157.0	1.50	B276	278.0	2.70
B66 (5L690)	69.0	0.70	B105	108.0	1.00	B156	159.0	1.50	B285	287.0	2.70
B67 (5L700)	70.0	0.70	B106	109.0	1.00	B157	160.0	1.50	B292	294.0	2.70
B68 (5L710)	71.0	0.70	B107	110.0	1.00	B158	161.0	1.50	B293	295.0	2.70
B69 (5L720)	72.0	0.70	B108	111.0	1.00	B162	165.0	1.50	B300	302.0	2.70
B70 (5L730)	73.0	0.70	B109	112.0	1.00	B163	166.0	1.50	B315	317.0	2.90
B71 (5L740)	74.0	0.70	B110	113.0	1.10	B165	168.0	1.50	B330	332.0	2.90
B72 (5L750)	75.0	0.70	B111	114.0	1.10	B168	171.0	1.50	B333	335.0	2.90
B73 (5L760)	76.0	0.70	B112	115.0	1.10	B170	173.0	1.50	B345	347.0	3.00
B74 (5L770)	77.0	0.70	B113	116.0	1.15	B173	176.0	1.50	B360	362.0	3.20
B75 (5L780)	78.0	0.70	B114	117.0	1.20	B175	178.0	1.50	B394	396.0	4.00
B76 (5L790)	79.0	0.70	B115	118.0	1.20	B177	180.0	1.50	B433	435.0	4.20
B77 (5L800)	80.0	0.80	B116	119.0	1.20	B180	183.0	1.50	B472	474.0	4.60
B78 (5L810)	81.0	0.80	B118	121.0	1.20	B182	185.0	1.50			
B79 (5L820)	82.0	0.80	B120	123.0	1.20	B184	187.0	1.50			
B80 (5L830)	83.0	0.80	B122	125.0	1.20	B188	191.0	1.80			
B81 (5L840)	84.0	0.80	B123	126.0	1.20	B190	193.0	1.90			
B82 (5L850)	85.0	0.80	B124	127.0	1.20	B192	195.0	2.00			
B83 (5L860)	86.0	0.80	B125	128.0	1.20	B195	198.0	2.00			
B84 (5L870)	87.0	0.80	B126	129.0	1.20	B197	200.0	2.00			
B85 (5L880)	88.0	0.80	B127	130.0	1.20	B204	207.0	2.00			

 **WARNING:** This product can expose you to chemicals including carbon black, which is known to the State of California to cause cancer or birth defects or other reproductive harm. For more information visit www.P65WARNINGS.ca.gov

Classical Multi-Plus® - C

AVAILABLE SIZES

Additional Lengths may be available. Contact Megadyne for sizes not listed.

C		
Belt Number	Outside Length (inch)	Approx. Weight (lbs.)
C41	45.0	0.80
C43	47.0	0.80
C45	49.0	0.80
C46	40.0	0.80
C47	51.0	0.80
C48	52.0	0.90
C50	54.0	0.90
C51	55.0	0.90
C52	56.0	0.90
C53	57.0	0.90
C54	58.0	0.90
C55	59.0	1.00
C56	60.0	1.02
C57	61.0	1.04
C58	62.0	1.06
C59	63.0	1.08
C60	64.0	1.10
C62	66.0	1.10
C63	67.0	1.10
C64	68.0	1.10
C65	69.0	1.10
C66	70.0	1.10
C67	71.0	1.10
C68	72.0	1.10
C69	73.0	1.15
C70	74.0	1.20
C72	76.0	1.20
C73	77.0	1.20
C75	79.0	1.20
C78	82.0	1.20
C79	83.0	1.20
C80	84.0	1.20
C81	85.0	1.30
C83	87.0	1.30
C85	89.0	1.40
C86	90.0	1.40
C87	91.0	1.40
C88	92.0	1.40
C90	94.0	1.40

C		
Belt Number	Outside Length (inch)	Approx. Weight (lbs.)
C92	96.0	1.40
C93	97.0	1.40
C94	98.0	1.50
C96	100.0	1.50
C97	101.0	1.80
C98	102.0	1.80
C99	103.0	1.80
C100	104.0	1.90
C101	105.0	1.90
C102	106.0	1.90
C103	107.0	1.90
C104	108.0	1.90
C105	109.0	1.90
C106	110.0	1.90
C108	112.0	1.90
C109	113.0	1.90
C110	114.0	1.90
C112	116.0	2.00
C115	119.0	2.00
C116	120.0	2.00
C118	122.0	2.10
C120	124.0	2.20
C124	128.0	2.25
C126	130.0	2.30
C128	132.0	2.40
C130	134.0	2.40
C132	136.0	2.40
C134	138.0	2.40
C136	140.0	2.40
C138	142.0	2.40
C140	144.0	2.40
C141	145.0	2.40
C142	146.0	2.40
C143	147.0	2.40
C144	148.0	2.40
C148	152.0	2.60
C150	154.0	2.60
C152	156.0	2.60
C153	157.0	2.60

C		
Belt Number	Outside Length (inch)	Approx. Weight (lbs.)
C154	158.0	2.70
C155	159.0	2.70
C156	160.0	2.70
C158	162.0	2.70
C159	163.0	2.70
C160	164.0	2.70
C162	166.0	2.70
C166	170.0	2.70
C168	172.0	2.70
C172	176.0	3.00
C173	177.0	3.00
C175	179.0	3.00
C177	181.0	3.10
C180	184.0	3.20
C185	189.0	3.20
C188	192.0	3.20
C190	194.0	3.20
C195	199.0	3.40
C200	204.0	3.50
C202	206.0	3.60
C204	208.0	3.60
C207	211.0	3.65
C208	212.0	3.65
C210	214.0	3.70
C220	222.0	3.70
C225	227.0	4.40
C228	230.0	4.40
C238	240.0	4.80
C240	242.0	4.80
C245	247.0	5.00
C246	248.0	5.00
C248	250.0	5.00
C255	257.0	5.00
C270	272.0	5.40
C276	278.0	5.40
C280	282.0	5.50
C285	287.0	5.60
C297	299.0	5.60
C300	302.0	5.60

C		
Belt Number	Outside Length (inch)	Approx. Weight (lbs.)
C303	305.0	5.60
C314	316.0	5.60
C315	317.0	5.60
C330	332.0	5.70
C345	347.0	6.60
C360	362.0	7.00
C390	392.0	7.40
C420	422.0	7.80
C480	482.0	7.90

WARNING: This product can expose you to chemicals including carbon black, which is known to the State of California to cause cancer or birth defects or other reproductive harm. For more information visit www.P65WARNINGS.ca.gov

All items subject to minimum order requirements.

Classical Multi-Plus® - D, E

AVAILABLE SIZES

Additional Lengths may be available. Contact Megadyne for sizes not listed.

D		
Belt Number	Outside Length (inch)	Approx. Weight (lbs.)
D90	95.0	3.40
D105	110.0	4.00
D115	120.0	4.30
D120	125.0	4.50
D128	133.0	4.80
D132	137.0	5.00
D136	141.0	5.20
D144	149.0	5.40
D158	163.0	6.00
D162	167.0	6.10
D171	176.0	6.40
D173	178.0	6.50
D180	185.0	6.80
D195	200.0	7.30
D205	210.0	7.90
D210	215.0	8.40
D225	228.0	8.40
D240	243.0	9.00
D248	251.0	9.00

D		
Belt Number	Outside Length (inch)	Approx. Weight (lbs.)
D255	258.0	9.50
D270	273.0	10.00
D285	288.0	10.70
D300	303.0	11.20
D315	318.0	11.80
D330	333.0	12.40
D345	348.0	12.60
D355	358.0	13.00
D360	363.0	13.50
D390	393.0	14.60
D394	397.0	14.80
D420	423.0	15.80
D441	444.0	16.50
D450	453.0	16.95
D480	483.0	18.10
D540	543.0	20.20
D600	603.0	22.40
D660	663.0	24.80

E		
Belt Number	Outside Length (inch)	Approx. Weight (lbs.)
E144	150.0	9.30
E180	186.0	9.30
E195	201.0	10.00
E210	216.0	12.00
E225	231.0	13.00
E240	246.0	13.50
E270	276.0	15.30
E300	306.0	17.00
E310	316.0	17.60
E330	336.0	18.80
E360	366.0	20.40
E390	396.0	22.10
E420	426.0	23.80
E441	447.0	25.00
E460	466.0	26.00
E480	486.0	28.00



WARNING: This product can expose you to chemicals including carbon black, which is known to the State of California to cause cancer or birth defects or other reproductive harm. For more information visit www.P65WARNINGS.ca.gov



All items subject to minimum order requirements.



UniMatch® Cogged Raw Edge Classical V-Belts - AX, BX, CX **Oil & Heat Resistant/Static Dissipating**

Megadyne V-belts in raw edge, cogged construction are ideally suited to high-speed compact drives. These belts all have the UniMatch feature ensuring belts of matched length when used on drives requiring the use of multiple, or a set of belts.

Cogged Raw Edge V-belts are designated by a letter indicating belt section, followed by "X" which signifies cogged, raw edge construction that has greater power capacity than standard wrapped construction.



WARNING: This product can expose you to chemicals including carbon black, which is known to the State of California to cause cancer or birth defects or other reproductive harm. For more information visit www.P65WARNINGS.ca.gov

PART NOMENCLATURE

AX22

- A** = 0.5" Width x 0.31" Thickness
- X** = Raw edge sidewalls, cogged construction
- 22** = ARPM Standard length designation

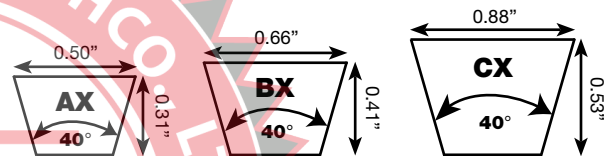

Features & Benefits

- Raw Edge Sidewalls** Eliminates slippage and increases efficiency versus wrapped V-belts and saves energy
- UniMatch Construction** Consistent performance in multiple V-belt drives and ensures all belts of the same size measure within ARPM matching limits
- Oil & Heat Resistant** Better than standard belts in oily environments (occasional splash) and higher ambient temperatures

Construction

- Compound** Chloroprene
- Cord** Polyester
- Top Fabric** Cotton/polyester blend

Technical Info

- Applications** HVAC Equipment where limited slippage is desired. Extraction fans, ventilation fans, general HVAC equipment.
- Engineering Standards** Conforms to ARPM standard IP-20
- Temperature Range** -22°F/+194°F (-30°C/+90°C)
- Recommended Pulleys** Use pulleys made to ARPM standards

All items subject to minimum order requirements.

UniMatch® Cogged Raw Edge Classical AX, BX, CX

AVAILABLE SIZES

Additional Lengths may be available. Contact Megadyne for sizes not listed.

AX			AX/BX			BX			CX		
Belt Number	Outside Length (inch)	Approx. Weight (lbs.)	Belt Number	Outside Length (inch)	Approx. Weight (lbs.)	Belt Number	Outside Length (inch)	Approx. Weight (lbs.)	Belt Number	Outside Length (inch)	Approx. Weight (lbs.)
AX22	24.0	0.17	AX80	82.0	0.52	BX71	74.0	0.78	CX51	55.0	1.07
AX23	25.0	0.17	AX84	86.0	0.54	BX72	75.0	0.79	CX60	64.0	1.24
AX24	26.0	0.17	AX85	87.0	0.55	BX73	76.0	0.80	CX68	72.0	1.39
AX25	27.0	0.18	AX86	88.0	0.56	BX74	77.0	0.81	CX71	75.0	1.45
AX26	28.0	0.18	AX90	92.0	0.59	BX75	78.0	0.82	CX73	77.0	1.49
AX27	29.0	0.18	AX92	94.0	0.61	BX76	79.0	0.83	CX74	78.0	1.51
AX28	30.0	0.19	AX96	98.0	0.62	BX77	80.0	0.85	CX75	79.0	1.53
AX29	31.0	0.20	AX105	107.0	0.68	BX78	81.0	0.86	CX76	80.0	1.55
AX30	32.0	0.20	AX108	108.0	0.70	BX79	82.0	0.87	CX77	81.0	1.57
AX31	33.0	0.21	AX110	112.0	0.71	BX80	83.0	0.88	CX78	82.0	1.59
AX32	34.0	0.21	AX112	114.0	0.73	BX81	84.0	0.89	CX79	83.0	1.61
AX33	35.0	0.22	AX120	122.0	0.74	BX82	85.0	0.90	CX80	84.0	1.63
AX34	36.0	0.23	AX128	130.0	0.78	BX83	86.0	0.91	CX81	85.0	1.64
AX35	37.0	0.24	AX136	138.0	0.82	BX84	87.0	0.92	CX82	86.0	1.67
AX36	38.0	0.24	BX			BX85	88.0	0.93	CX83	87.0	1.69
AX37	39.0	0.25	BX30	33.0	0.38	BX86	89.0	0.93	CX84	88.0	1.71
AX38	40.0	0.26	BX31	34.0	0.39	BX87	90.0	0.93	CX85	89.0	1.72
AX39	41.0	0.26	BX32	35.0	0.39	BX88	91.0	0.95	CX86	90.0	1.75
AX40	42.0	0.26	BX33	36.0	0.39	BX89	92.0	0.96	CX87	91.0	1.79
AX41	43.0	0.27	BX34	37.0	0.39	BX90	93.0	0.98	CX88	92.0	1.79
AX42	44.0	0.28	BX35	38.0	0.40	BX91	94.0	0.99	CX89	93.0	1.81
AX43	45.0	0.29	BX36	39.0	0.42	BX92	95.0	1.00	CX90	94.0	1.81
AX44	46.0	0.30	BX37	40.0	0.43	BX93	96.0	1.01	CX96	100.0	1.93
AX45	47.0	0.31	BX38	41.0	0.43	BX94	97.0	1.02	CX105	109.0	2.10
AX46	48.0	0.31	BX39	42.0	0.45	BX95	98.0	1.03	CX109	113.0	2.18
AX47	49.0	0.31	BX40	43.0	0.46	BX96	99.0	1.05	CX112	116.0	2.24
AX48	50.0	0.32	BX41	44.0	0.47	BX97	100.0	1.06	CX115	119.0	2.29
AX49	51.0	0.33	BX42	45.0	0.48	BX98	101.0	1.07	CX120	124.0	2.39
AX50	52.0	0.33	BX43	46.0	0.49	BX99	102.0	1.08	CX123	127.0	2.40
AX51	53.0	0.34	BX44	47.0	0.50	BX100	103.0	1.09	CX128	132.0	2.42
AX52	54.0	0.35	BX45	48.0	0.51	BX103	106.0	1.12	CX133	137.0	2.47
AX53	55.0	0.35	BX46	49.0	0.52	BX105	108.0	1.14	CX136	140.0	2.49
AX54	56.0	0.36	BX47	50.0	0.53	BX108	111.0	1.17	CX144	148.0	2.63
AX55	57.0	0.36	BX48	51.0	0.54	BX112	115.0	1.22	CX150	154.0	2.75
AX56	58.0	0.37	BX49	52.0	0.55	BX113	116.0	1.22	CX158	162.0	2.90
AX57	59.0	0.37	BX50	53.0	0.56	BX115	118.0	1.25	CX162	166.0	2.95
AX58	60.0	0.38	BX51	54.0	0.57	BX116	119.0	1.26	CX173	177.0	3.15
AX59	61.0	0.40	BX52	55.0	0.58	BX120	123.0	1.30	CX180	184.0	3.27
AX60	62.0	0.40	BX53	56.0	0.59	BX124	127.0	1.30	CX187	191.0	3.40
AX61	63.0	0.40	BX54	57.0	0.60	BX128	131.0	1.30	CX190	194.0	3.46
AX62	64.0	0.41	BX55	58.0	0.61	BX133	136.0	1.34	CX195	199.0	3.55
AX63	65.0	0.41	BX56	59.0	0.62	BX136	139.0	1.37	CX210	214.0	3.77
AX64	66.0	0.42	BX57	60.0	0.63	BX140	143.0	1.40	CX240	243.0	4.30
AX65	67.0	0.43	BX58	61.0	0.64	BX144	147.0	1.45	CX255	258.0	4.58
AX66	68.0	0.43	BX59	62.0	0.65	BX150	153.0	1.51	CX270	273.0	4.85
AX67	69.0	0.44	BX60	63.0	0.66	BX158	161.0	1.59			
AX68	70.0	0.45	BX61	64.0	0.67	BX162	165.0	1.63			
AX69	71.0	0.46	BX62	65.0	0.68	BX173	176.0	1.74			
AX70	72.0	0.46	BX63	66.0	0.69	BX180	183.0	1.81			
AX71	73.0	0.47	BX64	67.0	0.70	BX195	198.0	1.96			
AX72	74.0	0.48	BX65	68.0	0.71	BX210	213.0	2.10			
AX73	75.0	0.48	BX66	69.0	0.72	BX225	227.0	2.30			
AX75	77.0	0.49	BX67	70.0	0.73	BX240	242.0	2.36			
AX76	78.0	0.50	BX68	71.0	0.74	BX255	257.0	2.50			
AX78	80.0	0.51	BX69	72.0	0.75	BX270	272.0	2.64			
AX80	82.0	0.52	BX70	73.0	0.76						



WARNING: This product can expose you to chemicals including carbon black, which is known to the State of California to cause cancer or birth defects or other reproductive harm. For more information visit www.P65WARNINGS.ca.gov

V-BELTS



UniMatch® Deep Wedge - 3V, 5V, 8V Oil & Heat Resistant/Static Dissipating

A narrower, deeper, cross section than classical V-belts with more efficient load carrying characteristics and higher power capability, allowing for smaller, more compact drives. These belts feature UniMatch construction, which eliminates the need for belt set matching.

Deep Wedge V-belts are identified by a number and letter specifying the belt section and a number giving the outside length in inches multiplied by 10 - **Example: 3V250**.



WARNING: This product can expose you to chemicals including carbon black, which is known to the State of California to cause cancer or birth defects or other reproductive harm. For more information visit www.P65WARNINGS.ca.gov

PART NOMENCLATURE

3V250

3V = 0.38" width x 0.31" thickness
250 = Outside length in tenths of an inch = 25.0"

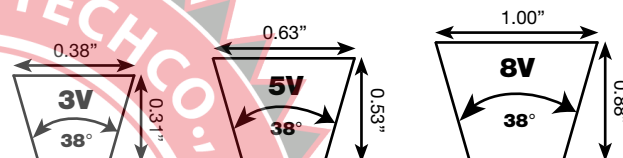

Features & Benefits

- High Power Capability** Higher power with a more compact drive
- UniMatch® Construction** Consistent performance in multiple V-belt drives and ensures all belts of the same size measure within ARPM matching limits
- Oil & Heat Resistant** Standard construction belts that deliver excellent performance

Construction

- Compound** Natural Rubber/SBR
- Cord** Polyester
- Cover** Cotton/polyester blend

Technical Info

- Applications** HVAC equipment where high power transmission is required. Extraction fans, ventilation fans, general HVAC equipment
- Engineering Standards** Conforms to ARPM standard IP-22
- Temperature Range** -22°F/+176°F (-30°C/+80°C)
- Recommended Pulleys** Use pulleys made to ARPM standards

All items subject to minimum order requirements.

UniMatch® Deep Wedge - 3V, 5V, 8V

AVAILABLE SIZES

Additional Lengths may be available. Contact Megadyne for sizes not listed.

3V		
Belt Number	Outside Length (inch)	Approx. Weight (lbs.)
3V250	25.0	0.10
3V265	26.5	0.10
3V280	28.0	0.10
3V300	30.0	0.10
3V315	31.5	0.10
3V335	33.5	0.20
3V355	35.5	0.20
3V375	37.5	0.20
3V400	40.0	0.20
3V425	42.5	0.20
3V450	45.0	0.20
3V475	47.5	0.20
3V500	50.0	0.20
3V530	53.0	0.30
3V560	56.0	0.30
3V600	60.0	0.30
3V630	63.0	0.30
3V650	65.0	0.30
3V670	67.0	0.30
3V710	71.0	0.30
3V730	73.0	0.30
3V750	75.0	0.30
3V800	80.0	0.30
3V830	83.0	0.35
3V850	85.0	0.40
3V900	90.0	0.40
3V950	95.0	0.40
3V1000	100.0	0.40
3V1060	106.0	0.40
3V1120	112.0	0.50
3V1180	118.0	0.50
3V1250	125.0	0.60
3V1320	132.0	0.60
3V1400	140.0	0.70

5V		
Belt Number	Outside Length (inch)	Approx. Weight (lbs.)
5V500	50.0	0.60
5V530	53.0	0.70
5V560	56.0	0.70
5V600	60.0	0.70
5V630	63.0	0.70
5V670	67.0	0.80
5V710	71.0	0.80
5V750	75.0	0.80
5V800	80.0	0.90
5V850	85.0	0.90
5V900	90.0	0.90
5V950	95.0	0.90
5V1000	100.0	1.10
5V1060	106.0	1.10
5V1120	112.0	1.20
5V1180	118.0	1.30
5V1250	125.0	1.30
5V1320	132.0	1.40
5V1400	140.0	1.50
5V1500	150.0	1.60
5V1600	160.0	1.70
5V1630	163.0	1.80
5V1700	170.0	1.90
5V1800	180.0	2.20
5V1900	190.0	2.20
5V2000	200.0	2.20
5V2120	212.0	2.40
5V2240	224.0	2.70
5V2360	236.0	2.80
5V2500	250.0	3.00
5V2650	265.0	3.10
5V2800	280.0	3.30
5V3000	300.0	3.50
5V3150	315.0	3.80
5V3350	335.0	3.90
5V3550	355.0	4.00

8V		
Belt Number	Outside Length (inch)	Approx. Weight (lbs.)
8V1000	100.0	3.50
8V1060	106.0	3.70
8V1120	112.0	3.90
8V1180	118.0	4.20
8V1250	125.0	4.40
8V1320	132.0	4.70
8V1400	140.0	4.90
8V1500	150.0	5.20
8V1600	160.0	5.60
8V1700	170.0	5.90
8V1800	180.0	6.30
8V1900	190.0	6.70
8V2000	200.0	7.00
8V2120	212.0	7.50
8V2240	224.0	7.90
8V2360	236.0	8.30
8V2500	250.0	8.80
8V2550	255.0	9.00
8V2650	265.0	9.30
8V2800	280.0	9.80
8V3000	300.0	10.50
8V3150	315.0	11.10
8V3300	330.0	11.60
8V3350	335.0	11.80
8V3550	355.0	12.50
8V3600	360.0	12.90
8V3750	375.0	13.30
8V4000	400.0	14.00
8V4250	425.0	14.90
8V4500	450.0	15.80
8V4750	475.0	16.40
8V5000	500.0	17.20
8V5600	560.0	19.00



WARNING: This product can expose you to chemicals including carbon black, which is known to the State of California to cause cancer or birth defects or other reproductive harm. For more information visit www.P65WARNINGS.ca.gov

V-BELTS



UniMatch® Cogged Raw Edge Deep Wedge 3VX, 5VX Oil & Heat Resistant/Static Dissipating

UniMatch Cogged Raw Edge construction further increases the effective power transmission of Deep Wedge V-belts. These cogged deep wedge UniMatch V-belts limit slippage and need no belt set matching when used in multiple belt drives.

Unimatch Cogged Raw Edge Deep Wedge V-belts are identified by a number followed by two letters indicating belt cross section and cogged construction. The number following is the outside length in inches multiplied by 10 - **Example 3VX250**.



WARNING: This product can expose you to chemicals including carbon black, which is known to the State of California to cause cancer or birth defects or other reproductive harm. For more information visit www.P65WARNINGS.ca.gov

Part Nomenclature

3VX250

3V	=	0.38" Top Width x 0.31" Thickness
X	=	Raw edge sidewalls and cogged
250	=	Outside length in tenths of an inch = 25.0"

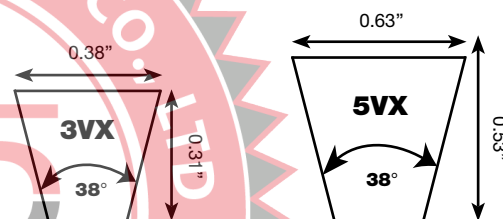

Features & Benefits

High Power Capability

Higher power with a more compact drive

UniMatch Construction

Provides dimensional stability - Assures all belts are within ARPM matching limits

Oil & Heat Resistant

Deliver excellent performance on demanding drives

Construction

Compound	Chloroprene
Cord	Polyester
Cover	Cotton/polyester blend

Technical Info

Applications

HVAC equipment where limited slippage and high power transmission is required. Extraction fans, ventilation fans, general HVAC equipment

Engineering Standards

Conforms to ARPM standard IP-22

Temperature Range

-22°F/+194°F (-30°C/+90°C)

Recommended Pulleys

Use pulleys made to ARPM standards

All items subject to minimum order requirements.

UniMatch® Cogged Raw Edge Deep Wedge 3VX, 5VX



AVAILABLE SIZES

Additional Lengths may be available. Contact Megadyne for sizes not listed.

3VX		
Belt Number	Outside Length (inch)	Approx. Weight (lbs.)
3VX250	25.0	0.10
3VX265	26.5	0.10
3VX280	28.0	0.10
3VX290	29.0	0.10
3VX300	30.0	0.10
3VX315	31.5	0.10
3VX335	33.5	0.20
3VX355	35.5	0.20
3VX375	37.5	0.20
3VX390	39.0	0.20
3VX400	40.0	0.20
3VX425	42.5	0.20
3VX450	45.0	0.20
3VX475	47.5	0.20
3VX500	50.0	0.20
3VX530	53.0	0.20
3VX560	56.0	0.20
3VX600	60.0	0.30
3VX630	63.0	0.30
3VX670	67.0	0.30
3VX710	71.0	0.30
3VX750	75.0	0.30
3VX800	80.0	0.40
3VX850	85.0	0.40
3VX900	90.0	0.40
3VX950	95.0	0.40
3VX1000	100.0	0.40
3V1060	106.0	0.50
3VX1120	112.0	0.50
3VX1180	118.0	0.60
3VX1250	125.0	0.60
3VX1320	132.0	0.70
3VX1400	140.0	0.70

5VX		
Belt Number	Outside Length (inch)	Approx. Weight (lbs.)
5VX450	45.0	0.55
5VX470	47.0	0.60
5VX500	50.0	0.60
5VX510	51.0	0.65
5VX530	53.0	0.70
5VX540	54.0	0.70
5VX550	55.0	0.70
5VX560	56.0	0.70
5VX570	57.0	0.70
5VX580	58.0	0.70
5VX590	59.0	0.70
5VX600	60.0	0.70
5VX610	61.0	0.80
5VX630	63.0	0.80
5VX650	65.0	0.80
5VX670	67.0	0.80
5VX680	68.0	0.80
5VX690	69.0	0.80
5VX710	71.0	0.80
5VX730	73.0	0.80
5VX740	74.0	0.80
5VX750	75.0	0.80
5VX780	78.0	0.85
5VX800	80.0	0.90
5VX810	81.0	0.90

5VX		
Belt Number	Outside Length (inch)	Approx. Weight (lbs.)
5VX830	83.0	0.90
5VX840	84.0	0.90
5VX850	85.0	0.90
5VX860	86.0	0.90
5VX880	88.0	0.90
5VX900	90.0	1.00
5VX950	95.0	1.10
5VX960	96.0	1.10
5VX1000	100.0	1.20
5VX1030	103.0	1.20
5VX1060	106.0	1.20
5VX1080	108.0	1.30
5VX1120	112.0	1.30
5VX1150	115.0	1.40
5VX1180	118.0	1.40
5VX1230	123.0	1.50
5VX1250	125.0	1.50
5VX1320	132.0	1.60
5VX1400	140.0	1.70
5VX1500	150.0	1.80
5VX1600	160.0	1.90
5VX1700	170.0	2.00
5VX1800	180.0	2.10
5VX1900	190.0	2.30
5VX2000	200.0	2.40



WARNING: This product can expose you to chemicals including carbon black, which is known to the State of California to cause cancer or birth defects or other reproductive harm. For more information visit www.P65WARNINGS.ca.gov

All items subject to minimum order requirements.

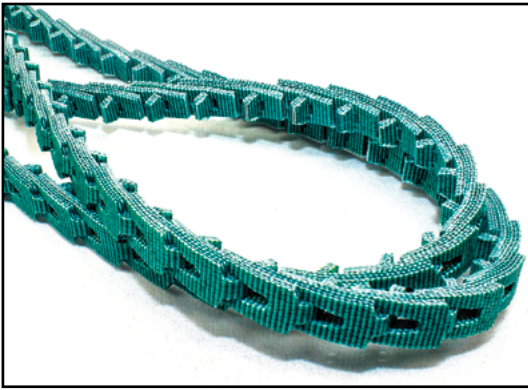

Accu-Link® Detachable Tab Link Type V-Belt The Ideal V-Belt Alternative!

Accu-Link is an alternative to conventional rubber belts in many applications. Made endless with a single twist, an open length of belt can be wrapped around pulleys in hard-to-fit applications yielding fast belt replacement. Additionally, Accu-Link's high strength polyester fabric link design offers high tensile strength and reduces vibration. Accu-Links's urethane impregnation offers terrific oil and wear resistance.

Features & Benefits

- Durable Urethane Coating
- Rugged Polyester Fabric
- Assemble To Any Length
- Easy "No Tools" Assembly
- Chemical/High-Temp Resistance
- Link Construction
- Smooth Operation
- Versatile
- Horsepower Capacity
- Interchangeability

- Increased life and durability
- Strength and longer life; maximum horsepower
- Reduces inventory
- Assembles by hand
- Dependable in harsh environments
- Rolls onto drive pulleys like chain - no cords to break.
- Reduced vibration over conventional V-belts
- Can be used in any industry, hundreds of applications
- Power ratings equal to conventional V-belts
- Uses existing standard pulleys

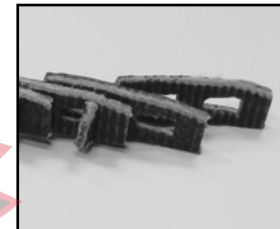
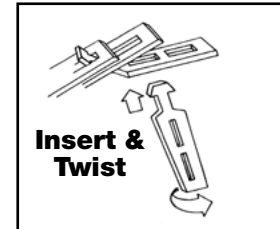

Construction

Rugged polyester fabric impregnated with premium urethane coating

Technical Info

Applications

For use in applications where it's difficult to install an endless belt, avoiding costly labor-intensive machine dis-assembly. Ideal for use on mobile service vehicles where carrying a large inventory of belts is not practical. Can be used either as singles or on multiple belt drives. Extraction fans, exhaust fans, General HVAC equipment and dehumidifier desiccant wheels.

Engineering Standards

None (No engineering standard exists for link-type belting)

Recommended Pulleys

Use pulleys made to ARPM standards

Temperature Range

-13°F/+176°F (-25°C/+80°C)

Belt Type	Part Number	Length (feet)	Weight Per Foot (lbs.)	Packaging
3L	3L-LINK-5	5	0.50	5 ft. in one sleeve
	3L-LINK-25	25	0.50	25 ft. in one carton
	3L-LINK-100	100	0.50	100 ft. in one carton
A	A-LINK-5	5	0.60	5 ft. in one sleeve
	A-LINK-25	25	0.60	25 ft. in one carton
	A-LINK-100	100	0.60	100 ft. in one carton
B	B-LINK-6	6	0.90	6 ft. in one sleeve
	B-LINK-25	25	0.90	25 ft. in one carton
	B-LINK-100	100	0.90	100 ft. in one carton
C	C-LINK-25	25	0.17	25 ft. in one carton
CC	Also available in CC section by request - contact Megadyne			

All items subject to minimum order requirements.

Accu-Link® Detachable Tab Link Type V-Belt

NO SPECIAL TOOLS REQUIRED - ASSEMBLES IN SECONDS!

ASSEMBLY



1. Hold belt with tabs pointing outward.
2. Place end tabs through two links at once.
3. Flex belt further and insert second tab through end link by twisting tab with thumb.
4. Ensure tab returns to position across belt. Reverse belt so tabs run inside.

DISASSEMBLY



1. Hold belt upside down. Bend back as far as possible, hold with one hand. Twist one tab 90° parallel with slot.
2. Pull end of link over tab.
3. Rotate belt end with tab 90°.
4. Pull belt through the two links.

Installation

1. Before installing, turn belt inside out and couple the belt.
2. Place endless Accu-Link® V-Belt in the nearest small sheave groove.
3. Extend belt and place in the nearest large sheave groove.
4. Manually turn the Accu-Link® V-Belt until it is in groove all around drive. Do not jog motor.
5. Continue to manually work the belt from groove to groove.
6. Repeat until all grooves are filled.
7. Tension belts using the same method for equivalent size conventional rubber belt.

NOTE: Unlike conventional V-Belts, Accu-Link® can be rolled onto pulleys - no cords to break!

ACCU-LINK® COMPARATIVE LENGTH TABLES

3L (3/8") ACCU-LINK®

Part Number	Accu-Link® Length (inch)	Part Number	Accu-Link® Length (inch)	Part Number	Accu-Link® Length (inch)	Part Number	Accu-Link® Length (inch)	Part Number	Accu-Link® Length (inch)	Part Number	Accu-Link® Length (inch)
3L140	14	3L210	21	3L280	28	3L350	35	3L420	42	3L490	49
3L150	15	3L220	22	3L290	29	3L360	36	3L430	43	3L500	50
3L160	16	3L230	23	3L300	30	3L370	37	3L440	44	3L520	52
3L170	17	3L240	24	3L310	31	3L380	38	3L450	45	3L540	54
3L180	18	3L250	25	3L320	32	3L390	39	3L460	46	3L560	56
3L190	19	3L260	26	3L330	33	3L400	40	3L470	47	3L580	58
3L200	20	3L270	27	3L340	34	3L410	41	3L480	48	3L600	60

NOTE:

Accu-Link® lengths are approximate. Adjustments may be required (links removed) after initial run-in. Overall length measurement should be made after belt is assembled.

Accu-Link® Detachable Tab Link Type V-Belt

ACCU-LINK® COMPARATIVE LENGTH TABLES

A/4L (1/2") ACCU-LINK®																	
Part Number		Accu-Link® Length (inch)	Part Number		Accu-Link® Length (inch)	Part Number		Accu-Link® Length (inch)	Part Number		Accu-Link® Length (inch)	Part Number		Accu-Link® Length (inch)	Part Number		Accu-Link® Length (inch)
A19	4L210	21	A33	4L350	35	A47	4L490	49	A61	4L630	63	A75	4L770	77	A89	4L910	91
A20	4L220	22	A34	4L360	36	A48	4L500	50	A62	4L640	64	A76	4L780	78	A90	4L920	92
A21	4L230	23	A35	4L370	37	A49	4L510	51	A63	4L650	65	A77	4L790	79	A91	4L930	93
A22	4L240	24	A36	4L380	38	A50	4L520	52	A64	4L660	66	A78	4L800	80	A92	4L940	94
A23	4L250	25	A37	4L390	39	A51	4L530	53	A65	4L670	67	A79	4L810	81	A93	4L950	95
A24	4L260	26	A38	4L400	40	A52	4L540	54	A66	4L680	68	A80	4L820	82	A94	4L960	96
A25	4L270	27	A39	4L410	41	A53	4L550	55	A67	4L690	69	A81	4L830	83	A95	4L970	97
A26	4L280	28	A40	4L420	42	A54	4L560	56	A68	4L700	70	A82	4L840	84	A96	4L980	98
A27	4L290	29	A41	4L430	43	A55	4L570	57	A69	4L710	71	A83	4L850	85	A97	4L990	99
A28	4L300	30	A42	4L440	44	A56	4L580	58	A70	4L720	72	A84	4L860	86	A98	4L1000	100
A29	4L310	31	A43	4L450	45	A57	4L590	59	A71	4L730	73	A85	4L870	87	A99	---	101
A30	4L320	32	A44	4L460	46	A58	4L600	60	A72	4L740	74	A86	4L880	88	---	---	---
A31	4L330	33	A45	4L470	47	A58	4L610	61	A73	4L750	75	A87	4L890	89	---	---	---
A32	4L340	34	A46	4L480	48	A60	4L620	62	A74	4L760	76	A88	4L900	90	---	---	---

B/5L (21/32") ACCU-LINK®																	
Part Number		Accu-Link® Length (inch)	Part Number		Accu-Link® Length (inch)	Part Number		Accu-Link® Length (inch)	Part Number		Accu-Link® Length (inch)	Part Number		Accu-Link® Length (inch)	Part Number		Accu-Link® Length (inch)
B22	5L250	25	B36	5L390	39	B50	5L530	53	B64	5L670	67	B78	5L810	81	B92	5L950	95
B23	5L260	26	B37	5L400	40	B51	5L540	54	B65	5L680	68	B79	5L820	82	B93	5L960	96
B24	5L270	27	B38	5L410	41	B52	5L550	55	B66	5L690	69	B80	5L830	83	B94	5L970	97
B25	5L280	28	B39	5L420	42	B53	5L560	56	B67	5L700	70	B81	5L840	84	B95	5L980	98
B26	5L290	29	B40	5L430	43	B54	5L570	57	B68	5L710	71	B82	5L850	85	B96	5L990	99
B27	5L300	30	B41	5L440	44	B55	5L580	58	B69	5L720	72	B83	5L860	86	B97	---	100
B28	5L310	31	B42	5L450	45	B56	5L590	59	B70	5L730	73	B84	5L870	87	B98	---	101
B29	5L320	32	B43	5L460	46	B57	5L600	60	B71	5L740	74	B85	5L880	88	B99	---	102
B30	5L330	33	B44	5L470	47	B58	5L610	61	B72	5L750	75	B86	5L890	89	---	---	---
B31	5L340	34	B45	5L480	48	B59	5L620	62	B73	5L760	76	B87	5L900	90	---	---	---
B32	5L350	35	B46	5L490	49	B60	5L630	63	B74	5L770	77	B88	5L910	91	---	---	---
B33	5L360	36	B47	5L500	50	B61	5L640	64	B75	5L780	78	B89	5L920	92	---	---	---
B34	5L370	37	B48	5L510	51	B62	5L650	65	B76	5L790	79	B90	5L930	93	---	---	---
B35	5L380	38	B49	5L520	52	B63	5L660	66	B77	5L800	80	B91	5L940	94	---	---	---

NOTE: Accu-Link® lengths are approximate. Adjustments may be required (links removed) after initial run-in. Overall length measurement should be made after belt is assembled.



BANDED V-BELTS

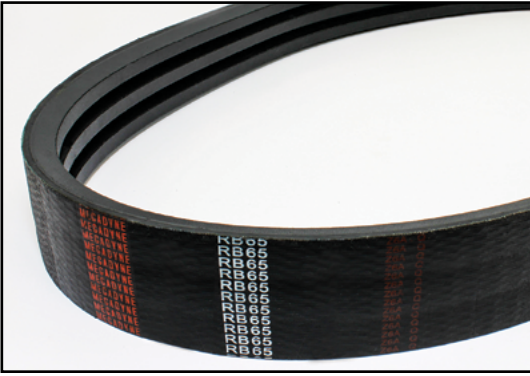

UniMatch® Banded V-Belts

RB, RC, RD

Oil & Heat Resistant/Static Dissipating

UniMatch Banded V-belts are available in Classical sections B, C and D, and feature the same premium construction as our single v-belt. Bonded together with a fabric-neoprene top band, these belts are often used on vertical shafts and where belt vibration, whipping and turn-over must be minimized.

In-between lengths (sizes not listed here) of the B, C and D sections are available, as are lengths up to 600 inches in the B and C sections by special order. Contact Megadyne for availability.

Banded Classical V-belts are specified by a number followed by a forward slash which indicates banded construction and number of ribs, and a letter/number combination indicating the base belt part number. **Example: 8/C90**

WARNING: This product can expose you to chemicals including carbon black, which is known to the State of California to cause cancer or birth defects or other reproductive harm.
For more information visit www.P65WARNINGS.ca.gov

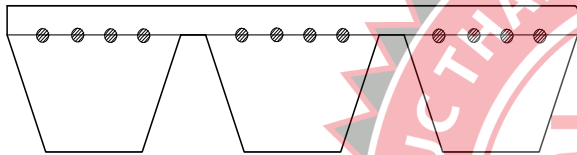

Part Nomenclature

8/C90

8 = One banded belt with 8 ribs
C = Indicates belt cross section
90 = ARPM Standard Length Designation

Features & Benefits

- Banded Construction** Fabric/Neoprene top band enhances stability and prevents belts from turning over or coming off the drive. Minimizes vibration.
- Static Dissipating** Safe operation in potentially dangerous atmosphere
- Oil & Heat Resistant** Durability in tough environments

Construction

- Compound** Natural Rubber/SBR
- Cord** Polyester
- Cover** Cotton/polyester blend
- Top Band** Fabric/Neoprene

Technical Info

- Applications** Air handlers, general HVAC equipment
- Engineering Standards** Conforms to ARPM standard IP-20
- Temperature Range** -22°F/+176°F (-20°C/+80°C)
- Recommended Pulleys** Use pulleys made to ARPM standards
- Special Lengths** In-between sizes (B,C,D) and sizes up to 600 inches (B, C) available by special order
- Note** 2 and 3 rib belts are not returnable

It is common practice for some belt suppliers to fill orders for banded V-belts by supplying separate bands (belts) that add up to the total number of ribs requested. Normal policy for Megadyne is to supply a one-piece banded V-belt unless otherwise requested. **Example: Order is for one belt with 8 ribs.** Some suppliers will send two belts with 4 ribs each. Megadyne will ship as ordered, one belt with 8 ribs, unless otherwise specified.

All items subject to minimum order requirements.

UniMatch® Banded V-Belts - RB, RC, RD

AVAILABLE SIZES

Additional Lengths may be available. Contact Megadyne for sizes not listed.

RB			RB			RC			RD		
Belt Number	Outside Length (inch)	Approx. Weight (lbs.)	Belt Number	Outside Length (inch)	Approx. Weight (lbs.)	Belt Number	Outside Length (inch)	Approx. Weight (lbs.)	Belt Number	Outside Length (inch)	Approx. Weight (lbs.)
RB46	49.8	0.70	RB100	103.8	1.36	RC60	65.4	1.44	RD112	118.6	4.70
RB48	51.8	0.70	RB101	104.8	1.34	RC68	73.4	1.65	RD120	126.6	5.00
RB51	54.8	0.70	RB103	106.8	1.39	RC71	76.4	1.68	RD128	134.6	5.30
RB52	55.8	0.70	RB105	108.8	1.43	RC75	80.4	1.80	RD138	144.6	5.80
RB53	56.8	0.72	RB108	111.8	1.47	RC80	85.4	1.85	RD144	150.6	6.00
RB55	58.8	0.74	RB109	112.8	1.50	RC81	86.4	1.92	RD158	164.6	6.60
RB56	59.8	0.75	RB112	115.8	1.54	RC85	90.4	2.04	RD162	168.6	6.80
RB57	60.8	0.76	RB114	117.8	1.58	RC87	92.4	2.09	RD173	179.6	7.20
RB58	61.8	0.77	RB116	119.8	1.61	RC90	95.4	2.16	RD180	186.6	7.50
RB59	62.8	0.79	RB118	121.8	1.60	RC96	101.4	2.30	RD195	201.6	7.90
RB60	63.8	0.82	RB120	123.8	1.68	RC100	105.4	2.40	RD210	216.6	8.70
RB61	64.8	0.83	RB124	127.8	1.75	RC105	110.4	2.52	RD225	229.1	9.40
RB62	65.8	0.84	RB128	131.8	1.78	RC109	114.4	2.60	RD240	244.1	10.00
RB63	66.8	0.86	RB130	133.8	1.80	RC112	117.4	2.68	RD255	259.1	10.60
RB64	67.8	0.87	RB133	136.8	1.81	RC120	125.4	2.88	RD270	274.1	11.20
RB65	68.8	0.88	RB136	139.8	1.84	RC126	131.4	3.04	RD285	289.1	11.80
RB66	69.8	0.89	RB138	141.8	1.90	RC128	133.4	3.07	RD300	304.1	12.50
RB67	70.8	0.90	RB141	144.8	1.92	RC136	141.4	3.26	RD315	319.1	13.10
RB68	71.8	0.92	RB144	147.8	1.95	RC144	149.4	3.45	RD330	334.1	13.70
RB70	73.8	0.95	RB148	151.8	2.00	RC158	163.4	3.79	RD345	349.1	14.40
RB71	74.8	0.97	RB150	153.8	2.05	RC162	167.4	3.88	RD360	364.1	14.90
RB72	75.8	0.98	RB154	157.8	2.09	RC173	178.4	4.15	RD390	394.1	16.20
RB75	78.8	1.00	RB158	161.8	2.14	RC180	185.4	4.32	RD420	424.1	17.50
RB77	80.8	1.02	RB160	163.8	2.18	RC195	200.4	4.68	RD480	484.1	20.00
RB78	81.8	1.04	RB162	165.8	2.20	RC204	209.4	4.90	RD540	544.1	22.50
RB79	82.8	1.06	RB173	176.8	2.35	RC210	215.4	5.04	RD600	604.1	25.00
RB80	83.8	1.08	RB180	183.8	2.44	RC225	228.4	5.40	RD660	664.1	27.50
RB81	84.8	1.10	RB184	187.8	2.50	RC240	243.4	5.76			
RB82	85.8	1.12	RB188	191.8	2.68	RC255	258.4	6.12			
RB83	86.8	1.15	RB190	193.8	2.75	RC270	273.4	6.48			
RB85	88.8	1.18	RB195	198.8	2.65	RC285	288.4	6.84			
RB88	91.8	1.21	RB210	213.8	2.85	RC300	303.4	7.20			
RB90	93.8	1.22	RB225	227.3	3.20	RC315	318.4	7.56			
RB93	96.8	1.26	RB240	242.3	3.26	RC330	333.4	7.92			
RB95	98.8	1.29	RB255	257.3	3.46	RC345	348.4	8.28			
RB96	99.8	1.30	RB270	272.3	3.67	RC360	363.4	8.64			
RB97	100.8	1.32	RB300	302.3	4.08	RC390	393.4	9.36			
RB99	102.8	1.35	RB315	317.3	4.28	RC420	423.4	10.80			

WARNING: This product can expose you to chemicals including carbon black, which is known to the State of California to cause cancer or birth defects or other reproductive harm. For more information visit www.P65WARNINGS.ca.gov

Special Order Availability	
Size	Maximum Rib Width
RB48 to RB105	28
RB108 and up	26
RC - All sizes	22
RD - All sizes	15

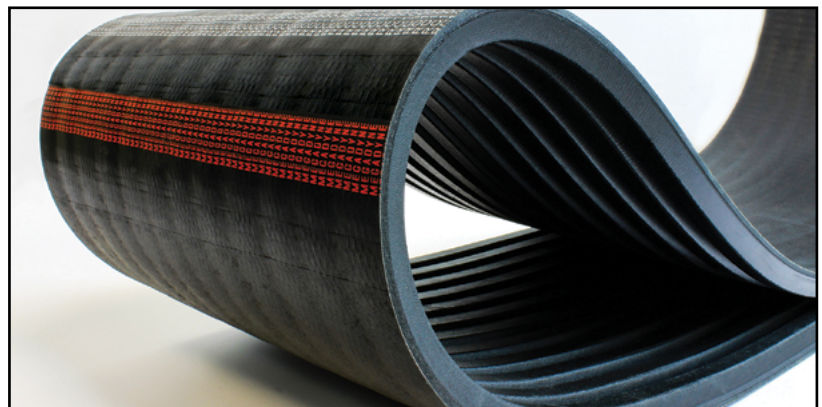

BANDED V-BELTS



UniMatch® Banded V-Belts Deep Wedge Sections R3V, R5V, R8V

Oil & Heat Resistant/Static Dissipating

UniMatch Banded V-belts are available in Deep Wedge sections 3V, 5V and 8V, and feature the same premium constructions as the individual Deep Wedge belt and are bonded together with a fabric-neoprene top band. These belts are often used on vertical shafts and where belt vibration, whipping and turn-over must be minimized.

WARNING: This product can expose you to chemicals including carbon black, which is known to the State of California to cause cancer or birth defects or other reproductive harm.
For more information visit www.P65WARNINGS.ca.gov

Banded Deep Wedge V-belts are specified by a number followed by a forward slash which indicates banded construction, number of ribs and a letter/number combination indicating the base belt part number - **Example: 8/5V750**

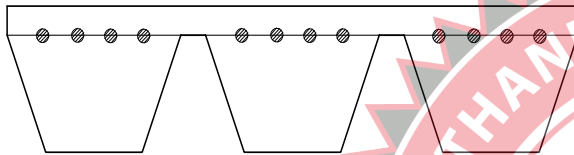

Part Nomenclature

8/5V750

- 8** = One banded belt with 8 ribs
- 5V** = Indicates belt type/cross section
- 750** = Effective length in tenths of an inch = 75.0 "

Features & Benefits

- High Power Capability** High power with a more compact drive
- Banded Construction** Fabric/Neoprene top band enhances stability and prevents belts from turning over or coming off of the drive. Minimizes vibration.
- Oil & Heat Resistant** Durability in tough environments

Construction

- Compound** NR/SBR
- Cord** Polyester
- Cover** Cotton/polyester blend
- Top Band** Fabric/Neoprene

Technical Info

- Applications** HVAC equipment where high power transmission is required. Air handlers, general HVAC equipment
- Engineering Standards** Conforms to ARPM standard IP-22
- Temperature Range** -22°F/+176°F (-20°C/+80°C)
- Recommended Pulleys** Use pulleys made to ARPM standards
- Note** 2 and 3 rib belts are not returnable

It is common practice for some belt suppliers to fill orders for banded V-belts by supplying separate bands (belts) that add up to the total number of ribs requested. Normal policy for Megadyne is to supply a one-piece banded V-belt unless otherwise requested. **Example: Order is for one belt with 8 ribs.** Some suppliers will send two belts with 4 ribs each. Megadyne will ship as ordered, one belt with 8 ribs, unless otherwise specified.

All items subject to minimum order requirements.

UniMatch® Banded Deep Wedge V-Belts R3V, R5V, R8V

AVAILABLE SIZES

Additional Lengths may be available. Contact Megadyne for sizes not listed.

R3V		
Belt Number	Effective Length (inch)	Approx. Weight (lbs.)
R3V355	35.5	0.20
R3V400	40.0	0.20
R3V425	42.5	0.20
R3V450	45.0	0.20
R3V475	47.5	0.20
R3V500	50.0	0.20
R3V530	53.0	0.20
R3V560	45.0	0.20
R3V600	60.0	0.20
R3V630	63.0	0.30
R3V670	67.0	0.30
R3V710	71.0	0.30
R3V730	73.0	0.30
R3V750	75.0	0.30
R3V800	63.0	0.30
R3V830	83.0	0.40
R3V850	85.0	0.40
R3V900	90.0	0.40
R3V950	95.0	0.40
R3V1000	100.0	0.40
R3V1060	106.0	0.50
R3V1120	112.0	0.50
R3V1180	118.0	0.50
R3V1250	125.0	0.50
R3V1320	132.0	0.60
R3V1400	140.0	0.60

R5V		
Belt Number	Effective Length (inch)	Approx. Weight (lbs.)
R5V500	50.0	0.60
R5V530	53.0	0.60
R5V560	56.0	0.70
R5V600	60.0	0.70
R5V630	63.0	0.70
R5V670	67.0	0.80
R5V710	71.0	0.80
R5V750	75.0	0.80
R5V800	80.0	0.90
R5V850	85.0	0.90
R5V900	90.0	1.00
R5V950	95.0	1.10
R5V975	97.5	1.20
R5V1000	100.0	1.20
R5V1060	106.0	1.30
R5V1120	112.0	1.30
R5V1180	118.0	1.40
R5V1250	125.0	1.50
R5V1320	132.0	1.60
R5V1400	140.0	1.70
R5V1500	150.0	1.80
R5V1600	160.0	1.90
R5V1650	165.0	2.00
R5V1700	170.0	2.00
R5V1800	180.0	2.10
R5V1900	190.0	2.20
R5V2000	200.0	2.40
R5V2120	212.0	2.50
R5V2240	224.0	2.70
R5V2360	236.0	2.80
R5V2500	250.0	3.00
R5V2650	265.0	3.20
R5V2800	280.0	3.30
R5V3000	300.0	3.60
R5V3150	315.0	3.80
R5V3350	335.0	4.00
R5V3550	355.0	4.30

R8V		
Belt Number	Effective Length (inch)	Approx. Weight (lbs.)
R8V1000	100.0	3.30
R8V1060	106.0	3.50
R8V1120	112.0	3.70
R8V1180	118.0	3.90
R8V1250	125.0	4.10
R8V1320	132.0	4.40
R8V1400	140.0	4.60
R8V1500	150.0	4.90
R8V1600	160.0	5.20
R8V1650	165.0	5.40
R8V1700	170.0	5.60
R8V1800	180.0	5.90
R8V1900	190.0	6.30
R8V2000	200.0	6.60
R8V2120	212.0	6.90
R8V2240	224.0	7.00
R8V2360	236.0	7.00
R8V2400	240.0	8.00
R8V2500	250.0	8.30
R8V2650	265.0	8.70
R8V2700	270.0	9.00
R8V2800	280.0	9.20
R8V3000	300.0	9.80
R8V3150	315.0	9.90
R8V3350	335.0	11.10
R8V3750	375.0	11.70
R8V4000	400.0	12.40
R8V4250	425.0	13.20
R8V4500	450.0	14.00
R8V4750	475.0	14.80
R8V5000	500.0	16.50
R8V5600	560.0	18.40



WARNING: This product can expose you to chemicals including carbon black, which is known to the State of California to cause cancer or birth defects or other reproductive harm. For more information visit www.P65WARNINGS.ca.gov

Special Order Availability	
Size	Maximum Rib Width
R3V425 to R3V475	21
R3V500 to R3V1060	54
R3V1120 to R3V1400	48
R5V - All sizes	30
R8V - All sizes	20

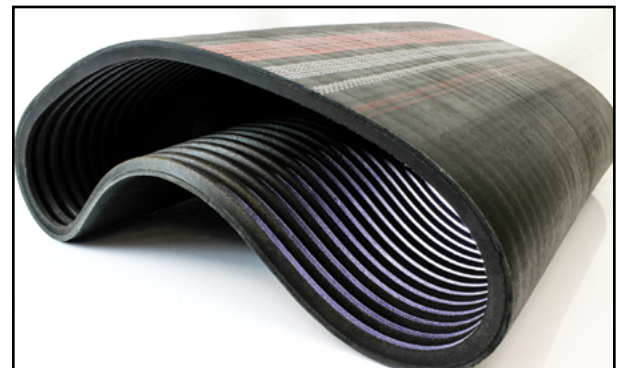

BANDED V-BELTS



UniMatch® Deep Wedge Cog Banded V-Belts R3VX, R5VX

Oil & Heat Resistant/Static Dissipating

UniMatch Banded V-belts are available in Deep Wedge Cog sections 3VX and 5VX. They feature the same premium constructions as our individual Cogged Raw Edge belts and are bonded together with a fabric-neoprene top band. These belts are often used on vertical shafts and where belt vibration, whipping and turn-over must be minimized.

Banded Deep Wedge Cog V-belts are specified by a number followed by a forward slash which indicates banded construction, number of ribs and a letter/number combination indicating the base belt part number. **Example: 3/3VX335**



WARNING: This product can expose you to chemicals including carbon black, which is known to the State of California to cause cancer or birth defects or other reproductive harm. For more information visit www.P65WARNINGS.ca.gov

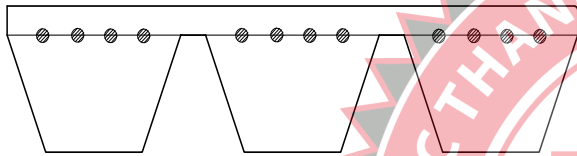

Part Nomenclature

3/3VX335

- 3** = One banded belt with 3 ribs
- 3V** = Belt type/cross section
- X** = Raw edge + cog construction
- 335** = Effective length in tenths of an inch = 33.5"

Features & Benefits

- High Power Capability** High power with a more compact drive
- Raw Edge Sidewalls** Increased friction reduces slippage/increases efficiency versus wrapped V-belts. Saves energy.
- Banded Construction** Fabric/Neoprene top band enhances stability and prevents belts from turning over or coming off of the drive. Minimizes vibration.
- Oil & Heat Resistant** Durability in tough environments

Construction

Compound	Chloroprene
Cord	Polyester
Sidewalls	Raw Edge
Top Band	Fabric/Neoprene

Technical Info

- Applications** HVAC equipment where high power transmission and limited slippage is necessary. Air handlers, general HVAC equipment
- Engineering Standards** Conforms to ARPM standard IP-22
- Temperature Range** -22°F/+194°F (-30°C/+90°C)
- Recommended Pulleys** Use pulleys made to ARPM standards
- Note** 2 and 3 rib belts are not returnable

It is common practice for some belt suppliers to fill orders for banded V-belts by supplying separate bands (belts) that add up to the total number of ribs requested. Normal policy for Megadyne is to supply a one-piece banded V-belt unless otherwise requested. **Example: Order is for one belt with 8 ribs.** Some suppliers will send two belts with 4 ribs each. Megadyne will ship as ordered, one belt with 8 ribs.

All items subject to minimum order requirements.

UniMatch® Deep Wedge Cog Banded V-Belts - R3VX, R5VX

AVAILABLE SIZES

Additional lengths may be available. Contact Megadyne for sizes not listed.

R3VX			
Belt Number	Effective Length (inch)	Approx. Weight (lbs.)	Max. No of Ribs
R3VX315	31.5	0.15	70
R3VX335	33.5	0.16	70
R3VX355	35.5	0.17	70
R3VX375	37.5	0.18	70
R3VX400	40.0	0.19	70
R3VX425	42.5	0.21	70
R3VX430	43.0	0.21	70
R3VX450	45.0	0.22	70
R3VX460	46.0	0.22	70
R3VX475	47.5	0.23	70
R3VX500	50.0	0.24	70
R3VX520	52.0	0.25	70
R3VX530	53.0	0.26	70
R3VX560	56.0	0.27	70
R3VX600	60.0	0.29	70
R3VX630	63.0	0.31	70
R3VX670	67.0	0.33	70
R3VX710	71.0	0.34	70
R3VX750	75.0	0.36	70
R3VX800	80.0	0.39	70
R3VX850	85.0	0.41	70
R3VX900	90.0	0.44	70
R3VX925	92.5	0.45	70
R3VX950	95.0	0.46	70
R3VX1000	100	0.49	70
R3VX1060	106.0	0.51	5
R3VX1120	112.0	0.54	5
R3VX1180	118.0	0.57	5
R3VX1250	125.0	0.61	5
R3VX1320	132.0	0.64	5
R3VX1400	140.0	0.67	5

R5VX			
Belt Number	Effective Length (inch)	Approx. Weight (lbs.)	Max. No of Ribs
R5VX500	50.0	0.65	43
R5VX530	53.0	0.69	43
R5VX560	56.0	0.73	43
R5VX600	60.0	0.79	43
R5VX630	63.0	0.83	43
R5VX670	67.0	0.88	43
R5VX710	71.0	0.93	43
R5VX750	75.0	0.98	43
R5VX800	80.0	1.05	43
R5VX830	83.0	1.09	43
R5VX850	85.0	1.11	43
R5VX900	90.0	1.18	43
R5VX950	95.0	1.24	43
R5VX1000	100.0	1.31	43
R5VX1060	106.0	1.39	5
R5VX1120	112.0	1.47	5
R5VX1180	118.0	1.55	5
R5VX1250	125.0	1.64	5
R5VX1320	132.0	1.73	5
R5VX1400	140.0	1.83	5
R5VX1500	150.0	1.96	5
R5VX1600	160.0	2.10	5
R5VX1700	170.0	2.23	5
R5VX1800	180.0	2.36	5
R5VX1900	190.0	2.49	5
R5VX2000	200.0	2.62	5

 **WARNING:** This product can expose you to chemicals including carbon black, which is known to the State of California to cause cancer or birth defects or other reproductive harm. For more information visit www.P65WARNINGS.ca.gov

All items subject to minimum order requirements.

SYNCHRONOUS BELTS

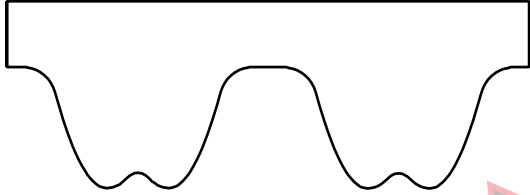

Platinum

Ultra High Torque 8M, 14M RPC Parabolic Tooth Profile

Platinum is an Ultra-High Performance, rubber-based belt. "Dual Core" Hybrid Tensile Cord Technology, combined with a nitrile-based HNBR compound body, results in a product capable of handling the most demanding drives replacing roller chains, gears and Poly Chain®. The "RPC" belt tooth profile is an evolution of the industry standard RPP®. It is fully interchangeable with HTD®, RPP and Poly Chain pulley tooth profiles. The RPC belt tooth profile allows upgrade of existing drive systems (RPP, HTD, Poly Chain and PowerGrip® GT® 2) without replacing the existing pulleys. Platinum is a true "drop-in" replacement on all commonly used deep tooth pulley profiles.

PLATINUM synchronous belts are specified by pitch length, tooth pitch and width in millimeters - **Example: 3500PLT14M65**



WARNING: This product can expose you to chemicals including carbon black, which is known to the State of California to cause cancer or birth defects or other reproductive harm. For more information visit www.P65WARNINGS.ca.gov

PART NOMENCLATURE	
3500PLT14M65	
3500	= Pitch length (3500mm)
PLT	= Platinum belt construction
14M	= Tooth Pitch (14 mm)
65	= Belt width (65 mm)

Pitch Code	Tooth Pitch (mm)	Standard Widths/Width Codes (mm)								Pitch Lengths (mm)	
		12	20	21	36	37	62	68	90		125
PLT8	8	12	-	21	36	-	62	-	-	-	248 thru 4400
PLT14	14	-	20	-	-	37	-	68	90	125	994 thru 4956

Standard widths shown. Can be cut to any width desired.

Features & Benefits

RPC Tooth Profile	Compatible with Poly Chain, RPP, HTD and PowerGrip GT 2 pulleys
Highest Power Capacity	Reduced belt/pulley width means less noise and drive weight, bearing load and cost, with increased efficiency and energy savings
Dual Core Hybrid Tensile Cord	Guarantees high power capability and maintenance-free operation
Greater Length Range	More available lengths than any competitor
Lower Noise	RPC low noise tooth profile combined with HNBR rubber is quieter than polyurethane belt
High Temperature Capability	Up to 239°F versus 185°F for polyurethane
HNBR Rubber Construction	Better flexibility than polyurethane belts. Important for long life and drives with idlers

Construction

Compound	HNBR with high resistance to petroleum oils and solvents
Tensile Cord	Dual Core Hybrid tensile cord allows the highest power transmission capability
Tooth Cover	Specially treated nylon fabric to reduce friction and pulley wear
Tooth Profile	RPC Parabolic - full interchange with HTD, RPP and Poly Chain pulleys

Technical Info

Applications	Drives requiring maximum efficiency, synchronous operation and the highest power capacity. Air handlers, extraction fans, ventilation fans, cooling towers, general HVAC equipment
Engineering Standards	Conforms to ARPM IP-27 and ISO 13050 standard tolerances
Temperature Range	-31°F/+239°F (-35°C/+115°C)
Recommended Pulleys	Use pulleys made to ARPM or ISO 13050 standards
Special Widths	Can be supplied in any width - available upon request
Silicone-Free Packaging	Also available individually packaged - non-stock, made to order

All items subject to minimum order requirements.

Platinum

Ultra High Torque 8M, 14M RPC Parabolic Tooth Profile

AVAILABLE SIZES

Additional lengths may be available.
Contact Megadyne for sizes not listed.

Platinum 8M		
Belt Type	Pitch Length (mm)	Number of Teeth
248PLT8	248	31
288PLT8	288	36
320PLT8	320	40
352PLT8	352	44
360PLT8	360	45
384PLT8	348	48
408PLT8	408	51
416PLT8	416	52
456PLT8	456	57
480PLT8	480	60
536PLT8	536	67
544PLT8	544	68
560PLT8	560	70
600PLT8	600	75
608PLT8	608	76
632PLT8	632	79
640PLT8	640	80
680PLT8	680	85
720PLT8	720	90
800PLT8	800	100
840PLT8	840	105
880PLT8	880	110
896PLT8	896	112
920PLT8	920	115
960PLT8	960	120
1000PLT8	1000	125

Platinum 8M		
Belt Type	Pitch Length (mm)	Number of Teeth
1040PLT8	1040	130
1080PLT8	1080	135
1120PLT8	1120	140
1160PLT8	1160	145
1200PLT8	1200	150
1224PLT8	1224	153
1280PLT8	1280	160
1440PLT8	1440	180
1464PLT8	1464	183
1600PLT8	1600	200
1760PLT8	1760	220
1792PLT8	1792	224
1800PLT8	1800	225
2000PLT8	2000	250
2200PLT8	2200	275
2240PLT8	2240	280
2400PLT8	2400	300
2520PLT8	2520	315
2600PLT8	2600	325
2800PLT8	2800	350
2840PLT8	2840	355
3048PLT8	3048	381
3200PLT8	3200	400
3280PLT8	3280	410
3600PLT8	3600	450
4000PLT8	4000	500
4400PLT8	4400	550

Platinum 14M		
Belt Type	Pitch Length (mm)	Number of Teeth
994PLT14	994	71
1092PLT14	1092	78
1120PLT14	1120	80
1190PLT14	1190	85
1260PLT14	1260	90
1288PLT14	1288	92
1344PLT14	1344	96
1400PLT14	1400	100
1512PLT14	1512	108
1568PLT14	1568	112
1610PLT14	1610	115
1750PLT14	1750	125
1778PLT14	1778	127
1890PLT14	1890	135
1960PLT14	1960	140
2100PLT14	2100	150
2240PLT14	2240	160
2310PLT14	2310	165
2380PLT14	2380	170
2450PLT14	2450	175
2520PLT14	2520	180
2590PLT14	2590	185
2660PLT14	2660	190
2800PLT14	2800	200
3136PLT14	3136	224
3150PLT14	3150	225
3304PLT14	3304	236
3360PLT14	3360	240
3500PLT14	3500	250
3850PLT14	3850	275
3920PLT14	3920	280
4326PLT14	4326	309
4410PLT14	4410	315
4956PLT14	4956	354



WARNING: This product can expose you to chemicals including carbon black, which is known to the State of California to cause cancer or birth defects or other reproductive harm. For more information visit www.P65WARNINGS.ca.gov



Pulleys & Bushings

Megadyne offers a comprehensive line of pulleys and bushings for V-belts and synchronous/timing applications. Contact us for complete product information.

Light Duty Pulleys - Light duty cast iron pulleys are machined from gray cast iron. They are statically balanced, painted and are individually packaged. Available in single and double groove. Bushings are ordered separately.

- AK Pulleys fit 3L, 4L and A section
- BK Pulleys fit 4L, A, 5L and B section

Variable Pitch Pulleys - Available in single (1VP) and double (2VP) groove. Includes hollow head set screws and keyseat. Jason standard pulleys can be used as a companion pulley. Available in various bore sizes. Fits 3L, 4L, 5L, A or B belt sections.

AL (Blower) Pulleys - AL Pulleys for Light Duty Applications. Cast Aluminum construction. Includes set screw and keyseat. Not to be used with drives rated for "AX" belt (cogged raw edge).

QD Pulleys and Bushings - QD pulleys and bushings are available for heavy duty applications. They are statically balanced and painted, and are individually packaged, sealed in plastic wrap.

- A/B Combination up to 6 grooves
- C section up to 8 grooves
- D section up to 10 grooves
- 3V section up to 10 grooves
- 5V section up to 6 grooves

Synchronous/Timing Pulleys/Clamping Plates - Megadyne supplies complete drives, including metric pulleys and clamping belt plates made to standard and custom specifications. Available in aluminum or steel, our pulleys are manufactured to precise tolerances to assure a perfect fit between belt and pulley. Timing pulleys are balanced, painted and available in all standard pitches for quick delivery. Contact us for more information.

Non-Stock/Made-To-Order - If you do not find the pulley you need in this catalog, please contact us. We can supply quotations on virtually any non-stock or made-to-order pulley with special features or construction. We are often able to supply the product with minimal delays on a special order basis.



WARNING: This product can expose you to chemicals including lead, which is known to the State of California to cause cancer or birth defects or other reproductive harm. For more information visit www.P65WARNINGS.ca.gov

All items subject to minimum order requirements.

Light & Heavy Duty Pulleys & Bushings

- Individually Bagged/Packaged for Protection
- Individually Bar-Coded

Not all items are in stock at all locations.
Please contact Megadyne for complete product information.

Light Duty Pulleys & Bushings

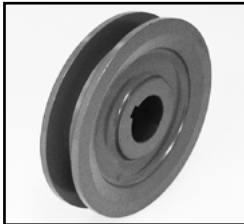

- AK - Bored to Size** - .75" through 15.75" diameter
- BK - Bored to Size** - 1/2" through 1-7/16" diameter

WARNING: This product can expose you to chemicals including lead, which is known to the State of California to cause cancer or birth defects or other reproductive harm. For more information visit www.P65WARNINGS.ca.gov

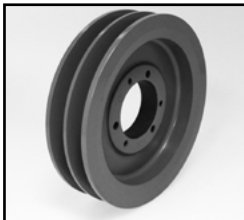

- AK - Bushed** - Pulley 3" through 18.75" diameter
- BK - Bushed** - "H" Bushed Sheave reduces inventory & increases selection
- H - Bushings** - 5/8" through 1-3/8" bore range

WARNING: This product can expose you to chemicals including lead, which is known to the State of California to cause cancer or birth defects or other reproductive harm. For more information visit www.P65WARNINGS.ca.gov

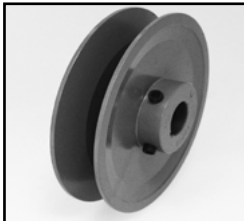

- Variable Pitch Pulleys**
 - 1VP and 2VP Variable Pitch
 - Fits 3L, 4L/A, 5L/B, A, B or 5V Belts
 - 2-1/2" through 7-1/2" diameter
 - 1/2" through 1-5/8" bore

WARNING: This product can expose you to chemicals including lead, which is known to the State of California to cause cancer or birth defects or other reproductive harm. For more information visit www.P65WARNINGS.ca.gov

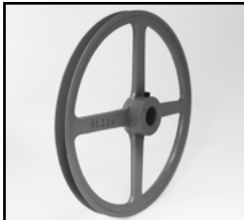

- AL (Blower) Pulleys**
 - Bored to size with 5/8" through 1" diameter
 - 5" through 12" diameter pulley

WARNING: This product can expose you to chemicals including lead, which is known to the State of California to cause cancer or birth defects or other reproductive harm. For more information visit www.P65WARNINGS.ca.gov

Heavy Duty Pulleys & Bushings



- QD Pulleys & Bushings**
 - 3.57" through 58" diameter
 - Single through 8 groove pulleys
 - JA, H, SH, SDS, SD, SK, SF, E, F, J, M, N, P Bushings
 - 5/8" through 6" bore

WARNING: This product can expose you to chemicals including lead, which is known to the State of California to cause cancer or birth defects or other reproductive harm. For more information visit www.P65WARNINGS.ca.gov

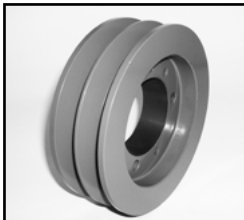

- TB Pulleys & Bushings**
 - Pulley used with double split taper bushings
 - 3.75" through 12.75" diameter
 - P1 & Q1 Bushings from 5/8" through 1-15/16"

WARNING: This product can expose you to chemicals including lead, which is known to the State of California to cause cancer or birth defects or other reproductive harm. For more information visit www.P65WARNINGS.ca.gov

DRIVE BELT NOMENCLATURE - V-BELTS

LIGHT DUTY

Fractional HP (FHP) - Suitable for light duty applications normally using fractional horsepower motors

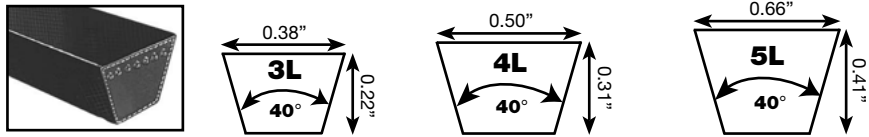

CLASSICAL HEAVY DUTY

Multi-Plus® - UniMatch®
Wide range of sizes

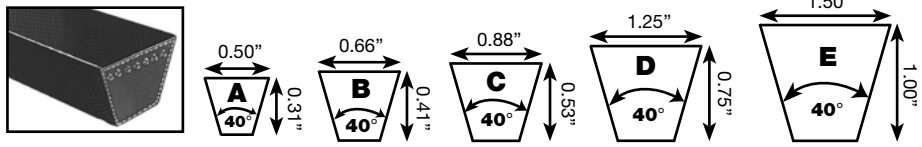

MOLDED COGGED

Cogs allow use of smaller diameter pulleys and provide heat dissipation. Raw Edge Sidewalls (no fabric cover) prevent slippage.

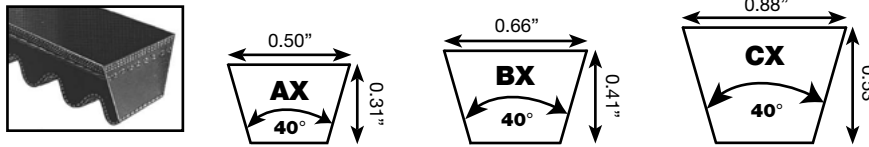

WEDGE

Narrower, deeper profile with higher power capability than classical v-belt. Allows for smaller, more compact drives.

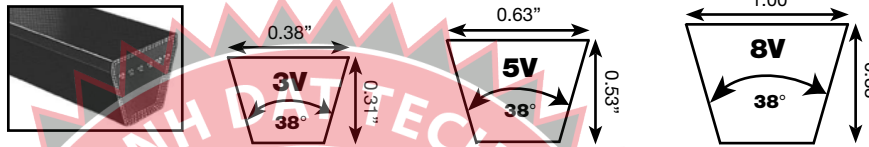

WEDGE COGGED

Same properties of Wedge. Cogged for greater flexibility and heat dissipation. Raw Edge Sidewalls (no fabric cover) prevent slippage.

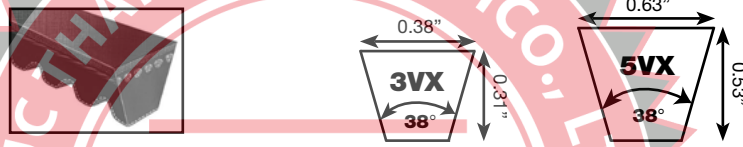

V-Belt Type	Identified By	Part Number Example	Approximate Outside Length
Fractional HP (FHP)	Effective Length	4L500 =	50"
Classical Multi-Plus	Standard Length Designation	A48 =	
Fractional HP	Effective Length	5L500 =	
Classical Multi-Plus	Standard Length Designation	B47 =	
Classical Cogged	Standard Length Designation	AX48 =	
Narrow Deep Wedge/Cogged	Effective Length	5V500/5VX500 =	

NOTE: Length information values in the above table are approximate. Industry standards require that to accurately measure a belt, it must be installed on a fixture with two pulleys of prescribed dimension and tensioned to a specific value. Accurate values cannot be measured by hand on a free length of belt.

WRAPPED V-BELT

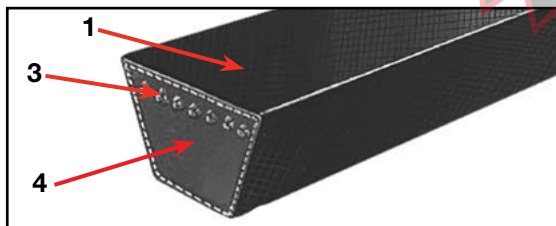

RAW EDGE V-BELT

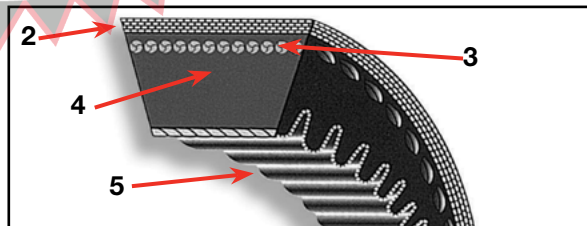

BELT CONSTRUCTION

- Rubberized Fabric Cover** - Cover envelops entire belt and protects the belt core.
- Top Fabric** - Provides heat & oil resistance.
- Load Carrying Section** - Cords/Tensile Members give ability to transmit power and ensure uniform load distribution.
- Compression Section** - Elastomer resists compression fatigue and dissipates internal heat build-up. Provides firm lateral pressure against sheave/pulley sidewall and distributes the load to the cords.
- Precision Molded Cogs** - Provides additional flexibility, allows for use of smaller pulley diameters, aids in heat dissipation.

Note: All belt size dimensions in this publication are nominal.

SYNCHRONOUS BELTS

The terms synchronous belt and timing belt are used interchangeably in the power transmission industry. Technically speaking, "timing belt" refers to the trapezoidal tooth standard timing belt. Standard timing belts represent the original, older tooth profile technology. Newer, improved tooth profiles (curvilinear and parabolic) combined with superior upgraded tensile members (cord) and compounds exceed the performance of standard timing belt allowing much higher horsepower and torque to be transmitted, often in a smaller, more compact, overall drive space. The drive space can be more compact with curvilinear and parabolic belts because their higher horsepower capabilities allow the use of a narrower belt width.

Megadyne Synchronous Belts							
Belt Type	Power Rating	Tooth Profile	Pitch Codes/Tooth Pitch (mm)				Anti-Static Properties
RPP®	high torque	parabolic	3M	5M	8M	14M	---
RPP® Silver2	extra high torque	parabolic	---	---	8MS	14MS	*yes
RPP® Gold	super high torque	parabolic	---	**5MG	8MG	14MG	*yes
RPC Platinum	ultra high torque	parabolic	---	---	PLT8	PLT14	---

* Conforms to ISO 9563 standard for anti-static properties
 ** RPP Gold in 5 mm pitch (5MG) is available upon request
 All dimensions of Metric Synchronous belts are expressed in millimeters (pitch length, tooth pitch, width)

Synchronous belts are identified by tooth profile (the shape of the tooth) and tooth pitch. Tooth pitch (P) is the distance between two adjacent belt teeth.

Pitch Code	Tooth Pitch
	"P" (mm)
3M	3
5M	5
8M	8
14M	14

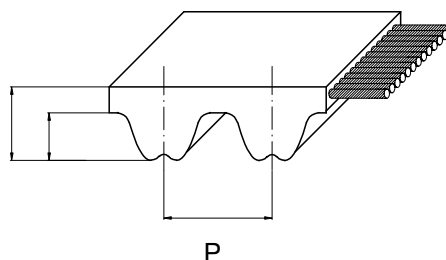

Note: All belt size dimensions in this publication are nominal.

Synchronous Belt - Tooth Profile Dimensions

RPP (parabolic)					
Belt Dimensions (mm)		RPP3	RPP5	RPP8	RPP14
Pitch	P	3	5	8	14
Tooth Height	ht	1.15	2.00	3.20	6.00
Belt Height	H	2.40	3.80	5.40	9.70

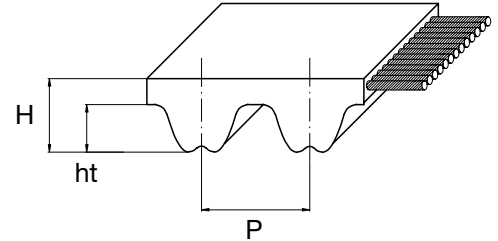

RPP Silver 2 (parabolic)				
Belt Dimensions (mm)		Silver 5M	Silver2 8M	Silver2 14M
Pitch	P	5	8	14
Tooth Height	ht	2.00	3.20	6.00
Belt Height	H	3.80	5.40	9.70

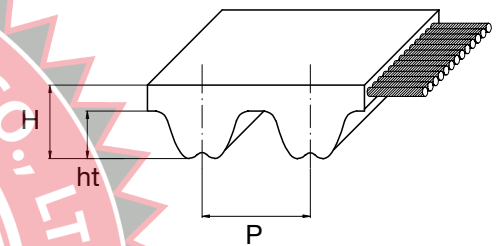

RPP Gold (parabolic)				
Belt Dimensions (mm)		Gold 5M	Gold 8M	Gold 14M
Pitch	P	5	8	14
Tooth Height	ht	2.00	3.20	6.00
Belt Height	H	3.80	5.40	9.70

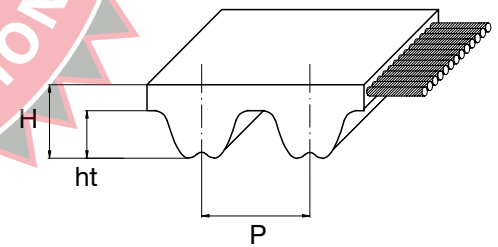

RPC Platinum (parabolic)			
Belt Dimensions (mm)		Platinum 8M	Platinum 14M
Pitch	P	8	14
Tooth Height	ht	3.46	6.10
Belt Height	H	5.40	9.70

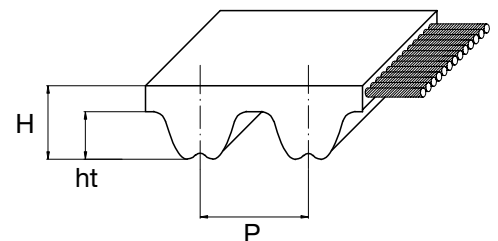

V-Belt Failure Analysis

Exposure to Oil & Grease

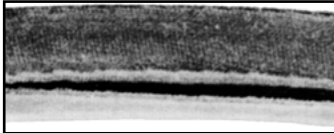

Cause: Belt swelling, exterior softness and bottom envelope seam to open/split.

Remedy: Splash Guards, don't over-lubricate, clean belts/sheaves.

Weathering or "Crazing"

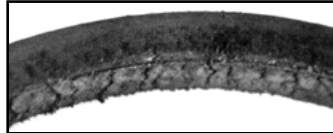

Cause: Belt drive elements, as well as aggravation by small sheaves.

Remedy: Check tension, provide drive protection and replace belt(s).

Cut Bottom & Sidewall

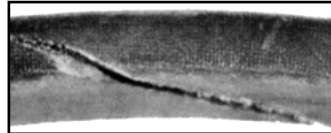

Cause: Belt being pried over sheave during installation, as cut above indicates.

Remedy: Use proper length belts and tension properly when installing.

Severe Localized Wear

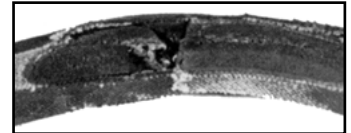

Cause: Spin burn caused by a frozen or locked drive sheave not able to turn freely.

Remedy: Determine that drive components turn freely and, if necessary, tighten belt.

Rough Sheave Sidewalls

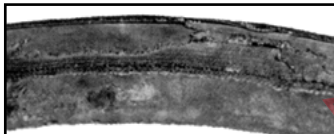

Cause: Constant slippage due to belt being misaligned on worn sheaves.

Remedy: Use correct belt size. Align or replace sheaves.

Broken Belt



Cause: Rough sheaves and dust build-up cause belt failure and severe envelope wear.

Remedy: Shield the drive.

Snub Break

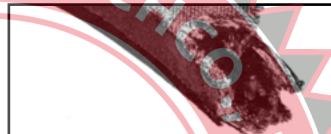

Cause: Cover wear indicates slippage and clean break reveals sudden snap due to non-proper drive tensioning.

Remedy: Maintain proper drive tension.

Abrasion

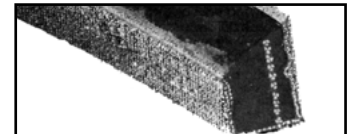

Cause: Sidewall wear a result of foreign material and rust in sheaves. Belt dropped to bottom of sheave groove.

Remedy: Use Dust guards to prevent abrasion.

Worn Side Pattern

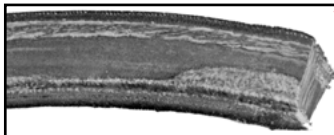

Cause: Worn or misaligned sheaves.

Remedy: Retension drive to stop slipping, realign sheaves (replace if needed), replace belt if incorrect size.

Oil Deterioration

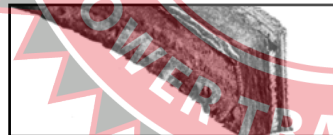

Cause: Rubber softened by excessive oil exposure, causing deterioration.

Remedy: Use splash guards to protect drive against oil contamination.

Cover Fabric Rupture



Cause: Fabric cover ruptured during installation due to belt being pried over belt sheave.

Remedy: Verify proper installation of belts.

Base Cracking

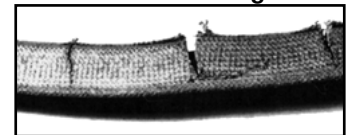

Cause: Insufficient tension. Slippage causes heat build-up and belt degradation.

Remedy: Install new belt with proper installation tension.

Distorted Belt

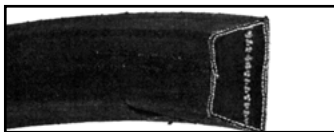

Cause: Distortion caused by broken cords or adhesion breakdown.

Remedy: Avoid prying on belts. Check sheaves for recommended diameters.

Ply Separation

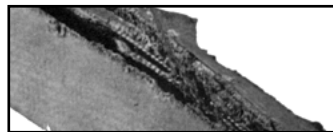

Cause: Split along pitch line indicating belt ran on too small diameter of sheave.

Remedy: Install a cogged type belt.

Ruptured Belt



Cause: Ruptured cords in the plies, caused by high shock load on foreign object between belt and sheave groove.

Remedy: Check tension and shield the drive from external debris

Slip Burn



Cause: Belt slips under load.

Remedy: Replace belt and tighten drives until slipping stops.

PULLEY INSPECTION

To assure maximum service from a drive, use the Megadyne Sheave Gauge (fig. 1) to inspect sheaves every time a belt is replaced.

- Inspect for burrs or rough spots along the sheave rim.
- Check to make sure side walls are not dished out (Fig. 2). On multiple belt drives, it is essential that all grooves have no wear. Wear on one groove alone will create “differential driving” and is equivalent to running a mis-atthed set of belts.
- Check for shiny grooves in pulley. Shiny grooves indicate a worn spot that will wear replacement belt.
- Check the alignment of pulleys and that the shafts are parallel.
- Failure to replace worn sheaves results in poor performance, low efficiency and premature failure of the drive belt.

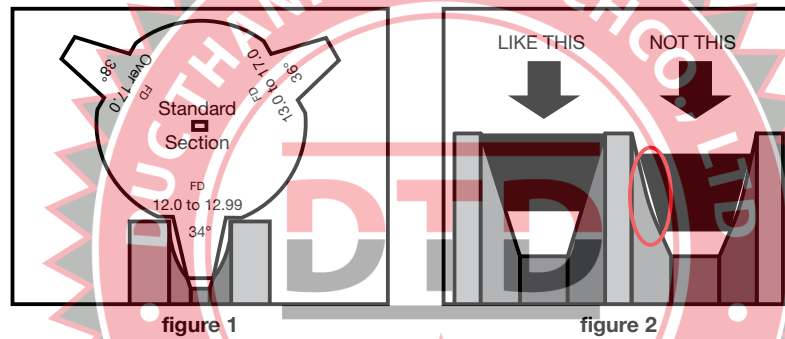

Sheave Gauge

Can be used to determine both Sheave and Belt size.
Check for sheave wear to determine when a replacement is necessary.

PART NUMBER: G001



All items subject to minimum order requirements.

V-BELT TENSIONING

SIMPLIFIED TENSIONING PROCEDURE

V-belt tensioning adjustment can be made using a tension gauge or other type spring scale, using the following procedure.

After seating the belts in the groove and adjusting center distance so as to take up slack in the belts, further increase the tension until only a slight bow on the slack side is apparent while the drive is operating under load.

Stop the drive and, using the gauge, measure the force necessary to depress one of the center belts 1/64-inch for every inch of belt span (see sketch below).

For example, a deflection for a 50-inch belt span is 50/64ths, or 25/32-inch. The amount of force required to deflect the belt should compare with the deflection forces noted in the Standard V-Belt Tensioning Table. Also notice for V-belts the deflection forces vary from the initial "run-in" values, which are greater (reflecting higher run-in tensioning) to the "normal" values for after the run-in period.

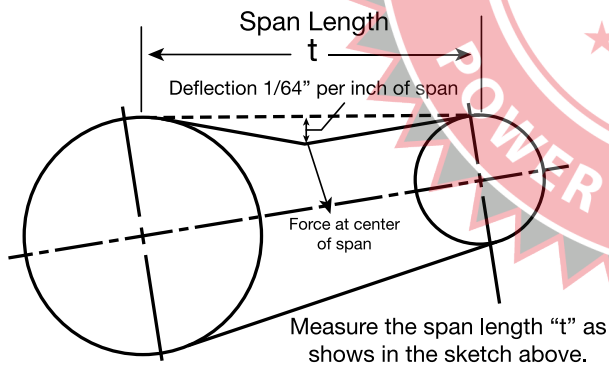

Simplified Tensioning Procedure V-Belt Deflection Force Table						
Belt Cross Section	Smaller Pulley Diameter Range (inch)		Deflection Force		Weight kg/m	
			Run-In	Normal		
			(lbs.)	(lbs.)	Single	Banded weight per rib
A	3.0	3.6	3.375	2.25	0.13	---
	3.8	4.8	4.25	2.875		
	5.0	7.0	5.125	3.375		
AX	3.0	3.6	4.125	2.75	0.12	---
	3.8	4.8	5	3.25		
	5.0	7.0	6	4		
B	3.4	4.2	4	2.625	0.19	0.27
	4.4	5.2	6	4		
	5.4	9.4	7.125	5.25		
BX	3.4	4.2	5.25	3.5	0.19	---
	4.4	5.2	7.125	4.75		
	5.4	9.4	9	6		
C	7.0	9.0	11.25	7.5	0.33	0.42
	9.5	16.0	15.75	10.5		
CX	7.0	9.0	13.5	9	0.31	---
	9.5	16.0	17.5	11.75		
D	12.0	16.0	24.5	16.5	0.64	---
	18.0	22.0	33	22		
E	21.6	27.0	48	32	0.98	---
	3.40	4.20	6	4		
3V	4.20	10.6	7	5	0.08	0.12
	2.20	3.65	7	5		
3VX	4.12	10.6	8	6	0.070	0.09
	7.10	10.9	16	10		
5V	11.8	16.0	20	12.5	0.20	0.30
	4.40	10.9	18	12		
5VX	11.8	16.0	22	15	0.18	0.23
	12.5	17.0	36	22.5		
8V	18.0	22.4	40	25	0.59	0.70

Note:

For drives with shock loading or other unusual conditions, the tension may have to be increased for proper operation of the drive. If the belt slips, tighten the belt. Utilization of this simplified tension procedure may not result in optimum belt life due to the static tension being less accurate than static tension calculated based on the horsepower. When greater accuracy is required on critical drives refer to Megadyne technical manual or contact Application Engineering.

TROUBLESHOOTING V-BELT DRIVES

PROBLEM		Cut through on top (banded belts)	Incorrect length installed (too short)	Incorrect length installed (too long)	Excessive vibration	Broken belts	Loose cover & swell	Hardening & premature cracking	Belt squeal	Belt slippage	Belts turned over in sheave groove	Cover wear	Rapid belt wear
POSSIBLE CAUSE	Improper v-belt installation	✓			✓	✓	✓	✓	✓	✓	✓	✓	✓
	Sheave misalignment				✓							✓	✓
	worn or damaged sheave grooves	✓			✓			✓	✓	✓	✓	✓	✓
	Wrong belt cross section or type	✓	✓	✓	✓			✓	✓	✓	✓	✓	✓
	Incorrect belt length		✓	✓				✓	✓	✓		✓	✓
	Insufficient take-up		✓	✓				✓	✓	✓		✓	✓
	Sheave diameter too small					✓		✓	✓	✓		✓	✓
	Rubbing belt guard	✓										✓	✓
	Overloaded drive					✓		✓	✓	✓		✓	✓
	Belts improperly stored					✓		✓					✓
	Replacing one belt vs all belts					✓		✓	✓	✓		✓	✓
	Broken cords					✓		✓	✓	✓	✓	✓	✓
	Impulse and/or shock loads					✓		✓	✓	✓		✓	✓
	Lack of tension							✓	✓	✓	✓	✓	✓
	Oily drive conditions								✓	✓			
	Insufficient arc of contact							✓	✓	✓		✓	✓
	Excessive heat							✓	✓	✓		✓	✓
	Dirty environment								✓	✓		✓	✓
	Foreign material	✓				✓						✓	✓
	Uneven tension distribution of multiple v-belts					✓		✓	✓	✓		✓	✓
	Improper drive design					✓	✓	✓	✓	✓		✓	✓
	Excessive tension	✓				✓							✓
CORRECTIVE ACTION	Check guard clearance	✓										✓	✓
	Correct sheave alignment				✓							✓	✓
	Check, replace sheaves	✓			✓			✓	✓	✓	✓	✓	✓
	Check dimensions, install proper length		✓	✓	✓			✓	✓	✓	✓	✓	✓
	Re-design drive		✓	✓	✓	✓		✓	✓	✓		✓	✓
	Use larger diameter drive					✓		✓	✓	✓		✓	✓
	Replace belts (do not pry onto sheave)				✓	✓		✓	✓	✓	✓	✓	✓
	Reduce load					✓			✓	✓		✓	✓
	Replace complete set with same brand				✓	✓		✓	✓	✓		✓	✓
	Replace complete set with new v-belts				✓	✓		✓	✓	✓		✓	✓
	Increase tension							✓	✓	✓	✓	✓	✓
	Use banded v-belts				✓						✓	✓	✓
	Lubricate properly						✓						
	Clean sheaves and belt						✓			✓			
	Increase arc of contact on motor sheave							✓	✓	✓		✓	✓
	Provide ventilation							✓	✓	✓		✓	✓
	Heavier belt may be required					✓		✓	✓	✓		✓	✓
	Provide protection (use belt guard)	✓				✓						✓	✓
	Install motor soft start					✓		✓	✓	✓		✓	✓
	Reduce tension	✓				✓							✓
	Store properly					✓		✓					✓

PROBLEM	Excessive drive noise	Excessive wear - pulley teeth	Belt over-riding flanges	Apparent belt elongation	Softening of belt surface	Cracks - top surface of the belt	Tensile member rupture	Laceration of the belt	Failure through traction or laceration of teeth	Abnormal wear - on belt side	Abnormal wear - at tooth root	Abnormal wear - tooth bottom	Abnormal wear - tooth side
POSSIBLE CAUSE	Belt excessively taut												✓
	Excessive Overloading	✓	✓					✓					✓
	Incorrect pullet diameter									✓	✓	✓	✓
	Oscillation of axes and/or bearing									✓			
	Flanges Bent									✓			
	Small pulley diameter below minimum								✓				
	Excessive moisture								✓				
	Driver pulley - less than six teeth in mesh							✓	✓				
	Sub-minimum pulley dimensions	✓						✓					
	Exposure - excessively low temperature						✓						
	Exposure to oil/high temperature					✓							
	Reduction of center distance - bearings not fixed				✓								
	Faulty installation or bent flange				✓								
	Belt excessively taut		✓										
	Pulley material insufficiently hard		✓										
	Pulleys misaligned	✓											
Excessive installation tension	✓												
CORRECTIVE ACTION	Reduce center distance	✓	✓										✓
	Use a wider belt		✓				✓						✓
	Replace pulley after checking diameter									✓	✓	✓	✓
	Correct pulley position + reinforce bearing									✓			
	Straighten flanges									✓			
	Increase diameter of the pulley								✓				
	Eliminate moisture								✓				
	Driver pulley - increase teeth in mesh to at least 6							✓					
	Increase pulley diameters	✓						✓					
	Eliminate low temperature environment						✓						
	Eliminate high temperature and oil					✓							
	Correct center distance - strengthen bearing axes				✓								
	Correct, replace or repair flangs												
	Harden pulley surface or use harder material	✓											
Align pulleys properly	✓												

BELT ACCESSORIES



V-Belt Display

Display up to 184 belts at once. 46 hooks hold up to four belts each. Display height is 30", width 42", 25" deep. Includes header sign and bracket accessories for easy set-up.

PART NUMBER:
WFD-42

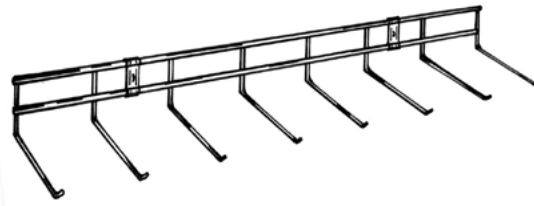

V-Belt Wall Rack

36" long mounting rack with eight 8" hooks provided. Includes two brackets for quick, easy, durable mounting.

PART NUMBER: WHD-7



Sheave Gauge

Can be used to determine both Sheave and Belt size. Check for sheave wear to determine when a replacement is necessary.

PART NUMBER: G001



110" Belt Measurer

Measures all size industrial v-belts up to 110" in ranges of 3/8", 1/2" and 5/8" accurately and efficiently.

PART NUMBER: 32-9108



WARNING: This product can expose you to chemicals including lead, which is known to the State of California to cause cancer or birth defects or other reproductive harm. For more information visit www.P65WARNINGS.ca.gov

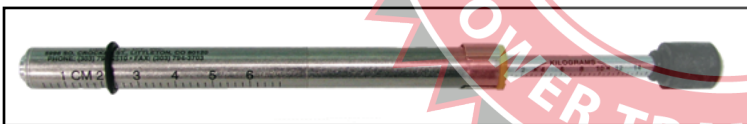

Tension Tester Gauge

Assures proper belt tension and installation.

PART NUMBER: TESTER



WARNING: This product can expose you to chemicals including lead, which is known to the State of California to cause cancer or birth defects or other reproductive harm. For more information visit www.P65WARNINGS.ca.gov



DTM-MICRO Tension Meter

- Tensioning by means of measuring frequency is considered the optimum method to achieve precision belt tension. Measurement is obtained by striking the top belt strand of a tensioned belt drive (like plucking the string of a guitar). The drive is then either tightened or loosened to arrive at a calculated frequency that corresponds to the correct tension
- The DTM-MICRO from Megadyne is a compact, precise and affordable measurement tool that allows the user to set accurate drive tension every time.

PART NUMBER: DTM-MICRO

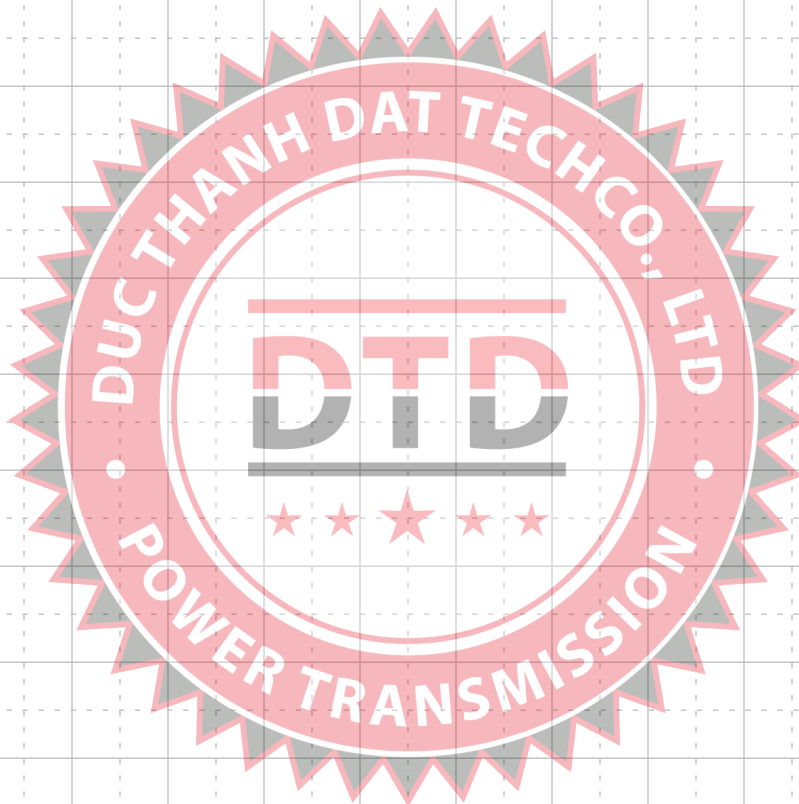

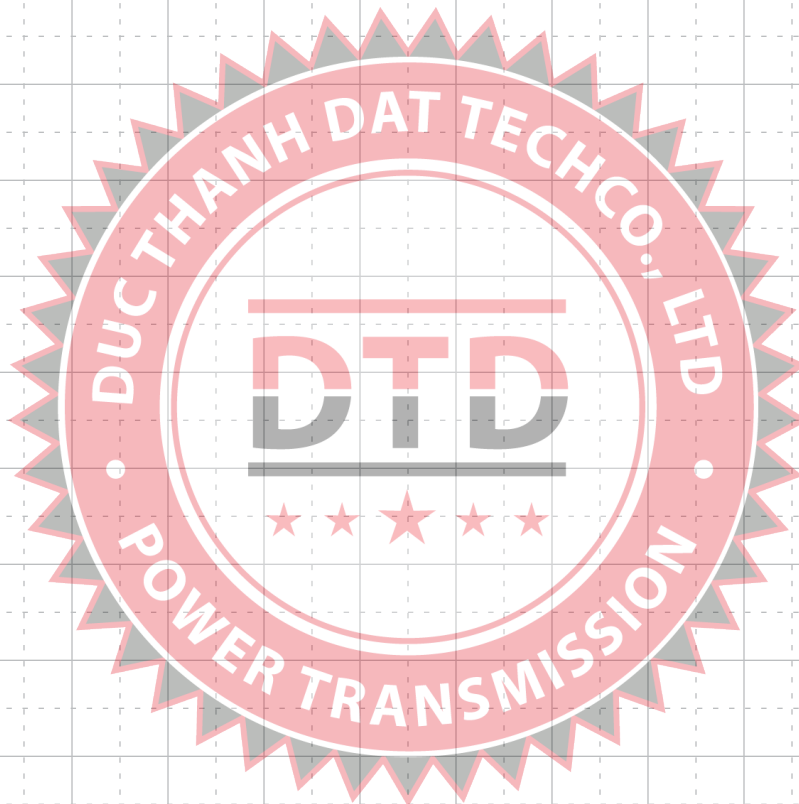

TERMS, CONDITIONS AND LIMITED WARRANTY OF SALE

All prices, terms and conditions of sale are subject to change without prior notice. Buyer agrees to all terms and conditions of seller upon the placement of any and all purchase orders.

GENERAL

- All orders are subject to a minimum charge of \$25.00
- All claims must be made within seven (7) days of receipt of merchandise.
- The company reserves the right at all times to reject any and all orders for any reason.

PAYMENT TERMS

- Net 30 days (to approved and qualified accounts)
- We reserve the right to hold shipments against past due accounts.
- Seller may require full or partial payment in advance if, in its sole judgement, the financial condition of the buyer does not justify the terms specified.
- All past due accounts are subject to a late payment charge of 1.5% per month, or maximum allowed by law if different, along with the expenses incidental to collection including reasonable attorney's fees
- Returned checks are subject to a minimum \$50.00 charge.

ACCEPTANCE, ALTERATION AND CANCELLATION OF ORDERS

Orders for other than standard items or standard lengths may not be cancelled after purchase has been committed, production scheduled or any costs incurred.

RETURN OF DEFECTIVE MERCHANDISE

Defective or failed material to be held at the buyer's premises until authorization has been granted by seller to return or dispose of merchandise. Merchandise to be returned for final inspection must be returned Freight Prepaid in the most economical way. Credit will be issued for material found to be defective upon our inspection based on prices at time of purchase.

MERCHANDISE SHIPPED IN ERROR

Buyer must notify seller immediately on any merchandise shipped in error. Upon notification, merchandise is to be returned to seller either via truck on a Freight Collect basis, via carrier of our choice, or via UPS on a Freight Prepaid basis. Buyer will be reimbursed for cost of merchandise, plus any additional freight which may have been incurred due to shipping error.

MERCHANDISE ORDERED IN ERROR

Standard packaged merchandise only may be returned, provided that the merchandise is in the original buyer's possession not more than 30 days. If merchandise is accepted for return, merchandise must be returned Freight Prepaid, and buyer will be charged a minimum of 15% rehandling charge, plus a chargeback for outbound freight charges if the original order was shipped prepaid. Returns are not accepted for any merchandise that is specifically manufactured to meet the buyer's requirement of either specifications or large quantity.

DELIVERY, DAMAGES, SHORTAGES

Delivery to the initial common carrier shall constitute the delivery to the buyer. Our responsibility, insofar as transportation risks are concerned, ceases upon the delivery of the merchandise in good condition to such a carrier, and all the merchandise shall be shipped at the buyer's risk.

GOODS DAMAGED IN SHIPMENT

Upon receipt of shipment, any evidence of damage to original shipping package must be reported by the receiving party and a claim made with the delivering carrier upon receipt of shipment.

CONCEALED DAMAGE

Any evidence of damage to material shipped, upon the opening of the original shipping package, must be reported by the receiving party to and a claim made with the delivering carrier without delay.

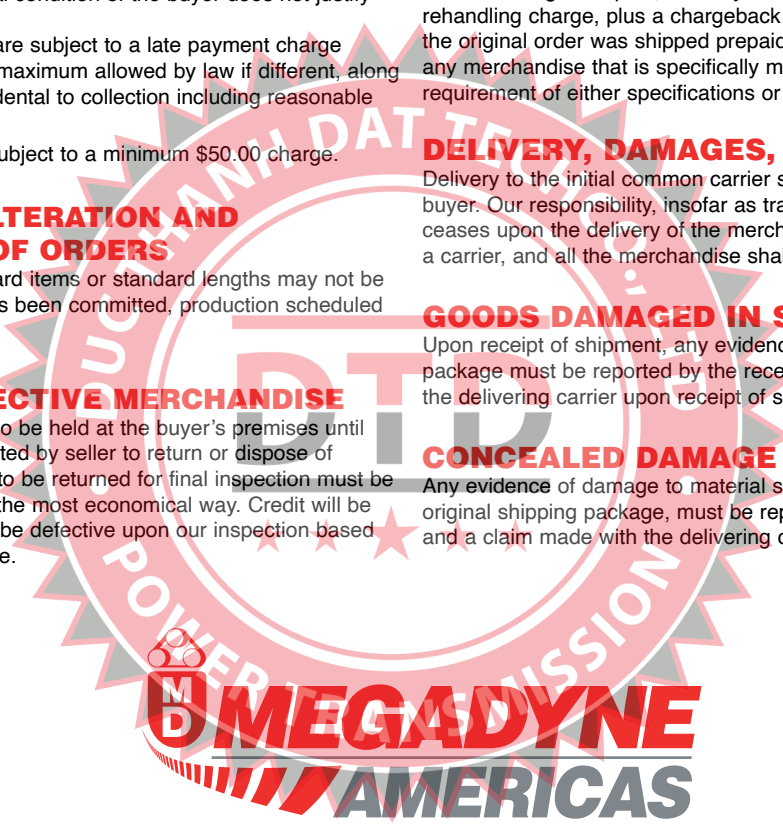

LIMITED WARRANTY

The merchandise or products sold or distributed by Megadyne America are warranted to our customers to be free from defects in material and workmanship at the time of shipment by us. All warranty claims shall be made within 90 days after we have shipped the merchandise. Our liability hereunder is limited to the purchase price of any merchandise proved defective, or, at our option, to the replacement of such merchandise upon its authorized return to us.

THIS WARRANTY IS IN LIEU OF AND EXCLUDES ALL OTHER WARRANTIES, EXPRESSED, IMPLIED, STATUTORY, OR OTHERWISE CREATED UNDER APPLICABLE LAW INCLUDING, BUT NOT LIMITED TO, THE WARRANTY OF MERCHANTABILITY AND THE WARRANTY OF FITNESS FOR A PARTICULAR PURPOSE. IN NO EVENT SHALL WE BE LIABLE FOR SPECIAL, INCIDENTAL, OR CONSEQUENTIAL DAMAGES, INCLUDING LOSS OF PROFITS.

Copyright Notice: Megadyne America LLC copyright. All rights reserved. Megadyne is and shall remain the owner of all right on drawings, technical specifications and any other information contained in the present catalog or otherwise communicated by Megadyne America LLC to the customer. The customer shall not disclose such information to third parties or use such information for purposes different from the definition of the order to Megadyne America LLC, unless upon prior written authorization of Megadyne.

See inside cover for all other Trademark information.

BELARUS**Minsk**

Phone +375 17 2802486
Info.by@megadynegroup.com

BRAZIL**Sorocaba**

Phone +55 15 2101 7700
Info.br@megadynegroup.com

CANADA**Edmonton**

Phone +1 780 461 4400
Info.ca@megadynegroup.com

Montreal

Phone +1 514 31 2341
Info.ca@megadynegroup.com

Toronto

Phone +1 905 602 4400
Info.ca@megadynegroup.com

CHINA**Beijing**

Phone +86 10 8150 7478
info.cn@megadynegroup.com

Foshan

Phone +86 757 83815530
info.cn@megadynegroup.com

Fujian

Phone +86 595 8816 0309
info.cn@megadynegroup.com

Ningbo*

Phone +86 574 8650 2886
info.cn@megadynegroup.com

Qingdao*

Phone +86 532 8765 2117
info.cn@megadynegroup.com

Shanghai

Phone +86 21 5447 1473
info.cn@megadynegroup.com

Shenyang

Phone +86 24 2572 3238
info.cn@megadynegroup.com

COLOMBIA**Bogotá**

Phone +57 (1) 471 0503
Info.co@megadynegroup.com

Cartagena

Phone +57 (5) 672 997
Info.co@megadynegroup.com

CZECH REPUBLIC**Prague**

Phone +420 2 8481 7181
Info.cz@megadynegroup.com

FRANCE**Paris**

Phone +33 1 6079 8200
info.fr@megadynegroup.com

St. Jean De Maurienne*

Phone +33 4 7964 0613
info.fr@megadynegroup.com

GERMANY**Borchen**

Phone +49 5251 8735 0
info.de@megadynegroup.com

Elchingen*

Phone +49 7308 9665 0
info.de@megadynegroup.com

HUNGARY**Budapest**

Phone +36 23 428 628
info.hu@megadynegroup.com

INDIA**Chennai***

Phone +91 98841 81175
info.in@megadynegroup.com

ISRAEL**Caesarea**

Phone +972 4 6371485
sales@megabelt.co.il

ITALY**Turin***

Phone +39 011 926 8052
info@megadynegroup.com

Milan*

Phone +39 039 689 601
info.it@megadynegroup.com

Pescara

Phone +39 085 9700547
info.it@megadynegroup.com

Venice

Phone: +39 041 929 367
info.it@megadynegroup.com

MEXICO**Mexico C.P.**

Phone +52 55 5587 3680
info.mx@megadynegroup.com

PERU**Lima**

Phone +51 713 0069
info.pe@megadynegroup.com

POLAND**Bydgoszcz***

Phone +48 52 348 77 12
info.pl@megadynegroup.com

SOUTH AFRICA**Johannesburg**

Phone +27 (0)12 661 1652
info.za@megadynegroup.com

Cape Town

Phone +27 (0)21 982 0772
info.za@megadynegroup.com

SPAIN**Barcelona***

Phone +34 933 774 441
www.avetm.com

Vilanova*

Phone +34 93 811 5450
info.es@megadynegroup.com

SWEDEN**Kristianstad**

Phone +46 10 1309600
info.se@megadynegroup.com

THAILAND**Bangkok**

Phone: +66 (0) 27115477
info.th@megadynegroup.com

TURKEY**Izmir***

Phone +90 232 877 07 00
info.tr@megadynegroup.com

U.K.**Birmingham**

Phone: +44 1384 215 021
info.uk@megadynegroup.com

U.S.A**California**

Phone +1 323 265 8061
info.us@megadynegroup.com

Florida

Phone +1 813 241 4111
info.us@megadynegroup.com

Georgia*

Phone +1 770 887 9725
info.us@megadynegroup.com

Illinois

Phone +1 630 752 0600
info.us@megadynegroup.com

New Jersey Americas HQ

Phone +1 973 227 4904
info.us@megadynegroup.com

New York*

Phone +1 716 667 7450
info.us@megadynegroup.com

North Carolina*

Phone +1 704 583 5388
info.us@megadynegroup.com

Oregon

Phone +1 503 231 7224
info.us@megadynegroup.com

Texas

Phone +1 972 438 6992
info.us@megadynegroup.com

HEADQUARTERS**ITALY Turin**

Via S. Lucia, 114
10075 Mathi (Torino)
Phone +39 011 926 8052
info@megadynegroup.com

www.megadynegroup.com
www.jasonbymegadyne.com

* Manufacturing locations



**LAWN, GARDEN &
FARM EQUIPMENT
BELTING**

**MXV™ Series OEM
FHP Multi-Plus®**

**JASON®
INDUSTRIAL**

Jason Industrial[®] manufactures and delivers a comprehensive inventory of rubber and polyurethane synchronous belts, rubber v-belts, industrial hose and couplings, plus hardware to the industrial community worldwide.

When extraordinary needs require specialized components, we will work with you from prototype to production, creating custom solutions that suit your unique application.

As a Jason Industrial customer, you can feel confident in the quality and integrity of our products, the speed and efficiency at which they are delivered, and the expertise and customer focus that our local representatives are committed to providing.

Jason's corporate headquarters are based in Fairfield, New Jersey. Our distribution center is located just outside of Chicago, Illinois, with additional corporate offices in Canada, Mexico, Brazil and Colombia, as well as manufacturing, warehousing and distribution centers in cities across the globe.

Welcome to Jason Industrial... the first name in mechanical rubber and urethane products that power industry forward.



WARNING: This catalog contains products that can expose you to chemicals including carbon black and/or lead which are known in the state of California to cause cancer, birth defects or other reproductive harm. For more information visit www.P65WARNINGS.ca.gov

BELT GUIDE

Catalog	4
Online Cross Reference Tool	5
Belt Nomenclature & Types	6-7

LAWN & GARDEN

MXV™ Lawn & Garden Premium Belts	8-9
----------------------------------	-----

RUBBER V-BELTS

Fractional Horsepower (FHP)	3L	10
UniMatch® Classical Multi-Plus®	A, B, C, D, E	11-13
Centrifugal (PTO) Replacement Belts	ACE / HYPRO	13
Double-V (Hexagonal) Classical	AA, BB, CC	14-15
Cogged Raw Edge V-Belt	AX, BX, CX	16-17
Accu-Link® Link Type Belt	3L, A, B, C	18
V-Belt Tensioning, V-Belt Troubleshooting		19
OEM Replacement Belts	AYP, Bobcat/Ransomes, Castel Garden, MTD, Murray, Simplicity, Snapper	20-21
V-Belt Accessories		55
Terms, Conditions & Limited Warranty of Sale		56

CROSS REFERENCE - Lawn & Garden Equipment Part Numbers 22-34

Aircap, Allis Chalmers/Deutz, Ariens/Gravely	22
AYP	22-24
Billey Goat, Bobcat/Ransomes, Bolens	24
Briggs & Stratton (Murray)	24-25
Bunton	25
Craftsman	25-26
Cub Cadet, Dixon, Edco, Encore, Excel, Exmark, Ford	26
Gilson	26-27
Grasshopper, Gravely, Haban, Homelite, Homko, Honda, Huskee/Husky	27
Husqvarna	27-28
Jacobson	28
John Deere	28-29
Kees/Yazoo, Lawn Chief, Lawn-Boy, Massey, Maxim, McColloch, Merry Tiller, Mighty Mac	29
Montgomery Ward	29-30
Moto-Mower, Mott	30
MTD	30-31
NOMA/AMF/Dynamark, Poulan	31

TABLE OF CONTENTS

CROSS REFERENCE - Lawn & Garden Equipment Part Numbers (continued)

<i>Rasor</i>	31-32
<i>Roof, Scag, Simplicity</i>	32
<i>Snapper</i>	32-33
<i>Toro/Wheel, Troy Bilt</i>	33
<i>Western</i>	33-34
<i>Yamaha, Yardman</i>	34

CROSS REFERENCE - AG Equipment Part Numbers 35-54

<i>Ace Pump, AG Chemical</i>	35
<i>Allis Chalmers/Gleemer</i>	35-36
<i>Alloway</i>	36
<i>Anthes West, Applequist, Arbos Italy, Arts Way, Atlas Metal, Auburn Con, Auburn Industries Automatic, BMB Mfg., Badger Northland, Balzer, Barrantine, Bear Cat, Blackwelders, Blair Man., Brady, Brandt, Brillion Iron, Brown, Bush Hog, Butler Mfg., CCIL, CFE, E.L. Caldwell, Calkins</i>	37
<i>Canadian Co-Op, Cardinal, Carter</i>	38
<i>Case - I H</i>	38-40
<i>Caterpillar, Central Texas Irrigation</i>	40
<i>Claas</i>	40-41
<i>Claeys, Clark, Equipment, Clay Equipment, Cleveland Farm, Colt Man., Coltec Industries, Continental Belton, Contree, Cross Equipment, Custom Farm, DK Mfg., Daffin, Danuser, David Mfg., Desert Irrigation, Deweze, Distrivelez, Dresser Industries, Dura Corp., Edwards Equipment, Elliot Mfg., Enid Foundry, Eversman</i>	41
<i>Excel Industries, Farmhand, Farrar Machine, Field Queen, Finn Corp., Fleming Mfg., Food Machine</i>	42
<i>Ford/New Holland</i>	42-43
<i>Formallo, Foster, Fox Brady (Koehring), Freeman & Sons, Frick</i>	43
<i>Friggstad Mfg., G.T. Sales & Mfg., Gehl Co., Gilmore Tatge Mfg., Glisson</i>	44
<i>Goossen Ind., Graves, Green Isle, Grider, G.H. Grimm Grove Mfg., Habco, Hahn Inc., Hamacheck, Hammersmith, R.A. Hanson, Harnischfeger, Harris Harvester, Hart Carter, Haybuster, HCC Corp., Heath, Henke Machine, Henry Ind.</i>	44-45
<i>Hesston</i>	44-45
<i>Hevco, Hiniker, Hob Tool, Hobbs Engineering, Hutchinson Division, Hydra Mac, Imperial Steel, Industrial Albajar, Ingalls Mfg.</i>	45
<i>Innes</i>	45-46
<i>Jacobs Tool, Jacobson Mfg., James Mfg., Jebco, Jet Flow, John Bean, John Blue</i>	46
<i>John Deere</i>	46-48

Johnson Farm, KBH, Kasten, Keith Industries, Kelley Mfg. Kelly Ryan, Kent Mfg., 48
 Kinze, Kitson Poultry, Koehring, Kosch, Krone, Kubota, Kuhn, Kuker, Laidig,
 Landpride, Lennox, Lewis, Lilliston, Lockwood Corp., Long Mfg.

CROSS REFERENCE - AG Equipment Part Numbers (continued)

J.E. Love 48-49
 Luedke, Lundel, Macdon, Maize 49
 Massey Ferguson 49-50
 Mayrath, McConnell Mfg., McKee, Melos Mfg. 50
 Melroe 50-51
 MI-T-M, Mitsubishi, Mono Mfg., Moody Mfg., Mooers Machinery, Moridge Mfg. 51
 Mott Mfg., New Idea, Oppel Harvester, Owatonna Mfg., PK Mfg., Parma,
 Ben Pearson, Peerless, Pennington, Polaris, Powell Mfg., Pug Mfg., Ramacher,
 Redbill, Renn
 Rivinius, Robin Nodwell, Rodgers Mfg., Root Mfg., Roskamp Mfg., Rotech, Rowse 52
 Hydraulics Rakes, SE Spray Equipment, S/G Mfg., Sakundiak, Schuler,
 Scoop-a-Second, Shaw, Shellman, Shinn, Simplex Mfg., Sioux Tool, Smalley,
 Snow Corp., South Bend Farm, Speed King, Speedy Mfg., Starline, Steiger Tractor,
 Sund Mfg., Sunmaster, Superior Equipment, Thiokol, Thompson, Tote Co., Triple C,
 Tyler, United Farm Tool, Utah Agriculture, Van Dale, Vermeer, Versatile
 Vicon, Viking, Volvo/Penta, Walsh, Western Land Roller, Westfield, 53
 Western Pulverizer
 White Farm Equipment • 53-54
 Willmar, Wil-Rich, Woods & Copeland, Woods Division/Hesston, Wright Stander, 54
 Wyatt, Yanmar, Year-Around Cab



HOW TO USE JASON INDUSTRIAL'S CROSS REFERENCE GUIDE

IN THIS CATALOG:

1. Simply look up the OEM manufacturer's part number on pages 22-34 for Lawn & Garden Equipment. For AG Equipment & Pumps, see pages 35-54. Listed next to it is a cross-reference to MXV™ or standard Multi-Plus® belts. Special OEM belts are listed on pages 20-21.
2. What if the belt I am trying to replace has no part number on it (or I can't read it)? Using the Belt Construction Reference on page 6, determine the cross-section, then measure the outside length of the belt.

For example, a belt that has a 1/2" top width and outside measurement of 35" would be cross-referenced into either an A33(4L350) or a MXV4-350 (Super Duty).

3. Which do I use - MXV™ or Standard Multi-Plus® belts?

Most manufacturer's part numbers can be cross-referenced into either a standard Multi-Plus® belt or a Super Duty MXV™ belt. If given a choice, we recommend the MXV™ belt, for lawn and garden equipment. The aramid cord in this belt provides longer life. An MXV™ belt may be substituted for a standard Multi-Plus® belt. However, a Multi-Plus® belt can not be substituted for an MXV™ belt.

SOME GUIDELINES IN DECIDING WHICH TYPE OF BELT TO USE:

HORSEPOWER - Whenever the motor horsepower is greater than 5 or the service life of a Multi-Plus® belt is less than desired, move up to the premium MXV™ Super Duty belt.

CLUTCHING - If the belt is used in a clutching application, use the MXV™ Super Duty belt. The cover fabric is specially designed to allow it to clutch. If clutching is not a requirement, the standard Multi-Plus® belt may be used.

BACKSIDE IDLER - The MXV™ belt is designed for longer life when used on a drive where a backside idler is used.

LAWN MOWERS - Due to the strength of it's aramid cords, the MXV™ belt is recommended for lawn mower applications.

All references to original equipment manufacturers, their trade names and their part numbers, listed in this catalog are used for identification purposes only. It is not our intention to imply that the merchandise is original equipment.

Any reference to Original Equipment Manufacturers, their trade names or stock numbers in this catalog is for identification purpose only.

The replacement recommendations contained in this catalog are not, in all cases, intended to be identical to the belt specifications of the original equipment manufacturer. Reasonable performance and availability are the major considerations in arriving at these selections. Where clutching drives are involved, extreme caution must be exercised to assure correct belt recommendations are used.

WARNING

Aramid Cord — Since MXV™ belts feature high strength aramid tensile cords, shocks can be transmitted that exceed the strength of some cast pulleys. Carefully check the condition of your equipment, keep all guards in place, and consult the manufacturer if replacing standard belts with high strength aramid cord belts on cast pulleys.

HOW TO USE JASON INDUSTRIAL'S ONLINE CROSS REFERENCING TOOL

ONLINE BELT GUIDE:

1. Search by accessing www.jasonindustrial.com
2. Go to Industries
3. Select Lawn & Garden
4. Select V-Belt Cross Reference Tool

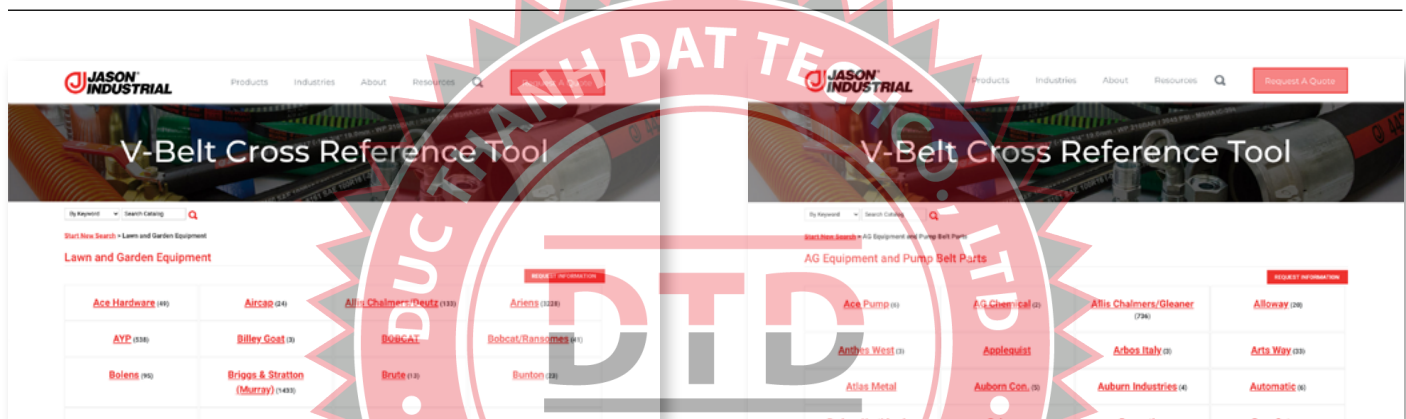
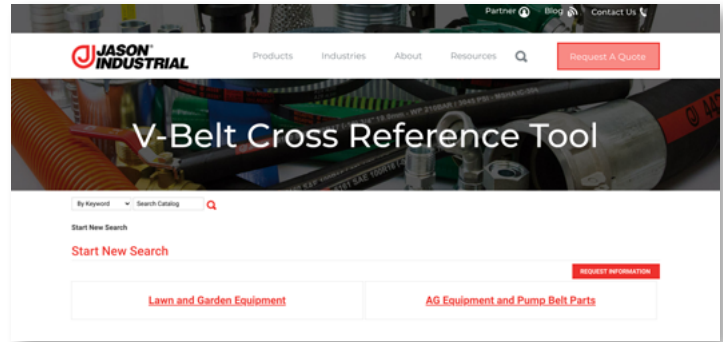

OR SCAN THIS CODE:

This link leads to:
<http://www.jasonindustrial.com/lg>



**For direct, quick access to our
 V-Belt Cross Reference Tool.**

FOUR WAYS TO SEARCH:

By Keyword

Start New Search

BY PART NUMBER

BY KEYWORD

BY MANUFACTURE'S PRODUCT
 NUMBER

BY MODEL NUMBER

DRIVE BELT NOMENCLATURE

V-Belt Type	Numbered By	Part Number	Outside Length
Lawn & Garden	Standard Length	MXV4-500	= 0.50"
Fractional HP	Effective Length	4L500	= 0.50"
Classical Multi-Plus	Standard Length Designation	A48	= 0.50"
Fractional HP	Effective Length	5L500	= 0.50"
Classical Multi-Plus	Standard Length Designation	B47	= 0.50"
Classical Cogged	Standard Length Designation	AX48	= 0.50"
Narrow Deep Wedge	Effective Length	5VX500	= 50"

Note: Length information values in the above table are approximate. Industry standards require that to properly measure a belt, it must be installed on a fixture with two pulleys of prescribed dimension and tensioned to a specific value. Accurate values cannot be measured by hand on a free length of belt.

ARAMID CORD FOR LAWN & GARDEN LIGHT DUTY FHP MXV™

Fractional HP

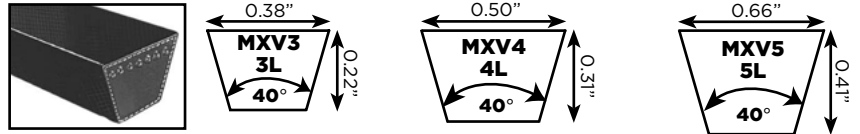

CLASSICAL HEAVY DUTY

Jason Multi-Plus® - UniMatch®

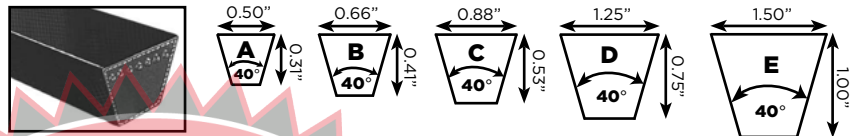

MOLDED COGGED

Cogged allows smaller pulleys. Better heat dissipation.

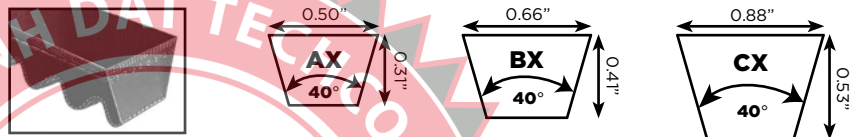

WEDGE

Narrower, deeper profile with higher power capability than classical v-belt. Allows for smaller, more compact drives.

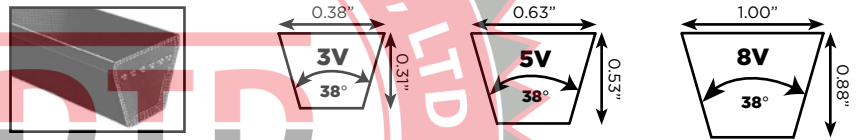

WEDGE COGGED

Same properties of Wedge. Cogged for greater flexibility and heat dissipation. Raw Edge Sidewalls (no fabric cover) prevent slippage.

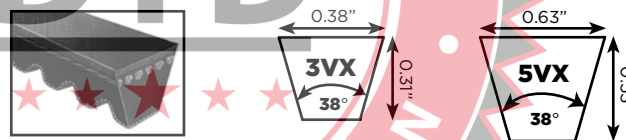

WRAPPED V-BELT

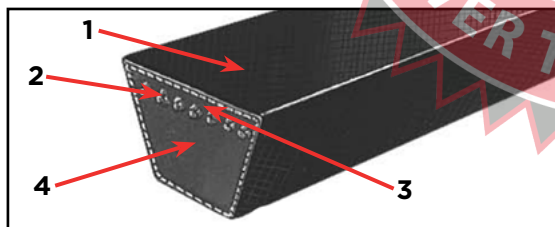

1. Cover - Rubberized Fabric

- Flexible, non-cracking, smooth running for long life
- Oil, heat & abrasion resistant

2. Load Section - Polyester Cords

- Positioned to take tension in both FHP & Classical applications
- Chemically treated, then fused prevents separation

3. Load Carrying Section

- Special compound to resist stretch & fatigue

4. Compression Section

- Elastomer resists compression fatigue
- Dissipates internal heat build-up
- Provides firm lateral pressure against groove sidewall and distributes the load to cords

RAW EDGE V-BELT

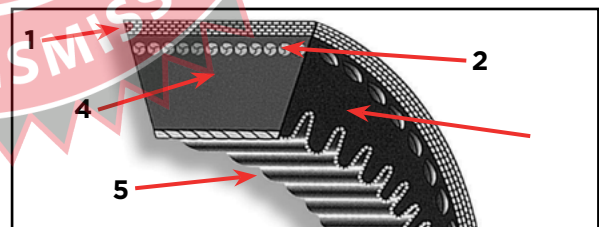

1. Top Fabric

- Provides heat and oil resistance

2. Load Section - Polyester Cords

- Provides uniform distribution of load

3. Raw Edge Sidewalls

- Increases grip/Improved efficiency through reduced slippage

4. Compression Section

- Elastomer resists compression fatigue
- Dissipates internal heat build-up
- Provides firm lateral pressure against groove sidewall and distributes the load to cords

5. Precision Moulded Cogs

- Provide flexibility and aid in heat dissipation



WARNING: These products can expose you to chemicals including carbon black which is known in the state of California to cause cancer, birth defects or other reproductive harm. For more information visit www.P65WARNINGS.ca.gov

THE PROFESSIONAL SELECTION

ARAMID CORD - (MXV) Super Duty

Professional Aramid Cord, premium wrapped belts are designed for engine powered applications and designed to handle the most demanding applications - from riding mowers to edgers and tillers. These belts have an extra long life, even when used in clutching and backside idler applications.

The Professional Aramid belts provide performance advantages over fractional horsepower belts:

- Aramid Cord provides a high tensile strength for severe shock load and stretch resistance. Aramid is pound for pound stronger than steel - it's the same material used in bullet proof vests!
- A lower cord position within the construction of the belt is a major performance advantage in backside idler applications.
- Our special clutching cover provides smooth engagement and prevents accidental engagement in clutching applications. This cover protects the belt from heat associated with clutching. It also allows smooth belt engagement and reduces the "grabbing" effect that can cause accidental belt engagement common with standard belts.



POLY CORD - (MULTI-PLUS®) Standard Duty

Professional Poly Cord belts are high quality standard duty replacement belts for use in less demanding applications, designed and constructed for electric motor powered applications. These belts are made from premium quality synthetic rubber compounds and feature high-strength polyester cords.



OEM Exact (XP) Replacement

The OEM Exact Replacement belts are of the highest quality, made to OEM specifications. These belts offer design, length and top width dimensions to meet or exceed OEM tolerances. While most of our Aramid and Poly Cord belts are interchangeable with the exact replacement belts we offer, if we make an OEM exact belt available, we recommend selecting that belt. We carry exact replacements because of their non-standard size or because we have determined that they offer superior performance.



MXV™ LAWN & GARDEN PREMIUM BELTS

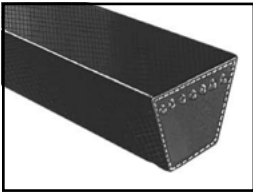

MXV™ Super Duty Lawn & Garden Belts - MXV3, MXV4, MXV5 (Tough Aramid Reinforcement)

These belts are ideal for lawn and garden applications. The special aramid tensile member guarantees excellent shock resistance while the bare back construction special cover assures smooth belt release and engagement in clutching applications. Special oil and heat resistant synthetic rubber.

Features & Benefits

- **Aramid Blend Tensile Member** - Low stretch tensile; resistant to shock load
- **Special Fiber Loaded Undercord** - Greater tensile member support
- **Blue Bare Back Cover** - Smooth, quiet operation on clutching applications
- **Thin Profile** - Flexible on small pulleys for long life

Construction

Compound - Oil & heat resistant synthetic rubber

Cord - Aramid Blend Tensile Member

Cover - Bare Back (no rubber impregnation)

Applications - Lawn & Garden, Agriculture, Pumps, Blowers, Fans, Woodworking Equipment, Hand Tools, Sprayers, Compressors

Engineering Standards - Conforms to ARPM standard IP-23

Recommended Pulleys - Use pulleys made to ARPM standards

Note - MXV belts have the same dimensions and tolerances as standard FHP belts.

PART NUMBER DESIGNATION

MXV4-300

MXV = Heavy Duty construction

4 = 0.50" Nominal Top Width

300 = Outside length in tenths of an inch = 30"

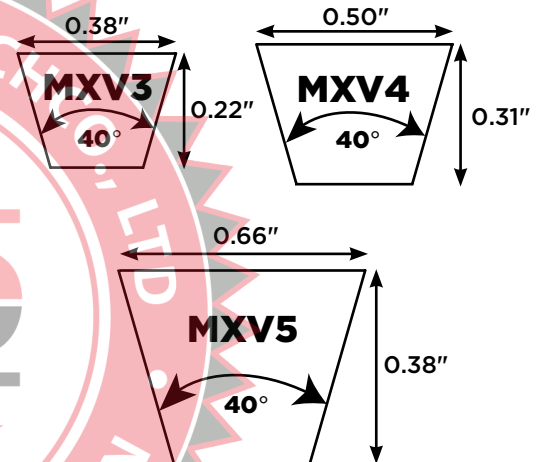

MXV3 LAWN & GARDEN BELT 0.38" TOP WIDTH x 0.22" THICK x 40° ANGLE

Belt Number	Outside Length (in.)	Approx. Weight (lbs.)	Belt Number	Outside Length (in.)	Approx. Weight (lbs.)	Belt Number	Outside Length (in.)	Approx. Weight (lbs.)	Belt Number	Outside Length (in.)	Approx. Weight (lbs.)
MXV3-200	20.0	0.08	MXV3-310	31.0	0.12	MXV3-420	42.0	0.17	MXV3-530	53.0	0.21
MXV3-210	21.0	0.08	MXV3-320	32.0	0.13	MXV3-430	43.0	0.17	MXV3-550	55.0	0.21
MXV3-220	22.0	0.09	MXV3-330	33.0	0.13	MXV3-440	44.0	0.18	MXV3-610	61.0	0.23
MXV3-230	23.0	0.09	MXV3-340	34.0	0.14	MXV3-450	45.0	0.18	MXV3-620	62.0	0.23
MXV3-240	24.0	0.10	MXV3-350	35.0	0.14	MXV3-460	46.0	0.18	MXV3-630	63.0	0.23
MXV3-250	25.0	0.10	MXV3-360	36.0	0.14	MXV3-470	47.0	0.19	MXV3-640	64.0	0.24
MXV3-260	26.0	0.10	MXV3-370	37.0	0.15	MXV3-480	48.0	0.19	MXV3-650	65.0	0.24
MXV3-270	27.0	0.11	MXV3-380	38.0	0.15	MXV3-490	49.0	0.19	MXV3-660	66.0	0.24
MXV3-280	28.0	0.11	MXV3-390	39.0	0.16	MXV3-500	50.0	0.20	MXV3-670	67.0	0.25
MXV3-290	29.0	0.12	MXV3-400	40.0	0.16	MXV3-510	51.0	0.20			
MXV3-300	30.0	0.12	MXV3-410	41.0	0.16	MXV3-520	52.0	0.20			



WARNING: These products can expose you to chemicals including carbon black which is known in the state of California to cause cancer, birth defects or other reproductive harm. For more information visit www.P65WARNINGS.ca.gov

MXV4 LAWN & GARDEN BELT 0.5" TOP WIDTH x 0.31" THICK x 40° ANGLE

Belt Number	Outside Length (in.)	Approx. Weight (lbs.)	Belt Number	Outside Length (in.)	Approx. Weight (lbs.)	Belt Number	Outside Length (in.)	Approx. Weight (lbs.)	Belt Number	Outside Length (in.)	Approx. Weight (lbs.)
MXV4-180	18.0	0.09	MXV4-500	50.0	0.23	MXV4-830	83.0	0.38	MXV4-1160	116.0	0.53
MXV4-190	19.0	0.09	MXV4-510	51.0	0.24	MXV4-840	84.0	0.39	MXV4-1170	117.0	0.54
MXV4-200	20.0	0.10	MXV4-520	52.0	0.24	MXV4-850	85.0	0.39	MXV4-1180	118.0	0.54
MXV4-210	21.0	0.10	MXV4-530	53.0	0.24	MXV4-860	86.0	0.40	MXV4-1190	119.0	0.55
MXV4-220	22.0	0.10	MXV4-540	54.0	0.25	MXV4-870	87.0	0.40	MXV4-1200	120.0	0.55
MXV4-230	23.0	0.11	MXV4-550	55.0	0.25	MXV4-880	88.0	0.41	MXV4-1210	121.0	0.56
MXV4-240	24.0	0.11	MXV4-560	56.0	0.26	MXV4-890	89.0	0.41	MXV4-1220	122.0	0.56
MXV4-250	25.0	0.12	MXV4-570	57.0	0.26	MXV4-900	90.0	0.42	MXV4-1260	126.0	0.58
MXV4-260	26.0	0.12	MXV4-580	58.0	0.27	MXV4-910	91.0	0.42	MXV4-1310	131.0	0.60
MXV4-270	27.0	0.12	MXV4-590	59.0	0.27	MXV4-920	92.0	0.42	MXV4-1320	132.0	0.61
MXV4-280	28.0	0.13	MXV4-600	60.0	0.28	MXV4-930	93.0	0.43	MXV4-1330	133.0	0.61
MXV4-290	29.0	0.13	MXV4-610	61.0	0.28	MXV4-940	94.0	0.43	MXV4-1340	134.0	0.62
MXV4-295	29.5	0.14	MXV4-620	62.0	0.29	MXV4-945	94.5	0.44	MXV4-1370	137.0	0.63
MXV4-300	30.0	0.14	MXV4-630	63.0	0.29	MXV4-950	95.0	0.44	MXV4-1380	138.0	0.64
MXV4-310	31.0	0.14	MXV4-640	64.0	0.30	MXV4-960	96.0	0.44	MXV4-1390	139.0	0.64
MXV4-320	32.0	0.15	MXV4-650	65.0	0.30	MXV4-970	97.0	0.45	MXV4-1400	140.0	0.65
MXV4-330	33.0	0.15	MXV4-660	66.0	0.30	MXV4-980	98.0	0.45	MXV4-1410	141.0	0.65
MXV4-340	34.0	0.15	MXV4-670	67.0	0.31	MXV4-990	99.0	0.46	MXV4-1420	142.0	0.65
MXV4-350	35.0	0.16	MXV4-680	68.0	0.31	MXV4-1000	100.0	0.46	MXV4-1440	144.0	0.66
MXV4-360	36.0	0.16	MXV4-690	69.0	0.32	MXV4-1010	101.0	0.47	MXV4-1450	145.0	0.67
MXV4-370	37.0	0.17	MXV4-700	70.0	0.32	MXV4-1020	102.0	0.47	MXV4-1460	146.0	0.67
MXV4-380	38.0	0.18	MXV4-710	71.0	0.33	MXV4-1030	103.0	0.48	MXV4-1470	147.0	0.68
MXV4-390	39.0	0.18	MXV4-720	72.0	0.33	MXV4-1040	104.0	0.48	MXV4-1480	148.0	0.68
MXV4-400	40.0	0.18	MXV4-730	73.0	0.34	MXV4-1050	105.0	0.48	MXV4-1490	149.0	0.69
MXV4-410	41.0	0.19	MXV4-740	74.0	0.34	MXV4-1060	106.0	0.50	MXV4-1500	150.0	0.69
MXV4-420	42.0	0.19	MXV4-750	75.0	0.35	MXV4-1070	107.0	0.50	MXV4-1510	151.0	0.70
MXV4-430	43.0	0.20	MXV4-760	76.0	0.35	MXV4-1080	108.0	0.50	MXV4-1520	152.0	0.70
MXV4-440	44.0	0.20	MXV4-770	77.0	0.36	MXV4-1090	109.0	0.50	MXV4-1540	154.0	0.71
MXV4-450	45.0	0.21	MXV4-780	78.0	0.36	MXV4-1100	110.0	0.51	MXV4-1620	162.0	0.75
MXV4-460	46.0	0.21	MXV4-790	79.0	0.36	MXV4-1110	111.0	0.51	MXV4-1630	163.0	0.75
MXV4-470	47.0	0.22	MXV4-800	80.0	0.37	MXV4-1120	112.0	0.52	MXV4-1640	164.0	0.76
MXV4-480	48.0	0.22	MXV4-810	81.0	0.37	MXV4-1130	113.0	0.52			
MXV4-490	49.0	0.23	MXV4-820	82.0	0.38	MXV4-1140	114.0	0.53			

MXV5 LAWN & GARDEN BELT 0.66" TOP WIDTH x 0.38" THICK x 40° ANGLE

Belt Number	Outside Length (in.)	Approx. Weight (lbs.)	Belt Number	Outside Length (in.)	Approx. Weight (lbs.)	Belt Number	Outside Length (in.)	Approx. Weight (lbs.)	Belt Number	Outside Length (in.)	Approx. Weight (lbs.)
MXV5-230	23.0	0.20	MXV5-650	65.0	0.56	MXV5-1070	107.0	0.93	MXV5-1540	154.0	1.33
MXV5-240	24.0	0.21	MXV5-660	66.0	0.57	MXV5-1080	108.0	0.93	MXV5-1550	155.0	1.34
MXV5-250	25.0	0.22	MXV5-670	67.0	0.58	MXV5-1090	109.0	0.94	MXV5-1560	156.0	1.35
MXV5-260	26.0	0.23	MXV5-680	68.0	0.59	MXV5-1100	110.0	0.95	MXV5-1570	157.0	1.36
MXV5-270	27.0	0.23	MXV5-690	69.0	0.60	MXV5-1110	111.0	0.95	MXV5-1580	158.0	1.37
MXV5-280	28.0	0.24	MXV5-700	70.0	0.61	MXV5-1120	112.0	0.97	MXV5-1590	159.0	1.38
MXV5-290	29.0	0.25	MXV5-710	71.0	0.61	MXV5-1130	113.0	0.98	MXV5-1620	162.0	1.40
MXV5-300	30.0	0.26	MXV5-720	72.0	0.62	MXV5-1140	114.0	0.99	MXV5-1630	163.0	1.41
MXV5-310	31.0	0.27	MXV5-730	73.0	0.63	MXV5-1150	115.0	0.99	MXV5-1640	164.0	1.42
MXV5-320	32.0	0.28	MXV5-740	74.0	0.64	MXV5-1160	116.0	1.00	MXV5-1650	165.0	1.43
MXV5-330	33.0	0.29	MXV5-750	75.0	0.65	MXV5-1170	117.0	1.01	MXV5-1660	166.0	1.44
MXV5-340	34.0	0.29	MXV5-760	76.0	0.66	MXV5-1180	118.0	1.02	MXV5-1670	167.0	1.44
MXV5-350	35.0	0.30	MXV5-770	77.0	0.67	MXV5-1190	119.0	1.03	MXV5-1680	168.0	1.45
MXV5-360	36.0	0.31	MXV5-780	78.0	0.67	MXV5-1200	120.0	1.04	MXV5-1700	170.0	1.47
MXV5-370	37.0	0.32	MXV5-790	79.0	0.68	MXV5-1210	121.0	1.05	MXV5-1730	173.0	1.50
MXV5-380	38.0	0.33	MXV5-800	80.0	0.69	MXV5-1220	122.0	1.06	MXV5-1750	175.0	1.51
MXV5-390	39.0	0.34	MXV5-810	81.0	0.70	MXV5-1230	123.0	1.06	MXV5-1760	176.0	1.52
MXV5-400	40.0	0.35	MXV5-820	82.0	0.71	MXV5-1250	125.0	1.08	MXV5-1800	180.0	1.56
MXV5-410	41.0	0.35	MXV5-830	83.0	0.72	MXV5-1260	126.0	1.09	MXV5-1810	181.0	1.57
MXV5-420	42.0	0.36	MXV5-840	84.0	0.73	MXV5-1270	127.0	1.10	MXV5-1820	182.0	1.57
MXV5-430	43.0	0.37	MXV5-850	85.0	0.74	MXV5-1290	129.0	1.12	MXV5-1830	183.0	1.58
MXV5-440	44.0	0.38	MXV5-860	86.0	0.75	MXV5-1300	130.0	1.12	MXV5-1850	185.0	1.60
MXV5-450	45.0	0.39	MXV5-870	87.0	0.75	MXV5-1310	131.0	1.13	MXV5-1860	186.0	1.61
MXV5-460	46.0	0.40	MXV5-880	88.0	0.76	MXV5-1320	132.0	1.14	MXV5-1890	189.0	1.63
MXV5-470	47.0	0.41	MXV5-890	89.0	0.77	MXV5-1330	133.0	1.15	MXV5-1900	190.0	1.64
MXV5-480	48.0	0.42	MXV5-900	90.0	0.78	MXV5-1340	134.0	1.16	MXV5-1920	192.0	1.68
MXV5-490	49.0	0.42	MXV5-910	91.0	0.79	MXV5-1350	135.0	1.17	MXV5-1960	196.0	1.70
MXV5-500	50.0	0.43	MXV5-920	92.0	0.80	MXV5-1360	136.0	1.18	MXV5-1990	199.0	1.72
MXV5-510	51.0	0.44	MXV5-930	93.0	0.80	MXV5-1370	137.0	1.19	MXV5-2010	201.0	1.74
MXV5-520	52.0	0.45	MXV5-940	94.0	0.81	MXV5-1380	138.0	1.19	MXV5-2020	202.0	1.75
MXV5-530	53.0	0.46	MXV5-950	95.0	0.82	MXV5-1390	139.0	1.20	MXV5-2050	205.0	1.78
MXV5-540	54.0	0.47	MXV5-960	96.0	0.83	MXV5-1400	140.0	1.21	MXV5-2080	208.0	1.80
MXV5-550	55.0	0.48	MXV5-970	97.0	0.84	MXV5-1410	141.0	1.22	MXV5-2190	219.0	1.89
MXV5-560	56.0	0.48	MXV5-980	98.0	0.85	MXV5-1420	142.0	1.23	MXV5-2260	226.0	1.95
MXV5-570	57.0	0.49	MXV5-990	99.0	0.86	MXV5-1430	143.0	1.24	MXV5-2360	236.0	2.02
MXV5-580	58.0	0.50	MXV5-1000	100.0	0.87	MXV5-1450	145.0	1.25	MXV5-2380	238.0	2.03
MXV5-590	59.0	0.51	MXV5-1010	101.0	0.87	MXV5-1470	147.0	1.27	MXV5-2420	242.0	2.09
MXV5-600	60.0	0.52	MXV5-1020	102.0	0.88	MXV5-1480	148.0	1.28	MXV5-2520	252.0	2.19
MXV5-610	61.0	0.53	MXV5-1030	103.0	0.89	MXV5-1490	149.0	1.29	MXV5-2640	264.0	2.28
MXV5-620	62.0	0.54	MXV5-1040	104.0	0.90	MXV5-1500	150.0	1.30			
MXV5-630	63.0	0.54	MXV5-1050	105.0	0.91	MXV5-1510	151.0	1.31			
MXV5-640	64.0	0.55	MXV5-1060	106.0	0.92	MXV5-1520	152.0	1.31			

 **WARNING:** These products can expose you to chemicals including carbon black which is known in the state of California to cause cancer, birth defects or other reproductive harm. For more information visit www.P65WARNINGS.ca.gov

V-BELTS

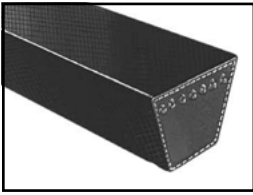

Fractional Horsepower (FHP) V-Belts - 3L Section

Fractional Horsepower (FHP) V-Belts are ideal for HVAC equipment, appliances, outdoor power equipment, lawn & garden, and various industrial applications. Generally, 3L FHP belts are used individually on drives of 1 horsepower or less.

Features & Benefits

- **Oil & Heat Resistant** - Durability in tough environments
- **Flexibility** - Ideal for use with backside idlers
- **Static Dissipating** - Safe operation in potentially dangerous atmosphere

Construction

Compound - Natural Rubber/SBR

Cord - Polyester

Cover - Cotton/Polyester blend

Applications - HVAC Equipment, Lawn & Garden, Appliances, General Industry

Engineering Standards - Conforms to RMA standard IP 23

Recommended Pulleys - Use pulleys made to ARPM standards

Note - Effective length is approximately equal to outside length

PART NUMBER DESIGNATION

3L130

3 = Belt top width in increments of one-eighth inch = 3/8"

L = Light Duty (FHP)

130 = Outside length in tenths of an inch = 13"

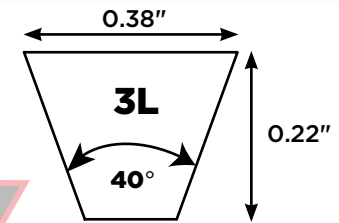

3L SECTION 0.38" TOP WIDTH x 0.22" THICKNESS x 40° ANGLE

Belt Number	Outside Length (in.)	Approx. Weight (lbs.)	Belt Number	Outside Length (in.)	Approx. Weight (lbs.)	Belt Number	Outside Length (in.)	Approx. Weight (lbs.)	Belt Number	Outside Length (in.)	Approx. Weight (lbs.)
3L130	13.0	0.04	3L290	29.0	0.10	3L450	45.0	0.15	3L610	61.0	0.20
3L140	14.0	0.04	3L300	30.0	0.10	3L460	46.0	0.15	3L620	62.0	0.20
3L150	15.0	0.04	3L310	31.0	0.11	3L470	47.0	0.16	3L630	63.0	0.20
3L160	16.0	0.04	3L315	31.5	0.11	3L475	47.5	0.16	3L640	64.0	0.21
3L170	17.0	0.06	3L320	32.0	0.11	3L480	48.0	0.16	3L650	65.0	0.21
3L180	18.0	0.06	3L330	33.0	0.11	3L490	49.0	0.16	3L660	66.0	0.21
3L190	19.0	0.06	3L340	34.0	0.11	3L500	50.0	0.17	3L670	67.0	0.22
3L200	20.0	0.07	3L350	35.0	0.12	3L510	51.0	0.17	3L680	68.0	0.22
3L210	21.0	0.07	3L360	36.0	0.12	3L520	52.0	0.17	3L690	69.0	0.22
3L220	22.0	0.07	3L370	37.0	0.12	3L530	53.0	0.18	3L700	70.0	0.22
3L230	23.0	0.08	3L380	38.0	0.13	3L540	54.0	0.18	3L710	71.0	0.22
3L240	24.0	0.08	3L390	39.0	0.13	3L550	55.0	0.19	3L720	72.0	0.23
3L250	25.0	0.08	3L400	40.0	0.13	3L560	56.0	0.19	3L730	73.0	0.23
3L260	26.0	0.09	3L410	41.0	0.14	3L570	57.0	0.19	3L740	74.0	0.23
3L270	27.0	0.09	3L420	42.0	0.14	3L580	58.0	0.20	3L750	75.0	0.24
3L280	28.0	0.09	3L430	43.0	0.15	3L590	59.0	0.20	3L760	76.0	0.24
3L285	28.5	0.09	3L440	44.0	0.15	3L600	60.0	0.20			



WARNING: These products can expose you to chemicals including carbon black which is known in the state of California to cause cancer, birth defects or other reproductive harm. For more information visit www.P65WARNINGS.ca.gov



UniMatch® Classical Multi-Plus® - A, B, C, D, E

Jason/Megadyne's Multi-Plus® V-Belts are designed to perform in tandem in multiple V-Belt drives, maintaining drive efficiency and classical belt performance. Multi-Plus® V-Belts are always matched, easy to install and maintain. Jason Multi-Plus® V-Belts come in a complete range of sizes, are anti-static and offer oil and heat resistance meeting RMA requirements.

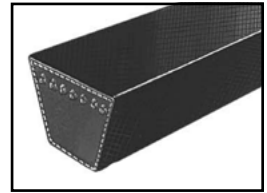

Dual Branding – A and B section belts up to 100" are Dual Branded clearly identifying both RMA classical and fractional

horsepower (FHP) sizes allowing consolidation of your classical and FHP inventory into one belt line – saving you money! No need to carry two separate product lines. The dual part number system is more than just labeling, too. FHP & Classical belts have the same top width dimension but classical profile is deeper, allowing more belt/pulley contact and reducing sheave wear.

Dual Branding Example: A40 (4L420), B78 (5L810)

Features & Benefits

- **UniMatch® Construction** - Consistent performance in multiple V-Belt drives - ensures all belts will measure within ARPM matching standards
- **Dual Branding** - A & B sections dual-branded with classical and FHP part numbers - reduces inventory by allowing you to discontinue 4L and 5L
- **Oil & Heat Resistant** - Durability in tough environments

Construction

Compound - Natural Rubber/SBR

Cord - Polyester

Cover - Cotton/Polyester blend

Applications - General Industry, HVAC Equipment, Lawn & Garden, Agriculture

Engineering Standards - Conforms to ARPM standard IP 20

Recommended Pulleys - Use pulleys made to ARPM standards standards

"A" SECTION 0.5" TOP WIDTH x 0.31" THICKNESS x 40° ANGLE

- **Note** - For A Section, add 2 inches for outside length - Example: A15 + 2 inches = 17" approximate outside length

PART NUMBER DESIGNATION

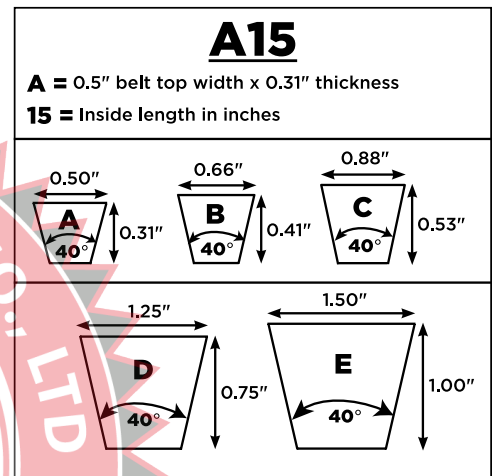

WARNING: These products can expose you to chemicals including carbon black which is known in the state of California to cause cancer, birth defects or other reproductive harm. For more information visit www.P65WARNINGS.ca.gov

Belt Number	Outside Length (in.)	Approx. Weight (lbs.)	Belt Number	Outside Length (in.)	Approx. Weight (lbs.)	Belt Number	Outside Length (in.)	Approx. Weight (lbs.)	Belt Number	Outside Length (in.)	Approx. Weight (lbs.)
A15A (4L170)	17.0	0.10	A47 (4L490)	49.0	0.30	A79 (4L810)	114.0	0.80	A112	114.0	0.80
A16A (4L180)	18.0	0.10	A48 (4L500)	50.0	0.30	A80 (4L820)	115.0	0.80	A113	115.0	0.80
A17A (4L190)	19.0	0.10	A49 (4L510)	51.0	0.30	A81 (4L830)	116.0	0.80	A114	116.0	0.80
A18 (4L200)	20.0	0.10	A50 (4L520)	52.0	0.30	A82 (4L840)	117.0	0.80	A115	117.0	0.80
A19 (4L210)	21.0	0.10	A51 (4L530)	53.0	0.30	A83 (4L850)	118.0	0.80	A116	118.0	0.80
A20 (4L220)	22.0	0.10	A52 (4L540)	54.0	0.30	A84 (4L860)	120.0	0.80	A118	120.0	0.80
A21 (4L230)	23.0	0.10	A53 (4L550)	55.0	0.30	A85 (4L870)	121.0	0.80	A119	121.0	0.80
A22 (4L240)	24.0	0.15	A54 (4L560)	56.0	0.30	A86 (4L880)	122.0	0.80	A120	122.0	0.80
A23 (4L250)	25.0	0.20	A55 (4L570)	57.0	0.30	A87 (4L890)	126.0	0.80	A124	126.0	0.80
A24 (4L260)	26.0	0.20	A56 (4L580)	58.0	0.30	A88 (4L900)	130.0	0.80	A128	130.0	0.80
A25 (4L270)	27.0	0.20	A57 (4L590)	59.0	0.30	A89 (4L910)	132.0	0.80	A130	132.0	0.80
A26 (4L280)	28.0	0.20	A58 (4L600)	60.0	0.30	A90 (4L920)	135.0	0.80	A133	135.0	0.80
A27 (4L290)	29.0	0.20	A59 (4L610)	61.0	0.30	A91 (4L930)	136.0	0.80	A134	136.0	0.80
A28 (4L300)	30.0	0.20	A60 (4L620)	62.0	0.30	A92 (4L940)	137.0	0.90	A135	137.0	0.90
A29 (4L310)	31.0	0.20	A61 (4L630)	63.0	0.30	A93 (4L950)	138.0	0.90	A136	138.0	0.90
A30 (4L320)	32.0	0.20	A62 (4L640)	64.0	0.30	A94 (4L960)	139.0	0.90	A137	139.0	0.90
A31 (4L330)	33.0	0.20	A63 (4L650)	65.0	0.30	A95 (4L970)	142.0	0.95	A140	142.0	0.95
A32 (4L340)	34.0	0.20	A64 (4L660)	66.0	0.30	A96 (4L980)	146.0	1.00	A144	146.0	1.00
A33 (4L350)	35.0	0.20	A65 (4L670)	67.0	0.30	A97 (4L990)	159.0	1.10	A148	150.0	1.00
A34 (4L360)	36.0	0.20	A66 (4L680)	68.0	0.40	A98 (4L1000)	160.0	1.10	A156	158.0	1.09
A35 (4L370)	37.0	0.20	A67 (4L690)	69.0	0.40	A99	162.0	1.10	A157	159.0	1.10
A36 (4L380)	38.0	0.20	A68 (4L700)	70.0	0.40	A100	175.0	1.15	A158	160.0	1.10
A37 (4L390)	39.0	0.20	A69 (4L710)	71.0	0.40	A101	182.0	1.15	A162	162.0	1.10
A38 (4L400)	40.0	0.20	A70 (4L720)	72.0	0.40	A103	198.0	1.31	A173	175.0	1.15
A39 (4L410)	41.0	0.20	A71 (4L730)	73.0	0.40	A104	199.0	1.31	A180	182.0	1.15
A40 (4L420)	42.0	0.20	A72 (4L740)	74.0	0.40	A105	212.0	1.35	A196	198.0	1.31
A41 (4L430)	43.0	0.20	A73 (4L750)	75.0	0.40	A106	223.0	1.40	A197	199.0	1.31
A42 (4L440)	44.0	0.20	A74 (4L760)	76.0	0.40	A107	258.0	1.70	A210	212.0	1.35
A43 (4L450)	45.0	0.30	A75 (4L770)	77.0	0.40	A108	260.0	1.75	A221	223.0	1.40
A44 (4L460)	46.0	0.30	A76 (4L780)	78.0	0.40	A109	78.0	0.40	A256	258.0	1.70
A45 (4L470)	47.0	0.30	A77 (4L790)	79.0	0.40	A110	79.0	0.40	A258	260.0	1.75
A46 (4L480)	48.0	0.30	A78 (4L800)	113.0	0.75	A111	113.0	0.75			

V-BELTS

"B" SECTION 0.66" TOP WIDTH x 0.41" THICKNESS x 40° ANGLE

• Note - For B Section B210 and under, add 3 inches for outside length - Example: B20 + 3 inches = 23" approximate outside length

Belt Number	Outside Length (in.)	Approx. Weight (lbs.)	Belt Number	Outside Length (in.)	Approx. Weight (lbs.)	Belt Number	Outside Length (in.)	Approx. Weight (lbs.)	Belt Number	Outside Length (in.)	Approx. Weight (lbs.)
B20	23.0	0.40	B63 (5L660)	66.0	0.70	B108	111.0	1.00	B173	176.0	1.50
B21 (5L240)	24.0	0.40	B64 (5L670)	67.0	0.70	B109	112.0	1.00	B175	178.0	1.50
B22 (5L250)	25.0	0.40	B65 (5L680)	68.0	0.70	B110	113.0	1.10	B177	180.0	1.50
B23 (5L260)	26.0	0.40	B66 (5L690)	69.0	0.70	B111	114.0	1.10	B180	183.0	1.50
B24 (5L270)	27.0	0.40	B67 (5L700)	70.0	0.70	B112	115.0	1.10	B182	185.0	1.50
B25 (5L280)	28.0	0.40	B68 (5L710)	71.0	0.70	B113	116.0	1.15	B184	187.0	1.50
B26 (5L290)	29.0	0.40	B69 (5L720)	72.0	0.70	B114	117.0	1.20	B187	190.0	1.70
B27 (5L300)	30.0	0.40	B70 (5L730)	73.0	0.70	B115	118.0	1.20	B188	191.0	1.80
B28 (5L310)	31.0	0.40	B71 (5L740)	74.0	0.70	B116	119.0	1.20	B190	193.0	1.90
B29 (5L320)	32.0	0.40	B72 (5L750)	75.0	0.70	B118	121.0	1.20	B192	195.0	2.00
B30 (5L330)	33.0	0.40	B73 (5L760)	76.0	0.70	B120	123.0	1.20	B195	198.0	2.00
B31 (5L340)	34.0	0.40	B74 (5L770)	77.0	0.70	B122	125.0	1.20	B197	200.0	2.00
B32 (5L350)	35.0	0.40	B75 (5L780)	78.0	0.70	B123	126.0	1.20	B204	207.0	2.00
B33 (5L360)	36.0	0.40	B76 (5L790)	79.0	0.70	B124	127.0	1.20	B205	208.0	2.00
B34 (5L370)	37.0	0.40	B77 (5L800)	80.0	0.80	B125	128.0	1.20	B210	213.0	2.00
B35 (5L380)	38.0	0.40	B78 (5L810)	81.0	0.80	B126	129.0	1.20	B215	220.0	2.10
B36 (5L390)	39.0	0.40	B79 (5L820)	82.0	0.80	B127	130.0	1.20	B221	226.0	2.25
B37 (5L400)	40.0	0.40	B80 (5L830)	83.0	0.80	B128	131.0	1.30	B223	228.0	2.25
B38 (5L410)	41.0	0.40	B81 (5L840)	84.0	0.80	B130	133.0	1.30	B224	229.0	2.30
B39 (5L420)	42.0	0.40	B82 (5L850)	85.0	0.80	B131	134.0	1.30	B225	230.0	2.30
B40 (5L430)	43.0	0.40	B83 (5L860)	86.0	0.80	B132	135.0	1.30	B228	233.0	2.30
B41 (5L440)	44.0	0.40	B84 (5L870)	87.0	0.80	B133	136.0	1.30	B229	234.0	2.30
B42 (5L450)	45.0	0.40	B85 (5L880)	88.0	0.80	B134	137.0	1.30	B234	239.0	2.30
B43 (5L460)	46.0	0.40	B86 (5L890)	89.0	0.80	B135	138.0	1.30	B237	242.0	2.30
B44 (5L470)	47.0	0.40	B87 (5L900)	90.0	0.80	B136	139.0	1.30	B240	245.0	2.30
B45 (5L480)	48.0	0.40	B88 (5L910)	91.0	0.80	B138	141.0	1.30	B248	253.0	2.30
B46 (5L490)	49.0	0.50	B89 (5L920)	92.0	0.80	B140	143.0	1.30	B253	258.0	2.30
B47 (5L500)	50.0	0.50	B90 (5L930)	93.0	0.90	B141	144.0	1.30	B255	260.0	2.30
B48 (5L510)	51.0	0.50	B91 (5L940)	94.0	0.90	B142	145.0	1.30	B259	264.0	2.30
B49 (5L520)	52.0	0.50	B92 (5L950)	95.0	0.90	B144	147.0	1.40	B265	270.0	2.30
B50 (5L530)	53.0	0.50	B93 (5L960)	96.0	0.90	B147	150.0	1.40	B270	275.0	2.30
B51 (5L540)	54.0	0.50	B94 (5L970)	97.0	0.90	B148	151.0	1.40	B276	281.0	2.70
B52 (5L550)	55.0	0.50	B95 (5L980)	98.0	0.90	B150	153.0	1.50	B285	290.0	2.70
B53 (5L560)	56.0	0.50	B96 (5L990)	99.0	0.90	B152	155.0	1.50	B292	297.0	2.70
B54 (5L570)	57.0	0.50	B97 (5L1000)	100.0	0.90	B153	156.0	1.50	B293	298.0	2.70
B55 (5L580)	58.0	0.60	B98 (5L1010)	101.0	0.90	B154	157.0	1.50	B300	305.0	2.70
B56 (5L590)	59.0	0.60	B99 (5L1020)	102.0	1.00	B156	159.0	1.50	B315	320.0	2.90
B57 (5L600)	60.0	0.60	B100	103.0	1.00	B157	160.0	1.50	B330	335.0	2.90
B58 (5L610)	61.0	0.60	B101	104.0	1.00	B158	161.0	1.50	B333	338.0	2.90
B59 (5L620)	62.0	0.60	B102	105.0	1.00	B162	165.0	1.50	B345	350.0	3.00
B60 (5L630)	63.0	0.60	B103	106.0	1.00	B163	166.0	1.50	B360	365.0	3.20
B61 (5L640)	64.0	0.70	B104	107.0	1.00	B165	168.0	1.50	B394	399.0	4.00
B62 (5L650)	65.0	0.70	B105	108.0	1.00	B168	171.0	1.50	B433	438.0	4.20
			B106	109.0	1.00	B170	173.0	1.50	B472	477.0	4.60
			B107	110.0	1.00						

"C" SECTION 0.88" TOP WIDTH x 0.53" THICKNESS x 40° ANGLE

• Note - For C Section C210 and under, add 4 inches for outside length - Example: C41 + 4 inches = 45" approximate outside length

Belt Number	Outside Length (in.)	Approx. Weight (lbs.)	Belt Number	Outside Length (in.)	Approx. Weight (lbs.)	Belt Number	Outside Length (in.)	Approx. Weight (lbs.)	Belt Number	Outside Length (in.)	Approx. Weight (lbs.)
C41	143.0	1.24	C81	85.0	1.30	C130	134.0	1.24	C200	204.0	3.50
C43	145.0	1.25	C83	87.0	1.30	C132	136.0	1.25	C202	206.0	3.60
C45	147.0	1.27	C85	89.0	1.40	C134	138.0	1.27	C204	208.0	3.60
C46	148.0	1.28	C86	90.0	1.40	C136	140.0	1.28	C207	211.0	3.65
C47	149.0	1.29	C87	91.0	1.40	C138	142.0	1.29	C208	212.0	3.65
C48	150.0	1.30	C88	92.0	1.40	C140	144.0	1.30	C210	214.0	3.70
C50	151.0	1.31	C90	94.0	1.40	C141	145.0	1.31	C220	226.0	3.70
C51	152.0	1.31	C92	96.0	1.40	C142	146.0	1.31	C225	231.0	4.40
C52	154.0	1.33	C93	97.0	1.40	C143	147.0	1.33	C228	234.0	4.40
C53	155.0	1.34	C94	98.0	1.50	C144	148.0	1.34	C238	244.0	4.80
C54	156.0	1.35	C96	100.0	1.50	C148	152.0	1.35	C240	246.0	4.80
C55	157.0	1.36	C97	101.0	1.80	C150	154.0	1.36	C245	251.0	5.00
C56	158.0	1.37	C98	102.0	1.80	C152	156.0	1.37	C246	252.0	5.00
C57	159.0	1.38	C99	103.0	1.80	C153	157.0	1.38	C248	254.0	5.00
C58	162.0	1.40	C100	104.0	1.90	C154	158.0	1.40	C255	261.0	5.00
C59	163.0	1.41	C101	105.0	1.90	C155	159.0	1.41	C270	276.0	5.40
C60	164.0	1.42	C102	106.0	1.90	C156	160.0	1.42	C276	282.0	5.40
C62	166.0	1.44	C103	107.0	1.90	C158	162.0	1.44	C280	286.0	5.50
C63	168.0	1.45	C104	108.0	1.90	C159	163.0	1.45	C285	291.0	5.60
C64	170.0	1.47	C105	109.0	1.90	C160	164.0	1.47	C297	303.0	5.60
C65	173.0	1.50	C106	110.0	1.90	C162	166.0	1.50	C300	306.0	5.60
C66	175.0	1.51	C108	112.0	1.90	C166	170.0	1.51	C303	309.0	5.60
C67	176.0	1.52	C109	113.0	1.90	C168	172.0	1.52	C314	320.0	5.60
C68	180.0	1.56	C110	114.0	1.90	C172	176.0	1.56	C315	321.0	5.60
C69	182.0	1.57	C112	116.0	2.00	C173	177.0	1.57	C330	336.0	5.70
C70	183.0	1.58	C115	119.0	2.00	C175	179.0	1.58	C345	351.0	6.60
C72	185.0	1.60	C116	120.0	2.00	C177	181.0	1.60	C360	366.0	7.00
C73	186.0	1.61	C118	122.0	2.00	C180	184.0	1.61	C390	396.0	7.40
C75	190.0	1.64	C120	124.0	2.10	C185	189.0	1.64	C420	426.0	7.80
C78	196.0	1.70	C124	128.0	2.20	C188	192.0	1.70	C480	486.0	7.90
C79	201.0	1.74	C126	130.0	2.25	C190	194.0	1.74			
C80	202.0	1.75	C128	132.0	2.30	C195	199.0	1.75			



WARNING: These products can expose you to chemicals including carbon black which is known in the state of California to cause cancer, birth defects or other reproductive harm. For more information visit www.P65WARNINGS.ca.gov

"D" SECTION 1.25" TOP WIDTH x 0.75" THICKNESS x 40° ANGLE

- Note - For D Section D210 and under, add 5 inches for outside length - Example: D90 + 5 inches = 95" approximate outside length

Belt Number	Outside Length (in.)	Approx. Weight (lbs.)	Belt Number	Outside Length (in.)	Approx. Weight (lbs.)	Belt Number	Outside Length (in.)	Approx. Weight (lbs.)	Belt Number	Outside Length (in.)	Approx. Weight (lbs.)
D90	95.0	3.40	D171	176.0	6.40	D270	278.0	10.00	D420	428.0	15.80
D105	110.0	4.00	D173	178.0	6.50	D285	293.0	10.70	D441	449.0	16.50
D115	120.0	4.30	D180	185.0	6.80	D300	308.0	11.20	D450	458.0	16.95
D120	125.0	4.50	D195	200.0	7.30	D315	323.0	11.80	D480	488.0	18.10
D128	133.0	4.80	D205	210.0	7.90	D330	338.0	12.40	D540	548.0	20.20
D132	137.0	5.00	D210	215.0	8.40	D345	353.0	12.60	D600	608.0	22.40
D136	141.0	5.20	D225	233.0	8.40	D355	363.0	13.00	D660	668.0	24.80
D144	149.0	5.40	D240	248.0	9.00	D360	368.0	13.50			
D158	163.0	6.00	D248	256.0	9.00	D390	398.0	14.60			
D162	167.0	6.10	D255	263.0	9.50	D394	402.0	14.80			

"E" SECTION 1.5" TOP WIDTH x 1" THICKNESS x 40° ANGLE

- Note - For E Section, add 6 inches for outside length - Example: E144 + 6 inches = 150" approximate outside length

Belt Number	Outside Length (in.)	Approx. Weight (lbs.)	Belt Number	Outside Length (in.)	Approx. Weight (lbs.)	Belt Number	Outside Length (in.)	Approx. Weight (lbs.)	Belt Number	Outside Length (in.)	Approx. Weight (lbs.)
E144	150.0	9.30	E225	231.0	13.00	E310	316.0	17.60	E420	426.0	23.80
E180	186.0	9.30	E240	246.0	13.50	E330	336.0	18.80	E441	447.0	25.00
E195	201.0	10.00	E270	276.0	15.30	E360	366.0	20.40	E460	466.0	26.00
E210	216.0	12.00	E300	306.0	17.00	E390	396.0	22.10	E480	486.0	28.00

CENTRIFUGAL (PTO) REPLACEMENT BELTS

for: Ace Centrifugal Pump — Model PTOC/H600-10, 1000-10, 600-10B
Model CPK Centrifugal Sprayer Pump

Belt Number	Description	Fits Model Number
BAC-28-8	Poly-V belt, 8 Groove	PTOC-540, 600, 600B, 600D
AC-28-8M	Poly-V belt, 8 Groove	PTOC-1000, 1000B
BAC-28-10	Poly-V belt, 10 Groove	PTOC-600-10, 600-10B
BAC-28-10M	Poly-V belt, 10 Groove	PTOC-1000-10, 1000-10B
BAC-28-10-150	Poly-V belt, 10 Groove	PTOC RPM, 1000 RPM
BAC-28-10M-150	Poly-V belt, 10 Groove	PTOC PPMB, 1000 RPMB
CPK-28-2	Polyflex, set 2 ea.	CPK Sprayer Pump, 3450 RPM
FMK-28-2M	Neoflex, set 2ea.	1000 RPM, Front PT

for: Hypro (belt drive) Centrifugal Pump — Model 9401C (600RPM PTO)
Model 9401C-1000 (1000 RPM PTO)

Belt Number	Description	Fits Model Number
540J12	Poly-V belt, 12 Groove	9403-540S
3100-0005	Poly-V belt, 12 Groove	540 RPM
3100-0006	Poly-V belt, 12 Groove	1000 RPM
3103-0004	Polyflex, set 2 ea.	9200-540 RPM
3103-0005	Polyflex, set 2 ea.	9200-1000 RPM
3103-0009 (ST876)	Timing Belt, 345L100	9401-6000 RPM
3103-0010 (ST686)	Timing Belt, 270L100	9401-1000 RPM



WARNING: These products can expose you to chemicals including carbon black which is known in the state of California to cause cancer, birth defects or other reproductive harm. For more information visit www.P65WARNINGS.ca.gov

V-BELTS

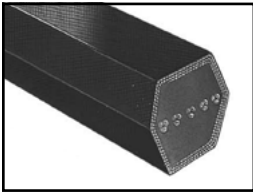

DOUBLE-V (HEXAGONAL) CLASSICAL BELTS - AA, BB, CC Cross Sections

Specially designed for serpentine and reversing drives, Double V-Belts transmit power from both sides of the belt. Polyester cords and cotton/polyester cover provide maximum strength and length stability with minimum stretch. These belts conform to ARPM Engineering Standard IP-21. Double V-Belts are available in three standard ARPM sections - AA, BB and CC - and

in lengths up to 540 inches. They are specified by belt section letters and a Standard Length Designation that is equivalent to the length of single "V" profile belts - **Example: AA49**

CC Section - Dry can belts available on request. These are used in drying can applications in the textile industry.

Features & Benefits

- **Polyester Tensile Member** - Maximum strength, minimum stretch
- **Dual Cross-Section Construction** - Flexibility in design; delivers power from both sides of the belt
- **Center Cordline Construction** - Increased flexibility on reverse bend or serpentine drives; longer life than standard belts

Construction

Compound - Natural Rubber/SBR

Cord - Polyester

Cover - Cotton/Polyester blend

Applications - General Industry, Lawn & Garden, Agriculture, Textile, Material Sorting Equipment

Engineering Standards - Conforms to ARPM standard IP-21

Recommended Pulleys - Use pulleys made to ARPM IP-20 for the respective single V-Belt

Note - These belts do not use the same nomenclature as Agricultural belts. Refer to Jason/Megadyne Engineering for length conversions

PART NUMBER DESIGNATION

AA49

AA = Belt Center Width = 0.5"

49 = Inside length in inches = 49.9"

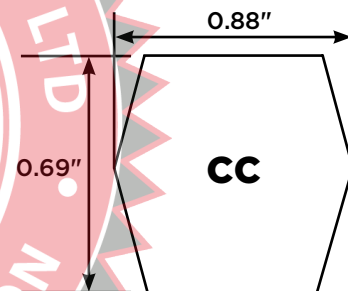
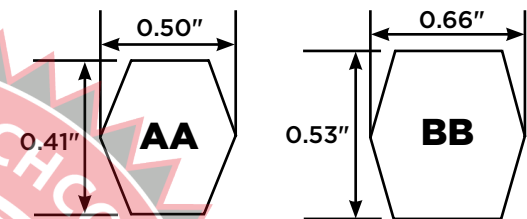

"AA" SECTION 0.5" WIDE, 0.41" THICK

Belt Number	Inside Length (in.)	Approx. Weight (lbs.)	Belt Number	Inside Length (in.)	Approx. Weight (lbs.)	Belt Number	Inside Length (in.)	Approx. Weight (lbs.)	Belt Number	Inside Length (in.)	Approx. Weight (lbs.)
AA49	49.9	0.50	AA75	75.9	0.60	AA96	96.9	1.00	AA145	145.9	1.40
AA51	51.9	0.50	AA78	78.9	0.75	AA98	98.9	1.00	AA148	148.9	1.50
AA55	55.9	0.50	AA80	80.9	0.80	AA100	100.9	1.00	AA155	155.9	1.50
AA58	58.9	0.50	AA83	83.9	0.80	AA105	105.9	1.00	AA194	194.9	1.80
AA60	60.9	0.50	AA85	85.9	0.80	AA112	112.9	1.20	AA240	240.9	2.40
AA63	63.9	0.60	AA88	88.9	0.80	AA120	120.9	1.20			
AA68	68.9	0.60	AA90	90.9	0.80	AA128	128.9	1.30			
AA73	73.9	0.60	AA93	93.9	1.00	AA130	130.9	1.30			

"BB" SECTION 0.66" WIDE, 0.53" THICK

Belt Number	Inside Length (in.)	Approx. Weight (lbs.)	Belt Number	Inside Length (in.)	Approx. Weight (lbs.)	Belt Number	Inside Length (in.)	Approx. Weight (lbs.)	Belt Number	Inside Length (in.)	Approx. Weight (lbs.)
BB43	44.3	0.60	BB90	91.3	1.10	BB120	121.3	1.50	BB180	181.3	2.20
BB45	46.3	0.64	BB92	93.3	1.20	BB124	125.3	1.50	BB182	183.3	2.30
BB50	51.3	0.70	BB93	94.3	1.20	BB127	128.3	1.55	BB185	186.3	2.30
BB51	52.3	0.70	BB94	95.3	1.20	BB128	129.3	1.60	BB187	188.3	2.40
BB54	55.3	0.85	BB95	96.3	1.20	BB129	130.3	1.70	BB190	191.3	2.40
BB55	56.3	0.90	BB96	97.3	1.20	BB130	131.3	1.70	BB195	196.3	2.40
BB60	61.3	1.00	BB97	98.3	1.20	BB133	134.3	1.75	BB210	211.3	2.60
BB62	63.3	1.00	BB100	101.3	1.25	BB136	137.3	1.80	BB214	215.3	2.65
BB68	69.3	1.00	BB102	103.3	1.30	BB140	141.3	1.80	BB215	216.3	2.66
BB70	71.3	1.00	BB103	104.3	1.30	BB144	145.3	1.80	BB225	226.3	2.80
BB71	72.3	1.00	BB104	105.3	1.30	BB148	149.3	1.90	BB228	229.3	2.90
BB72	73.3	1.00	BB105	106.3	1.30	BB155	156.3	2.00	BB234	235.3	2.90
BB73	74.3	1.00	BB107	108.3	1.30	BB158	159.3	2.00	BB240	241.3	2.90
BB74	75.3	1.00	BB108	109.3	1.30	BB161	162.3	2.00	BB255	256.3	3.10
BB75	76.3	1.00	BB111	112.3	1.30	BB162	163.3	2.10	BB270	271.3	3.30
BB76	77.3	1.00	BB112	113.3	1.40	BB168	169.3	2.10	BB278	279.3	3.70
BB77	78.3	1.00	BB114	115.3	1.40	BB170	171.3	2.10	BB300	301.3	3.70
BB81	82.3	1.10	BB115	116.3	1.45	BB172	173.3	2.10	BB360	361.3	4.60
BB85	86.3	1.10	BB116	117.3	1.50	BB173	174.3	2.10			
BB87	88.3	1.10	BB118	119.3	1.50	BB175	176.3	2.10			

"CC" SECTION 0.88" WIDE, 0.69" THICK

Belt Number	Inside Length (in.)	Approx. Weight (lbs.)	Belt Number	Inside Length (in.)	Approx. Weight (lbs.)	Belt Number	Inside Length (in.)	Approx. Weight (lbs.)	Belt Number	Inside Length (in.)	Approx. Weight (lbs.)
CC75	77.1	1.70	CC119	121.1	2.60	CC173	175.1	3.80	CC240	242.1	5.20
CC81	83.1	1.80	CC120	122.1	2.70	CC174	176.1	3.80	CC270	272.1	5.90
CC85	87.1	1.90	CC128	130.1	2.90	CC178	180.1	4.00	CC300	302.1	6.50
CC90	92.1	2.00	CC140	142.1	3.10	CC180	182.1	4.00	CC330	332.1	7.20
CC96	98.1	2.20	CC144	146.1	3.20	CC195	197.1	4.60	CC360	362.1	7.80
CC105	107.1	2.40	CC154	156.1	3.40	CC210	212.1	4.70	CC390	392.1	8.50
CC112	114.1	2.50	CC158	160.1	3.50	CC225	227.1	4.90	CC420	422.1	9.10
CC118	120.1	2.60	CC162	164.1	3.80	CC234	236.1	5.10	CC780	782.1	14.90

DOUBLE-V CLASSICAL BELTS FOR POULTRY INDUSTRY



Note: "N" suffix on belt number denotes double-notch construction. Contact Jason for availability of additional sizes.

Used on equipment in the poultry industry for the de-feathering process, the table below lists popular sizes of Jason Double-V Classical Belts which have proven themselves in this harsh environment. Where a suffix of N is seen at the end of the belt number (Example: BB158N), belts are double-notched for extra flexibility.

Belt Number	Inside Length (in.)	Approx. Weight (lbs.)	Construction
AA128	128.9	1.30	Standard
AA148	148.9	1.50	Standard
BB155	156.3	2.00	Standard
BB155N	156.3	2.00	Double Notched
BB158	159.3	2.00	Standard
BB158N	159.3	2.00	Double Notched
BB172N	173.3	2.10	Double Notched
BB185	186.3	2.30	Standard

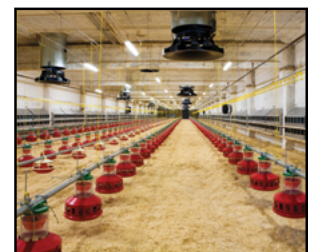

WARNING: These products can expose you to chemicals including carbon black which is known in the state of California to cause cancer, birth defects or other reproductive harm. For more information visit www.P65WARNINGS.ca.gov

V-BELTS



UNIMATCH® COGGED RAW EDGE CLASSICAL V-BELTS - AX, BX, CX Oil & Heat Resistant/Static Dissipating

Megadyne V-Belts in raw edge, cogged construction are ideally suited to high-speed compact drives. These belts all have the UniMatch feature ensuring belts of matched length when used on drives requiring the use of multiple, or a set of belts.

Cogged Raw Edge V-Belts are designated by a letter indicating belt section, followed by "X" which signifies cogged, raw edge construction that has greater power capacity than standard wrapped construction.

WARNING: This product can expose you to chemicals including carbon black, which is known to the State of California to cause cancer or birth defects or other reproductive harm. For more information visit www.P65WARNINGS.ca.gov

PART NUMBER DESIGNATION

AX22

- A** = 0.5" Width x 0.31" Thickness
- X** = Raw edge sidewalls, cogged construction
- 22** = Inside length in inches

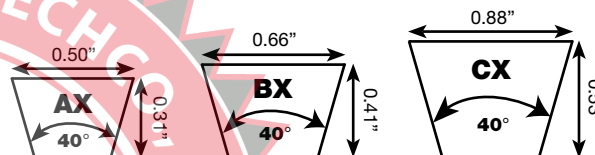

Features & Benefits

- **Raw Edge Sidewalls** - Eliminates slippage and increases efficiency versus wrapped V-Belts and saves energy
- **UniMatch Construction** - Consistent performance in multiple V-Belt drives and ensures all belts of the same size measure within ARPM matching limits
- **Oil & Heat Resistant** - Better than standard belts in oily environments (occasional splash) and higher ambient temperatures

Construction

Compound - Chloroprene

Cord - Polyester

Top Fabric - Cotton/Polyester blend

Applications - General Industry, HVAC Equipment, Lawn & Garden, Agriculture

Engineering Standards - Conforms to ARPM standard IP-20

Temperature Range - -22°F/+194° (-30°C/+90°C)

Recommended Pulleys - Use pulleys made to ARPM standards

**UNIMATCH® COGGED RAW EDGE CLASSICAL
AX, BX, CX**

AVAILABLE SIZES

AX		
Belt Number	Outside Length (inch)	Approx. Weight (lbs.)
AX22	24.0	0.17
AX23	25.0	0.17
AX24	26.0	0.17
AX25	27.0	0.18
AX26	28.0	0.18
AX27	29.0	0.18
AX28	30.0	0.19
AX29	31.0	0.20
AX30	32.0	0.20
AX31	33.0	0.21
AX32	34.0	0.21
AX33	35.0	0.22
AX34	36.0	0.23
AX35	37.0	0.24
AX36	38.0	0.24
AX37	39.0	0.25
AX38	40.0	0.26
AX39	41.0	0.26
AX40	42.0	0.26
AX41	43.0	0.27
AX42	44.0	0.28
AX43	45.0	0.29
AX44	46.0	0.30
AX45	47.0	0.31
AX46	48.0	0.31
AX47	49.0	0.31
AX48	50.0	0.32
AX49	51.0	0.33
AX50	52.0	0.33
AX51	53.0	0.34
AX52	54.0	0.35
AX53	55.0	0.35
AX54	56.0	0.36
AX55	57.0	0.36
AX56	58.0	0.37
AX57	59.0	0.37
AX58	60.0	0.38
AX59	61.0	0.40
AX60	62.0	0.40
AX61	63.0	0.40
AX62	64.0	0.41
AX63	65.0	0.41
AX64	66.0	0.42
AX65	67.0	0.43
AX66	68.0	0.43
AX67	69.0	0.44
AX68	70.0	0.45
AX69	71.0	0.46
AX70	72.0	0.46
AX71	73.0	0.47
AX72	74.0	0.48
AX73	75.0	0.48
AX75	77.0	0.49
AX76	78.0	0.50
AX78	80.0	0.51
AX80	82.0	0.52

AX/BX		
Belt Number	Outside Length (inch)	Approx. Weight (lbs.)
AX80	82.0	0.52
AX84	86.0	0.54
AX85	87.0	0.55
AX86	88.0	0.56
AX90	92.0	0.59
AX92	94.0	0.61
AX96	98.0	0.62
AX105	107.0	0.68
AX108	108.0	0.70
AX110	112.0	0.71
AX112	114.0	0.73
AX120	122.0	0.74
AX128	130.0	0.78
AX136	138.0	0.82
BX		
BX30	33.0	0.38
BX31	34.0	0.39
BX32	35.0	0.39
BX33	36.0	0.39
BX34	37.0	0.39
BX35	38.0	0.40
BX36	39.0	0.42
BX37	40.0	0.43
BX38	41.0	0.43
BX39	42.0	0.45
BX40	43.0	0.46
BX41	44.0	0.47
BX42	45.0	0.48
BX43	46.0	0.49
BX44	47.0	0.50
BX45	48.0	0.51
BX46	49.0	0.52
BX47	50.0	0.53
BX48	51.0	0.54
BX49	52.0	0.55
BX50	53.0	0.56
BX51	54.0	0.57
BX52	55.0	0.58
BX53	56.0	0.59
BX54	57.0	0.60
BX55	58.0	0.61
BX56	59.0	0.62
BX57	60.0	0.63
BX58	61.0	0.64
BX59	62.0	0.65
BX60	63.0	0.66
BX61	64.0	0.67
BX62	65.0	0.68
BX63	66.0	0.69
BX64	67.0	0.70
BX65	68.0	0.71
BX66	69.0	0.72
BX67	70.0	0.73
BX68	71.0	0.74
BX69	72.0	0.75
BX70	73.0	0.76

BX		
Belt Number	Outside Length (inch)	Approx. Weight (lbs.)
BX71	74.0	0.78
BX72	75.0	0.79
BX73	76.0	0.80
BX74	77.0	0.81
BX75	78.0	0.82
BX76	79.0	0.83
BX77	80.0	0.85
BX78	81.0	0.86
BX79	82.0	0.87
BX80	83.0	0.88
BX81	84.0	0.89
BX82	85.0	0.90
BX83	86.0	0.91
BX84	87.0	0.92
BX85	88.0	0.93
BX86	89.0	0.93
BX87	90.0	0.93
BX88	91.0	0.95
BX89	92.0	0.96
BX90	93.0	0.98
BX91	94.0	0.99
BX92	95.0	1.00
BX93	96.0	1.01
BX94	97.0	1.02
BX95	98.0	1.03
BX96	99.0	1.05
BX97	100.0	1.06
BX98	101.0	1.07
BX99	102.0	1.08
BX100	103.0	1.09
BX103	106.0	1.12
BX105	108.0	1.14
BX108	111.0	1.17
BX112	115.0	1.22
BX113	116.0	1.22
BX115	118.0	1.25
BX116	119.0	1.26
BX120	123.0	1.30
BX124	127.0	1.30
BX128	131.0	1.30
BX133	136.0	1.34
BX136	139.0	1.37
BX140	143.0	1.40
BX144	147.0	1.45
BX150	153.0	1.51
BX158	161.0	1.59
BX162	165.0	1.63
BX173	176.0	1.74
BX180	183.0	1.81
BX195	198.0	1.96
BX210	213.0	2.10
BX225	227.0	2.30
BX240	242.0	2.36
BX255	257.0	2.50
BX270	272.0	2.64

CX		
Belt Number	Outside Length (inch)	Approx. Weight (lbs.)
CX51	55.0	1.07
CX60	64.0	1.24
CX68	72.0	1.39
CX71	75.0	1.45
CX73	77.0	1.49
CX74	78.0	1.51
CX75	79.0	1.53
CX76	80.0	1.55
CX77	81.0	1.57
CX78	82.0	1.59
CX79	83.0	1.61
CX80	84.0	1.63
CX81	85.0	1.64
CX82	86.0	1.67
CX83	87.0	1.69
CX84	88.0	1.71
CX85	89.0	1.72
CX86	90.0	1.75
CX87	91.0	1.79
CX88	92.0	1.79
CX89	93.0	1.81
CX90	94.0	1.81
CX96	100.0	1.93
CX105	109.0	2.10
CX109	113.0	2.18
CX112	116.0	2.24
CX115	119.0	2.29
CX120	124.0	2.39
CX123	127.0	2.40
CX128	132.0	2.42
CX133	137.0	2.47
CX136	140.0	2.49
CX144	148.0	2.63
CX150	154.0	2.75
CX158	162.0	2.90
CX162	166.0	2.95
CX173	177.0	3.15
CX180	184.0	3.27
CX187	191.0	3.40
CX190	194.0	3.46
CX195	199.0	3.55
CX210	214.0	3.77
CX240	243.0	4.30
CX255	258.0	4.58
CX270	273.0	4.85

 **WARNING:** This product can expose you to chemicals including carbon black, which is known to the State of California to cause cancer or birth defects or other reproductive harm. For more information visit www.P65WARNINGS.ca.gov

V-BELTS

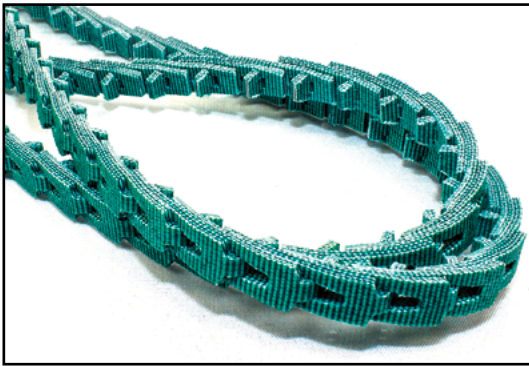

ACCU-LINK® DETACHABLE TAB LINK TYPE V-BELT The Ideal V-Belt Alternative!

Accu-Link is an alternative to conventional rubber belts in many applications. Made endless with a single twist, an open length of belt can be wrapped around pulleys in hard-to-fit applications yielding fast belt replacement. Additionally, Accu-Link's high strength polyester fabric link design offers high tensile strength and reduces vibration. Accu-Link's urethane impregnation offers terrific oil and wear resistance.

Features & Benefits

- **Durable Urethane Coating** - Increased life and durability
- **Rugged Polyester Fabric** - Strength and longer life; maximum horsepower
- **Assemble To Any Length** - Reduces inventory
- **Easy "No Tools" Assembly** - Assembles by hand
- **Chemical/High-Temp Resistance** - Dependable in harsh environments
- **Link Construction** - Rolls onto drive pulleys like chain - no cords to break.
- **Smooth Operation** - Reduced vibration over conventional V-Belts
- **Versatile** - Can be used in any industry, hundreds of applications
- **Horsepower Capacity** - Power ratings equal to conventional V-Belts
- **Interchangeability** - Uses existing standard pulleys

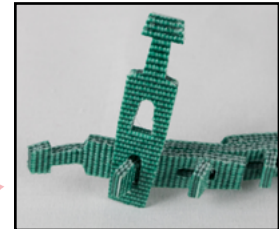
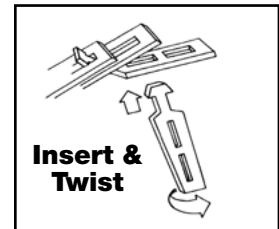

Construction

Rugged polyester fabric impregnated with premium urethane coating

Applications - For use in applications where it's difficult to install an endless belt, avoiding costly labor-intensive machine dis-assembly. Ideal for use on mobile service vehicles where carrying a large inventory of belts is not practical. Can be used either as singles or on multiple belt drives. Widely used in poultry, HVAC, agriculture and general industry.

Engineering Standards - None (No engineering standard exists for link-type belting)

Recommended Pulleys - Use pulleys made to ARPM standards

Temperature Range - -13°F/+176°F (-25°C/+80°C)

Belt Type/Section	Part Number	Length (feet)	Weight Per Foot (lbs.)	Packaging
3L	3L-LINK-5	5	0.50	5 ft. in one sleeve
	3L-LINK-25	25	0.50	25 ft. in one carton
	3L-LINK-100	100	0.50	100 ft. in one carton
A	A-LINK-5	5	0.60	5 ft. in one sleeve
	A-LINK-25	25	0.60	25 ft. in one carton
	A-LINK-100	100	0.60	100 ft. in one carton
B	B-LINK-6	6	0.90	6 ft. in one sleeve
	B-LINK-25	25	0.90	25 ft. in one carton
	B-LINK-100	100	0.90	100 ft. in one carton
C	C-LINK-25	25	1.70	25 ft. in one carton

V-BELT TENSIONING INSTRUCTIONS

V-Belt tensioning adjustment can be made using a tension gauge or other type spring scale, using the following procedure. After seating the belts in the groove and adjusting center distance so as to take up slack in the belts, further increase the tension until only a slight bow on the slack side is apparent while the drive is operating under load. Stop the drive and, using the gauge, measure the force necessary to depress one of the center belts 1/64-inch for every inch of belt span (see sketch below). For example, a deflection for a 50-inch belt span is 50/64ths, or 25/32-inch. The amount of force required to deflect the belt should compare with the deflection forces noted in the chart below. Also notice for V-Belts the deflection forces vary from the initial “run-in” values, which are greater (reflecting higher run-in tensioning) to the “normal” values for after the run-in period.

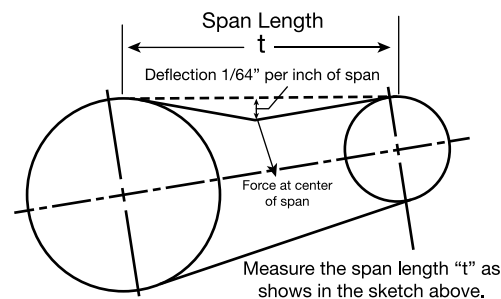

COMMON V-BELT TROUBLESHOOTING

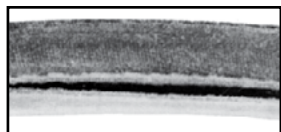

Exposure to Oil & Grease

Cause: Belt swelling, exterior softness and bottom envelope seam to open/split.
Remedy: Splash guards, don't over lubricate, clean belts/sheaves.



Weathering or “Crazing”

Cause: Belt drive elements, as well as aggravation by small sheaves.
Remedy: Check tension, provide drive protection and replace belt(s)

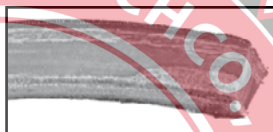

Worn Side Pattern

Cause: Worn or misaligned sheaves.
Remedy: Retension drive to stop slipping, realign sheaves (replace if needed) replace belt if incorrect size.

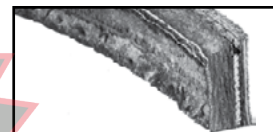

Oil Deterioration

Cause: Rubber softened by excessive oil exposure, causing deterioration.
Remedy: Splash guards to protect drive against oil.

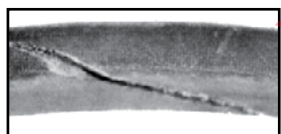

Cut Bottom & Sidewall

Cause: Belt being pried over sheave during installation, as cut above indicates.
Remedy: Use proper length belts and tension properly when installing.

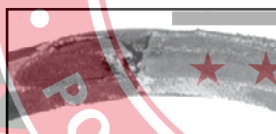

Severe Localized Wear

Cause: Spin burn caused by a frozen or locked drive sheave not able to turn freely.
Remedy: Determine that drive components turn freely and, if necessary, tighten belt.



Cover Fabric Rupture

Cause: Fabric cover ruptured during installation due to belt being pried over belt sheave.
Remedy: Proper installation of belts.

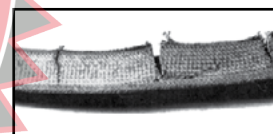

Base Cracking

Cause: Loose tensioning. Belt slippage causes heat build-up and gradual undercord hardening.
Remedy: New belt. Proper tensioning.

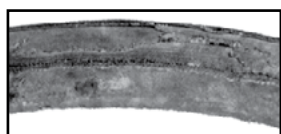

Rough Sheave Sidewalls

Cause: Constant slippage due to belt being misaligned on worn sheaves.
Remedy: Use correct belt size, Align or replace sheaves.



Broken Belt

Cause: Rough sheaves and dust build-up can both cause belt failure and severe envelope wear.
Remedy: Shield the drive



Distorted Belt

Cause: Distortion caused by broken cords or adhesion breakdown.
Remedy: Avoid prying on belts. Check sheaves for recommended diameters.

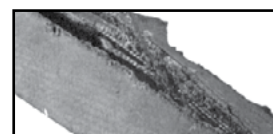

Ply Separation

Cause: Split along pitch line indicating belt ran on too small diameter of sheave.
Remedy: Install a (x) cogged type belt.

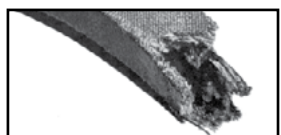

Snub Break

Cause: Cover wear indicates slippage and clean break reveals sudden snap due to non-proper drive tensioning
Remedy: Maintain proper drive tension

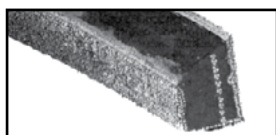

Abrasion

Cause: Sidewall wear a result of foreign material and rust in sheaves. Belt dropped to bottom of sheave groove.
Remedy: Dust guards to prevent abrasion.

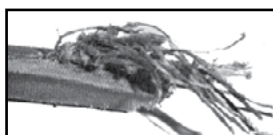

Ruptured Belt

Cause: Ruptured cords in the plies, caused by high shock load or foreign object between belt and sheave groove.



Slip Burn

Cause: Belt slipping under starting or stalling load.
Remedy: Replace belt and tighten drives until slipping stops.

OEM REPLACEMENT BELTS

Jason produces OEM equivalent belts using OEM specifications. These belts feature special construction or sizes not accommodated in our universal MXV™ line-up.

OEM	Part No.	Also Replaces	Description
AYP	106729		38", 10 & 11 HP Front Engine
AYP	130969	108310	Lawn Tractor belt - fits most 12, 12 1/2 and 14 Horsepower (Hp) AYP, Bernard, Husqvarna, Craftsman Rally 42 inch cut front engine lawn tractors.
AYP	131264		Fits Husqvarna, Weedeater 10-13 HP 36 inch deck front engine machines, AYP 36 inch cut side discharge narrow chassis, the early 36 inch riding lawn tractor lawn mower.
AYP	138255	130801, 160855	42" and 50" Decks with 25HP Kohler engine.
AYP	140294		Lawn Tractor Belt fits models of 18 to 21HP AYP, Bernard, Husqvarna, Craftsman 42 inch, 44 inch; deck side discharge.
AYP	144200	104778, 105364, 105380, 121979	AYP Craftsman lawn tractor belt fits most models of AYP, Bernard, Husqvarna, Craftsman Lawn Tractors 42 inch cut. Fits models with side discharge AYP 42 inch cut decks with double idler pulley HUSQVARNA YTH 150.
AYP	144959		Lawn Tractor Belt fits most models of AYP, Bernard, Husqvarna Rally and Craftsman 42 inch & 46 inch deck intermediate belt.
AYP	174368		Husqvarna 48 inch Primary deck belt for use on Husqvarna lawn tractor/ride on mowers models: HAU18H48A, YTH1848XPA, YTH1848XPB, YTH1848XPC, YTH2049A. Also fits Craftsman DYT 4000 24 HP 48 inch cut side discharge model 917.277620. This belt goes from engine to deck NOT round the spindles. Lawn Mower Belt Replaces (OEM): AYP 174368 HUSQVARNA 532 17 43-68 POULAN PP13007 Fits Models: HUSQVARNA YTH1848XP and YTH1848XPF, 48" cut decks Poulan Pro DPR22448STA, DPR22H48STB, DPR22H48STC & PR24PH48STA Application: Primary Deck Length: 90" Width: 5/8"
AYP	180214		AYP Lawn Tractor/ ride on mower deck belt - fits most models of AYP, Husqvarna, Craftsman, Rally 38 inch side discharge models (large chassis) with 5 star blade, generally before 2006 models.
AYP	180215	180215	AYP Lawn Tractor / ride on mower cutter deck mower belt fits most models of 16 to 21 HP AYP, Husqvarna Craftsman McCulloch fitted with 42 inch side discharge mower deck fitted with standard hi-lift or mulching mower blades.
AYP	180217	180217, 165555	AYP Craftsman hexagonal lawn tractor/ride on mower cutter deck belt to fit models of 36 inch rear discharge, AYP, Craftsman, Husqvarna, & McCulloch, both manual & hydrostatic transmission.
AYP	180808	PP13008	Replacement AYP / Husqvarna McCulloch lawn tractor ride on mower belt, 48 inch secondary deck belt to fit Husqvarna YTH1848XP & YTH1848XPF.
AYP	402009	402009, 169178	AYP, Husqvarna Hexagonal belt fits 42 inch rear eject riding tractor mowers with rear collector (not side tube), Craftsman, Rally, Husqvarna, McCulloch.
BOBCAT/ RANSOMES	38249		Traction Wheel Drive - Dual Rib
BOBCAT/ RANSOMES	38523		Traction Wheel Drive - Dual Rib
CASTEL GARDEN	35065600/0		Castel Garden TC102
CASTEL GARDEN	35065601/0		Castel Garden TC122
MTD	754-0280	954-0280A	Primary Drive Belt (From the Engine Pulley to the Variable Speed Pulley) on most 38" & 42" Riding Mowers.
MTD	754-0281	954-0281	Secondary Drive Belt (From Variable Speed Pulley to transaxle) on most 38" & 42" Riding Mowers
MTD	754-0329	954-0329	38", Engine to Deck
MTD	754-0346	954-0346	Self - Propelled, 462R 479R
MTD	754-0349	954-0349	46", Deck Drive
MTD	754-0350	954-0350	46" deep deck for 800 Series Garden Tractor, except Auto Drive models 1999 & after.
MTD	754-0358	140-180	Variable speed pulley to transaxle on most 46" riding mowers.



WARNING: These products can expose you to chemicals including carbon black which is known in the state of California to cause cancer, birth defects or other reproductive harm. For more information visit www.P65WARNINGS.ca.gov

OEM	Part No.	Also Replaces	Description
MTD	754-0362	820-849	Variable speed pulley to transmission on 800 series 2-speed garden tractor 1996 & prior.
MTD	754-0363	954-0363	Deck Belt, Fits 36" & 38" deep decks on 400 Series Riders & 50" deep decks on 800 Series Garden Tractor.
MTD	754-0364	954-0364	36" & 38" deep decks on 400 Series Riders & 50" deep decks on 800 Series Garden Tractor (1989 - 1998)
MTD	754-0367		Snow Blower Auger
MTD	754-0370	954-0370	Variable Speed Pulley to Transmission Pulley on 600 series lawn tractors 1990 & after.
MTD	754-0371	954-0371A	Deck Belt, Fits all MTD 42" deep deck 600 Series Lawn Tractors, except Auto Drive models 1999 & after.
MTD	754-0433	954-0433	38" Deck, side discharge
MTD	754-0434	954-0434	Engine to transmission
MTD	754-0438	954-0438	Tiller transmission to engine
MTD	754-0439	954-0439	46" deep deck 600 series lawn tractor, (except auto drive step thru frame models 1999 & after).
MTD	754-0440	954-0440	46" deep deck 600 series lawn tractor, (except auto drive step thru frame models 1999 & after).
MTD	754-0441	954-0441	Engine to Transmission on 600 series hydrostatic MTD lawn tractors, 2000 & prior.
MTD	754-0443A	954-0443A, 754-0329	38" Cut 800 Series Mowers, covered deck belt.
MTD	754-0444	954-0444	Variable Speed Pulley to Transmission Pulley
MTD	754-0453	954-0453	27.5" Deck, Variable Speed Pulley to Transmission Pulley
MTD	754-0461	954-0461	Transmission to Engine
MTD	754-0465	954-0465	Engine to Transmission
MTD	754-0468	954-0468	42", 46" Deck, variable speed to transmission
MTD	754-0474	954-0474	46" deep deck, deck pulley to lower engine pulley on auto drive step thru frame lawn tractors 1999 & after, and MTD/Yard-Man Revolution 2001 & after.
MTD	754-0475	954-0475	50" Deck to lower Engine
MTD	754-0476	954-0476	46" Deck pulley to lower engine pulley on auto drive step thru frame garden tractors 1999 & after.
MURRAY	37X43		36" decks, rear and side discharge uniframe
MURRAY	37X56		45" deck, garden tractor
MURRAY	37X62	37X62MA	Fits 40" cut LT Tractors, new models since 1989 with side discharge.
MURRAY	37X63	037X63MA	Fits 38" cut, new models since 1989.
MURRAY	37X64	037X64MA	Motion Drive 21" Aerovac
MURRAY	37X65	037X65MA	25" & 30" cut, rear engine riders with transaxle. 1990 and Newer.
MURRAY	37X66		46" cut, light rail frame decks 1990 and newer. Also fits Scotts.
MURRAY	37X69		46" engine to deck
MURRAY	37X86	037X86MA	38" cut, light rail frame
MURRAY	37X88	037X88MA	42" cut, Hydro Tractor Blade drive belt
SIMPLICITY	1668066		42" Deck belt
SIMPLICITY	1703466		48" Deck belt
SNAPPER	1-2354		V21 Trans, self propelled mower
SNAPPER	1-2508		V21, 3.5/4.0 HP Engine



WARNING: These products can expose you to chemicals including carbon black which is known in the state of California to cause cancer, birth defects or other reproductive harm. For more information visit www.P65WARNINGS.ca.gov

CROSS-REFERENCE - LAWN & GARDEN

LAWN AND GARDEN EQUIPMENT PART NUMBERS

NOTE: FHP Belt may be upgraded to the MXV Belt, however the FHP Belt SHOULD NOT be substituted for the MXV Belt

Alphabetical sequence by manufacturer

OEM #	Belt No.	OEM #	Belt No.	OEM #	Belt No.	OEM #	Belt No.	OEM #	Belt No.
AIRCAP		1601239	MXV3-340	2029748	MXV4-340	72073	MXV3-250	5070A22	MXV5-560
538	MXV3-310	1601405	MXV4-400	2029789	MXV4-340	72074	MXV3-340	5163P1	MXV4-310
644	MXV3-350	1601524	MXV4-780	2029828	MXV3-370	72076	MXV4-350	51653P1	MXV4-310
10661	MXV4-400	1601672	MXV4-610	2029829	MXV4-350	72078	MXV4-770	A408	MXV5-710
10713	MXV4-320	1601695	MXV4-430	2087648	MXV4-720	72083	MXV4-360	A409	MXV5-580
10717	MXV3-300	1602157	MXV4-730	2087732	MXV4-780	72084	MXV3-270	M475	MXV5-300
10720	MXV5-740	1602969	MXV4-480	2087759	MXV4-660	72085	MXV3-290	AYP	
17522	MXV4-510	1603075	MXV4-930	2087778	MXV4-660	72086	MXV4-400	383	MXV4-240
16301	MXV4-310	1604406	MXV4-830	2087836	MXV4-740	72089	MXV4-360	708	MXV5-380
754240	MXV5-380	1605816	MXV4-840	2087883	MXV3-340	72093	MXV4-310	992	MXV4-230
754241	MXV5-350	1607051	MXV4-700	ARIENS/ GRAVELY		72095	MXV4-460	1060	MXV4-1080
754244	MXV4-400	1607812	MXV4-820	3088	MXV3-350	72096	MXV4-500	2363	MXV4-240
754245	MXV4-590	1607813	MXV4-830	3089	MXV4-360	72097	MXV3-230	2543	MXV4-280
1540241	MXV5-350	1609767	MXV4-520	5163	MXV4-310	72098	MXV3-330	5600	MXV5-480
1540329	MXV5-690	1610577	MXV4-560	6267	MXV4-750	72099	MXV3-280	8140	MXV4-350
7540145	MXV5-690	1610578	MXV4-250	6565	MXV5-510	72101	MXV4-580	8141	MXV4-490
7540151	MXV5-670	1651201	MXV4-730	6566	MXV4-460	72102	MXV4-750	8142	MXV4-260
7540198	MXV4-620	1663009	MXV3-280	9240	MXV4-380	72103	MXV4-890	8143	MXV4-490
7540238	MXV5-490	1664457	MXV4-410	10860	MXV3-350	72106	MXV3-370	8597	MXV4-220
7540244	MXV4-400	1664946	MXV4-570	12038	MXV4-530	72107	MXV3-310	8718	MXV5-490
7540245	MXV4-590	1665706	MXV4-390	12096	MXV4-500	72109	MXV4-320	8868	MXV4-320
7540326	MXV4-620	1666654	MXV3-320	12108	MXV4-530	72110	MXV4-710	8869	MXV4-330
7540367	MXV4-340	1666655	MXV4-410	12096	MXV4-500	72111	MXV4-340	9517	MXV5-490
7540195A	MXV4-540	1667200	MXV4-340	12117	MXV4-300	72112	MXV3-350	10830	MXV4-600
SP2	MXV4-250	1668065	MXV4-690	13472	MXV5-300	72115	MXV4-670	11296	MXV4-780
ALLIS CHALMERS/ DEUTZ		1671788	MXV3-340	13474	MXV5-320	72116	MXV4-710	11361	MXV5-770
1110	MXV4-350	1672732	MXV3-370	15243	MXV4-880	72117	MXV4-300	11483	MXV5-430
2435	MXV4-350	1673667	MXV4-950	15355	MXV4-380	72118	MXV4-470	11635	MXV4-630
6163	MXV3-370	1674312	MXV4-350	21692	MXV3-250	72119	MXV4-300	11904	MXV4-910
6184	MXV3-390	1675005	MXV4-400	22068	MXV4-690	72121	MXV4-340	11905	MXV4-510
14843	MXV4-290	1676460	MXV4-430	23639	MXV5-670	72122	MXV4-720	12903	MXV4-580
24615	MXV4-640	1676461	MXV3-330	23640	MXV5-980	72123	MXV4-520	13376	MXV5-850
27114	MXV4-830	1701251	MXV4-420	25129	MXV4-760	72124	MXV4-650	13394	MXV5-350
101136	MXV4-640	1701257	MXV4-420	25659	MXV3-240	72126	MXV3-330	15638	MXV5-500
105122	MXV5-560	1707740	MXV4-690	26123	MXV4-250	72127	MXV3-380	18358	MXV5-560
105280	MXV5-640	2025341	MXV4-440	26137	MXV3-310	72131	MXV3-360	20317	MXV4-200
105287	MXV5-880	2025364	MXV4-820	26147	MXV3-300	72134	MXV5-330	20555	MXV4-410
105340	MXV5-960	2025461	MXV3-360	26150	MXV4-680	72135	MXV4-630	20556	MXV4-480
106689	MXV4-550	2025463	MXV4-580	30101	MXV3-340	72136	MXV5-680	20715	MXV4-350
106769	MXV4-560	2025492	MXV5-450	31912	MXV5-490	72137	MXV4-510	20716	MXV4-350
108248	MXV4-480	2025641	MXV5-490	32322	MXV4-490	72138	MXV4-310	20717	MXV4-560
108458	MXV4-450	2025663	MXV4-350	32330	MXV4-720	72138	MXV3-300	21053	MXV4-620
118225	MXV4-250	2025712	MXV5-490	32330	MXV3-450	72138	MXV3-330	21058	MXV4-630
118312	MXV4-340	2025879	MXV4-630	34289	MXV4-940	72139	MXV4-960	21059	MXV4-440
121078	MXV4-350	2025893	MXV4-480	34332	MXV4-350	72142	MXV4-340	21170	MXV4-290
121398	MXV4-430	2026066	MXV3-380	34346	MXV5-460	72144	MXV4-890	21615	MXV4-950
152017	MXV5-450	2026081	MXV4-360	34944	MXV4-460	72148	MXV4-580	22224	MXV4-320
154273	MXV5-420	2026266	MXV4-380	34945	MXV4-910	72155	MXV4-650	22958	MXV5-820
156120	MXV4-630	2026268	MXV4-390	35955	MXV4-530	72156	MXV4-350	23072	MXV4-430
158573	MXV4-310	2026270	MXV4-350	36004	MXV4-470	72157	MXV3-330	23098	MXV4-620
161146	MXV4-340	2026324	MXV4-910	36232	MXV4-710	72159	MXV3-210	23212	MXV4-590
162081	MXV4-760	2026378	MXV3-220	36233	MXV4-300	72161	MXV4-640	23214	MXV4-590
164146	MXV4-340	2026499	MXV4-550	36880	MXV4-340	72162	MXV4-640	23223	MXV4-950
165048	MXV4-850	2026755	MXV4-390	36987	MXV4-720	72163	MXV4-640	23748	MXV4-620
170164	MXV4-770	2026869	MXV3-390	41200	MXV4-620	72240	MXV3-250	23796	MXV4-590
172929	MXV3-330	2027102	MXV4-610	41963	MXV4-300	72241	MXV3-240	23882	MXV4-590
174224	MXV4-660	2027114	MXV4-850	43318	MXV4-870	5163131	MXV4-310	24732	MXV4-520
174364	MXV4-490	2027121	MXV4-450	49029	MXV4-450	10860131	MXV3-350	25667	MXV4-560
174486	MXV5-490	2027134	MXV4-700	72024	MXV4-290	12077131	MXV5-410	25686	MXV4-550
174883	MXV4-340	2027168	MXV4-340	72026	MXV5-410	15242131	MXV4-290	26308	MXV5-680
174911	MXV4-440	2027581	MXV4-470	72029	MXV5-490	15355131	MXV4-380	26928	MXV5-830
175361	MXV4-290	2027624	MXV5-960	72038	MXV4-530	17798131	MXV4-400	27323	MXV4-410
176393	MXV3-370	2027639	MXV5-880	72042	MXV3-300	51653131	MXV4-310	28594	MXV4-350
176439	MXV4-740	2028035	MXV4-850	72043	MXV3-290	10860P1	MXV3-350	32668	MXV4-330
176917	MXV4-350	2028241	MXV4-310	72045	MXV5-360	12077P1	MXV5-410	33508	MXV4-910
177452	MXV4-620	2028474	MXV4-490	72046	MXV3-280	15242P1	MXV4-290	37031	MXV4-1000
200554	MXV4-460	2028549	MXV4-240	72048	MXV3-250	15355P1	MXV4-380	37168	MXV4-870
1060520	MXV4-700	2028988	MXV5-490	72049	MXV5-470	17798P1	MXV4-400	39159	MXV4-280
1061520	MXV4-700	2029056	MXV4-570	72050	MXV5-440	34X101	MXV5-490	39454	MXV4-880
1101251	MXV4-420	2029223	MXV4-440	72052	MXV5-690	34X102	MXV5-360	39455	MXV4-630
1101257	MXV4-420	2029348	MXV4-350	72056	MXV4-320	34X104	MXV3-320	40068	MXV4-220
1601238	MXV3-340	2029350	MXV4-530	72060	MXV4-280	34X105	MXV3-250	40899	MXV4-350
		2029622	MXV4-700	72061	MXV4-350	34X69	MXV5-410	41029	MXV4-220
		2029660	MXV4-620	72065	MXV4-360	34X88	MXV3-350	41740	MXV4-380
		2029665	MXV4-1000	72066	MXV3-340	34X89	MXV4-360	42111	MXV5-700
		2029715	MXV4-790	72072	MXV4-350	34X92	MXV5-440	43797	MXV4-560



WARNING: These products can expose you to chemicals including carbon black which is known in the state of California to cause cancer, birth defects or other reproductive harm. For more information visit www.P65WARNINGS.ca.gov

LAWN AND GARDEN EQUIPMENT PART NUMBERS

NOTE: FHP Belt may be upgraded to the MXV Belt, however the FHP Belt SHOULD NOT be substituted for the MXV Belt

Alphabetical sequence by manufacturer

OEM #	Belt No.	OEM #	Belt No.	OEM #	Belt No.	OEM #	Belt No.	OEM #	Belt No.
AYP		83691	MXV3-350	501089	MXV4-300	532161957	MXV4-830	1692J	MXV4-830
43979	MXV4-560	84287	MXV4-400	501161	MXV4-540	532165632	MXV4-1200	174368A	MXV5-900
44148	MXV4-630	84352	MXV5-810	501330	MXV4-310	532166060	MXV3-380	177J	MXV5-430
45187	MXV4-440	88519	MXV3-400	502136	MXV4-310	532170140	MXV4-1130	178J	MXV5-530
47200	MXV4-290	88680	MXV4-320	504193	MXV4-260	532174368	MXV5-900	1835R	MXV5-570
47201	MXV4-250	88690	MXV4-330	507023	MXV3-390	532174883	MXV4-340	1836R	MXV5-550
47390	MXV4-710	91218	MXV4-1120	507750	MXV4-280	532175436	MXV3-320	2295R	MXV5-820
47793	MXV4-250	91798	MXV3-390	508774	MXV3-310	532178138	MXV4-870	23796X	MXV4-950
48530	MXV3-430	91808	MXV4-410	509548	MXV4-290	532180808	MXV5-890	2614J	MXV3-440
49233	MXV3-440	101342	MXV4-930	510228	MXV3-360	532187283	MXV5-1430	2630R	MXV5-680
49570	MXV4-350	110883	MXV4-990	510271	MXV4-350	532191273	MXV5-1430	2692R	MXV5-830
50272	MXV4-350	124293	MXV4-800	511192	MXV4-330	532191723	MXV5-1430	2852H	MXV5-350
50307	MXV3-280	126576	MXV4-820	511193	MXV3-330	532193214	MXV4-920	3103J	MXV4-1000
50597	MXV4-300	130801	MXV4-950	511227	MXV3-410	532196103	MXV5-1480	31X12	MXV4-550
51258	MXV4-680	130969	MXV4-930	511246	MXV3-350	532197242	MXV5-1400	31X26	MXV4-880
53157	MXV4-310	131006	MXV4-990	513727	MXV4-550	532197253	MXV4-1010	31X3	MXV4-460
53558	MXV4-350	131264	MXV4-790	513857	MXV3-410	532405143	MXV4-1070	3350R	MXV4-910
53747	MXV3-300	131290	MXV4-880	513957	MXV3-230	532429636	MXV4-1010	3496H	MXV4-250
53987	MXV4-290	132801	MXV4-520	602420	MXV4-890	535126520	MXV4-880	3541R	MXV5-710
54185	MXV4-340	133035	MXV4-410	641414	MXV5-810	8521220040	MXV5-410	3568H	MXV5-290
54378	MXV4-510	137078	MXV3-320	647411	MXV5-810	100117J	MXV4-690	37031J	MXV4-1000
54622	MXV4-250	137153	MXV4-840	647414	MXV5-810	100614N	MXV4-470	3703J	MXV4-1000
54662	MXV4-250	137283	MXV5-1430	883311	MXV5-730	100670N	MXV4-790	3704J	MXV5-1000
54662	MXV4-250	138255	MXV4-940	976611	MXV3-360	100717N	MXV4-690	3716R	MXV4-870
55936	MXV5-430	138399	MXV4-990	976614	MXV3-360	101342N	MXV4-940	3717R	MXV4-950
55941	MXV5-710	139573	MXV4-840	1071249	MXV4-500	102143X	MXV4-530	3754H	MXV3-330
56823	MXV5-820	140067	MXV4-830	1108536	MXV5-270	102726X	MXV5-470	3754H1	MXV3-330
57955	MXV4-700	140218	MXV4-850	3754141	MXV3-330	103142N	MXV4-930	37X14	MXV4-430
58406	MXV4-650	140294	MXV4-820	4897111	MXV4-350	104022X	MXV4-430	37X15	MXV4-620
58558	MXV4-490	141416	MXV4-840	5006471	MXV3-380	105085X	MXV4-790	37X16	MXV4-590
58577	MXV4-630	144200	MXV4-890	5032024	MXV4-310	105380X	MXV4-880	37X17	MXV4-950
59311	MXV3-210	144959	MXV4-960	5032027	MXV4-280	105732X	MXV4-900	37X2	MXV4-480
59786	MXV4-280	146527	MXV3-320	7540109	MXV4-430	105876X	MXV4-930	37X23	MXV4-430
59849	MXV4-730	148763	B83	7540121	MXV4-310	106035X	MXV4-790	37X27	MXV4-830
59884	MXV4-410	156971	MXV4-820	7540154	MXV4-350	106085X	MXV4-790	37X34	MXV4-770
61346	MXV4-390	157769	MXV3-320	7540177	MXV4-320	1060885X	MXV4-790	37X5	MXV4-350
62828	MXV4-700	158818	MXV4-840	7540189	MXV4-440	106095X	MXV4-790	37X50	MXV4-540
63798	MXV4-530	160855	MXV4-950	7540196	MXV4-300	106381N	MXV4-920	37X51	MXV4-360
64744	MXV5-810	161588	MXV4-830	7540201	MXV4-410	106381X	MXV4-920	37X54	MXV4-830
65016	MXV5-460	161597	MXV4-830	7540220	MXV5-270	106412X	MXV4-690	37X55	MXV4-910
65107	MXV3-310	161741	MXV4-790	7540221	MXV5-520	108103X	MXV4-810	37X59	MXV4-790
65133	MXV3-320	163817	MXV4-950	7540224	MXV5-250	108313X	MXV4-940	37X6	MXV4-350
65284	MXV4-340	165632	MXV4-1200	7540231	MXV4-280	110083X	MXV4-990	37X7	MXV4-560
67346	MXV4-390	166060	MXV3-380	7540232	MXV4-200	110084X	MXV4-930	4322M	MXV4-400
67348	MXV4-470	169178	AA112	7540255	MXV4-350	110833X	MXV4-990	4376J	MXV4-490
67398	MXV4-530	170037	AA105	7540357	MXV4-400	11084X	MXV4-940	4384H	MXV5-710
67438	MXV4-470	170140	MXV-1130	53219478	MXV4-850	1108834X	MXV4-990	4454J	MXV4-640
67788	MXV4-780	174368	MXV5-900	90005938	MXV3-300	110883X	MXV4-990	4703H	MXV5-480
69418	MXV4-920	174369	MXV5-990	90051458	MXV4-390	110884X	MXV4-940	4798J	MXV4-780
69428	MXV4-870	174978	MXV4-850	90053790	MXV3-370	120418X	MXV4-800	4833H	MXV4-410
69438	MXV4-920	175436	MXV3-320	531007562	MXV4-880	121979X	MXV4-880	4866J	MXV4-780
69448	MXV5-710	178138	MXV4-870	532083691	MXV3-350	123451X	MXV4-810	4897H	MXV4-350
70637	MXV4-400	180214	MXV4-870	532106085	MXV4-790	123461X	MXV4-800	4897H1	MXV4-350
71240	MXV4-920	180216	MXV4-830	532110883	MXV4-990	123554X	MXV4-940	4965R	MXV5-640
71408	MXV4-400	180217	180217	532110884	MXV4-940	124293X	MXV4-800	5091H	MXV5-820
71635	MXV4-630	180808	MXV5-890	532124970	MXV4-410	124524X	MXV4-890	5092H	MXV5-490
73794	MXV4-940	187283	MXV5-1430	532125907	MXV4-900	125520X	MXV4-890	5125R	MXV4-680
74164	MXV4-510	191273	MXV5-1430	532126520	MXV4-890	125907X	MXV4-900	5165H	MXV4-700
74212	MXV4-570	191723	MXV5-1430	532130801	MXV4-940	125908X	MXV4-930	518J	MXV4-690
74277	MXV4-610	193103	MXV5-1480	532130969	MXV4-930	125908X	MXV4-930	5296M	MXV3-210
74278	MXV4-800	193214	MXV4-920	532131264	MXV4-790	126520X	MXV4-880	5357H	MXV5-530
74977	MXV3-360	196103	MXV5-1480	532131290	MXV4-880	126520X	MXV4-890	5436H	MXV3-320
75443	MXV3-340	197242	MXV5-1400	532132801	MXV4-520	126576X	MXV4-820	5437R	MXV4-510
75671	MXV3-380	197253	MXV4-1010	532133035	MXV4-410	126907X	MXV4-900	543J	MXV4-670
75761	MXV3-380	265111	MXV4-230	532137078	MXV3-320	130969MS	MXV4-930	5559H	MXV5-800
76018	MXV4-410	302470	MXV4-250	532137153	MXV4-840	131264MS	MXV4-790	5559J	MXV4-940
76019	MXV4-550	302706	MXV4-380	532138255	MXV4-940	1322H	MXV5-290	5600H	MXV5-480
76274	MXV4-590	303310	MXV3-310	532139573	MXV4-840	1323H	MXV5-700	5655R	MXV5-680
76275	MXV4-750	304200	MXV4-200	532140067	MXV4-830	138255CS	MXV4-940	584J	MXV3-360
76672	MXV4-350	304240	MXV4-240	532140218	MXV4-850	138255MS	MXV4-940	5859H	MXV5-570
76806	MXV4-350	304270	MXV4-250	532140294	MXV4-820	138255VA	MXV4-940	5A803	MXV5-420
77375	MXV4-230	304280	MXV4-280	532144200	MXV4-890	140067CS	MXV4-830	6095R	MXV4-660
78303	MXV4-360	304310	MXV4-310	532144959	MXV4-960	140067MS	MXV4-830	6118R	MXV5-760
78750	MXV4-390	304350	MXV4-350	532146527	MXV3-320	140294MS	MXV4-820	634A563	MXV4-350
79477	MXV3-370	305698	MXV4-730	532157769	MXV3-320	144200CS	MXV4-890	6414H	MXV5-810
81229	MXV3-360	405143	MXV4-1070	532161588	MXV4-830	144200MS	MXV4-890	6474H	MXV5-810
82258	MXV4-350	429636	MXV4-1010	532161597	MXV4-830	1563R	MXV5-500	6517H	MXV5-990
83663	MXV3-330	483311	MXV4-410	532161741	MXV4-790	1629J	MXV4-830	6774H	MXV5-810

WARNING: These products can expose you to chemicals including carbon black which is known in the state of California to cause cancer, birth defects or other reproductive harm. For more information visit www.P65WARNINGS.ca.gov

CROSS-REFERENCE - LAWN & GARDEN

LAWN AND GARDEN EQUIPMENT PART NUMBERS

NOTE: FHP Belt may be upgraded to the MXV Belt, however the FHP Belt SHOULD NOT be substituted for the MXV Belt

Alphabetical sequence by manufacturer

OEM #	Belt No.	OEM #	Belt No.	OEM #	Belt No.	OEM #	Belt No.	OEM #	Belt No.
AYP		STD324370	MXV4-350	150173	MXV5-560	1714513	MXV3-230	1739943	MXV3-310
6941R	MXV4-920	STD324410	MXV4-410	170146	MXV3-490	1714690	MXV4-320	1739944	MXV4-350
6942R	MXV4-870	STD324420	MXV4-420	170399	MXV4-440	1714799	MXV4-750	1739945	MXV4-350
6943R	MXV4-920	STD340320	MXV4-320	170647	MXV4-440	1715010	MXV3-340	1741135	MXV4-710
6944R	MXV5-710	BILLEY GOAT		170696	MXV4-440	1715213	MXV4-610	1741334	MXV4-450
7074J	MXV4-650	800250	MXV4-320	170738	MXV3-470	1715611	MXV3-250	1741568	MXV4-950
7075J	MXV5-680	850313	MXV4-280	170746	MXV3-490	1715612	MXV3-320	1741576	MXV4-810
7080J	MXV4-610	850314	MXV4-230	170829	MXV3-380	1715614	MXV3-280	1741577	MXV4-830
7140R	MXV4-400	BOBCAT/ RANSOMES		173574	MXV4-540	1715621	MXV3-300	1741578	MXV4-430
7335H	MXV4-450	38016	MXV5-360	174576	MXV4-810	1715740	MXV5-430	1743816	MXV4-980
758H	MXV4-570	38017	MXV5-440	177844	MXV4-360	1715942	MXV4-470	1743876	MXV4-980
7843M	MXV3-290	38030	MXV5-930	200555	MXV3-460	1715972	MXV4-380	1744493	MXV4-680
805H	MXV4-550	38030	MXV5-930	205656	MXV4-240	1716036	MXV3-310	1746379	MXV3-340
8100H	MXV5-790	38031	MXV5-520	212261	MXV4-870	1716161	MXV4-310	1747188	MXV4-970
8199M	MXV5-450	38038	MXV5-960	213676	MXV4-850	1716307	MXV4-700	1747938	MXV4-960
8200M	MXV5-560	38075	B79	217773	MXV4-400	1716407	MXV4-700	1751597	MXV4-910
8225R	MXV4-350	38076	B84	421313	MXV4-310	1716551	MXV4-850	1752194	MXV3-360
8377J	MXV4-590	38077	MXV5-930	421321	MXV4-360	1716557	MXV4-850	1760958	MXV4-620
8718H	MXV5-490	38111	MXV5-870	421339	MXV4-320	1716570	MXV4-430	1800367	MXV4-330
8833H	MXV5-730	38211	MXV4-360	421412	MXV3-210	1716571	MXV4-340	1813220	MXV4-350
8845R	MXV4-740	38234	MXV5-910	618819	MXV4-430	1716580	MXV4-430	1813271	MXV4-550
9121R	MXV4-1120	38234	MXV5-910	751597	MXV4-910	1717120	MXV4-440	1813561	MXV4-550
9179R	MXV3-390	38275	MXV5-820	1105034	MXV4-350	1717195	MXV4-580	1894063	MXV3-280
9180R	MXV4-410	38389	MXV5-560	1108453	MXV4-200	1717837	MXV4-600	1894272	MXV3-350
9440M	A17A	38439	MXV5-690	1108455	MXV4-220	1717861	MXV4-560	1894335	MXV3-360
9441M	MXV4-360	38440	B82	1108456	MXV4-320	1719203	MXV4-320	7523058	MXV4-280
944DM	A17A	38442	MXV5-680	1108460	MXV4-250	1719269	MXV3-250	7524026	MXV4-300
9495H	MXV4-870	38458	MXV5-620	1108461	MXV4-280	1719731	MXV4-630	7524058	MXV4-460
9496H	MXV4-920	38463	MXV5-620	1108462	MXV4-290	1719783	MXV4-410	17413342	MXV4-450
9517H	MXV5-490	38470	MXV5-640	1108462	MXV4-290	1719783	MXV4-410	18161410	MXV5-350
954-0498	MXV4-670	39116	MXV5-690	1108463	MXV4-300	1720131	MXV4-440	18183220	MXV4-350
9766H	MXV3-360	65032	MXV4-350	1108464	MXV4-310	1720572	MXV4-300	65800530	MXV4-550
9768M	MXV4-400	65082	MXV4-350	1108466	MXV4-330	1720573	MXV4-300	95800500	MXV4-350
9787M	MXV4-430	78030	MXV3-260	1108467	MXV4-340	1720726	MXV4-330	658500530	MXV4-550
J2210	MXV4-210	78031	MXV3-360	1108470	MXV4-350	1720727	MXV4-460	958500500	MXV4-350
J2280	MXV4-280	108024	MXV5-460	1108473	MXV4-400	1720938	MXV3-360	754-0326A	MXV4-620
J2300	MXV4-300	108025	MXV5-520	1108474	MXV4-410	1721574	MXV4-620	754-04003	MXV3-320
J2350	MXV4-350	108071	MXV5-530	1108475	MXV4-420	1721967	MXV4-520	754-04003A	MXV3-320
J2390	MXV4-390	108162	MXV5-500	1108476	MXV4-430	1722074	MXV5-350	9200GD	MXV4-220
J2410	MXV4-410	108173	MXV5-210	1108481	MXV4-480	1722095	MXV5-440	9201GD	MXV4-240
LP2154	MXV4-200	118071	MXV4-350	1108485	MXV4-520	1722238	MXV4-650	954-04285	MXV5-350
LP383	MXV4-240	128099	MXV4-360	1108501	MXV4-680	1722258	MXV4-310	B237453	MXV4-290
LP548	A16A	2188134	MXV5-1010	1108536	MXV5-270	1722344	MXV4-620	P406416	MXV4-420
LP708	MXV5-380	28004A	MXV4-310	1108539	MXV5-300	1722523	MXV4-490	T236321	MXV4-570
LP958	MXV4-220	38013N	MXV5-520	1108547	MXV5-380	1722639	MXV4-350	T239661	MXV3-360
LP992	MXV4-230	38015N	MXV5-870	1108552	MXV5-430	1723056	MXV4-540	W51350	MXV5-350
M202	MXV4-420	38016N	MXV5-360	1108554	MXV5-450	1723060	MXV4-510	W56290SP1	MXV5-290
M425C	MXV4-300	38017N	BX42	1108576	MXV5-670	1723661	MXV3-410	WS290	MXV5-290
M426C	MXV4-450	38039N	MXV5-820	1108743	MXV4-400	1724035	MXV4-680	WSI290	MXV5-290
PP12008	MXV4-820	4965R	MXV5-640	1113533	MXV3-330	1724072	MXV4-350	BRIGGS & STRATTON (MURRAY)	
PP12010	MXV4-830	68200A	MXV4-380	1113852	MXV4-570	1724148	MXV4-750	1245	MXV5-240
PP12012	MXV4-960	68209A	MXV4-410	1124148	MXV4-750	1724261	MXV4-510	1254	MXV4-490
PP13006	MXV3-320	BOLENS		1185434	MXV3-370	1724729	MXV4-350	1256	MXV4-330
PP13007	MXV5-900	1060	MXV4-1080	1185481	MXV3-320	1725253	MXV4-340	1257	MXV4-650
PP13008	MXV5-890	9022	MXV3-220	1185487	MXV3-320	1725407	MXV4-350	10716	MXV4-350
PP13010	MXV4-820	9095	MXV3-270	1236321	MXV4-570	1725603	MXV4-430	11361	MXV4-760
PP21008	MXV4-1070	9200	MXV3-220	1705033	MXV4-220	1726701	MXV4-770	11483	MXV5-430
PP8806	MXV4-1010	9201	MXV4-240	1705034	MXV4-350	1726929	MXV4-380	11904	MXV4-910
PP8807	MXV5-1400	9304	MXV4-290	1705326	MXV4-350	1728133	MXV4-920	12903	MXV4-580
RM2543	MXV4-280	9304	MXV4-290	1706907	MXV4-240	1729716	MXV5-460	16297	MXV5-770
RM2754	MXV4-280	10737	MXV4-310	1707233	MXV4-260	1731719	MXV4-510	20117	MXV4-560
RP8096	MXV4-260	10738	MXV4-360	1708425	MXV4-280	1732126	MXV4-710	20551	MXV4-440
SA975	MXV5-410	10738	MXV4-360	1709698	MXV5-430	1732171	MXV3-430	20555	MXV4-440
SP149	A16A	20565	MXV4-240	1711844	MXV4-360	1732582	MXV4-310	20558	MXV4-640
SP8597	MXV4-220	30315	MXV4-460	1711845	MXV5-440	1732726	MXV4-710	20715	MXV4-350
STD303310	MXV3-310	30329	MXV5-390	1711916	MXV5-440	1732880	MXV4-430	20716	MXV4-350
STD303390	MXV3-390	30334	MXV4-700	1712687	MXV4-470	1733439	MXV4-350	20717	MXV4-560
STD304270	MXV4-250	30392	MXV5-580	1713067	MXV4-290	17336248	MXV4-640	21049	MXV4-550
STD304280	MXV4-280	30421	MXV5-630	1713533	MXV3-330	1736259	MXV4-340	21058	MXV4-630
STD304300	MXV4-300	30422	MXV4-760	1713714	MXV4-430	1736279	MXV4-360	21059	MXV4-440
STD304310	MXV4-310	30425	MXV4-710	1713716	MXV4-350	1736903	MXV4-1000	21508	MXV4-630
STD304340	MXV4-340	30477	MXV4-800	1713716	MXV4-350	1737187	MXV5-950	21614	MXV4-850
STD304350	MXV4-350	37756	MXV4-560	1713852	MXV4-570	1737347	MXV4-690	23072	MXV4-430
STD304390	MXV4-390	50028	MXV4-210	1713853	MXV4-570	1737347	MXV4-690		
STD304490	MXV4-490	50134	MXV3-280	1714106	MXV4-210	1737459	MXV4-590		
STD304700	MXV4-700	50161	MXV4-380	1714107	MXV4-460	1737574	MXV4-540		
STD321468	MXV4-680	60070	MXV3-320	1714115	MXV4-330	1738496	MXV4-650		
		113574	MXV4-540	1714285	MXV4-230	1738511	MXV4-660		
		150168	MXV5-590	1714286	MXV4-480	1739080	MXV4-790		



WARNING: These products can expose you to chemicals including carbon black which is known in the state of California to cause cancer, birth defects or other reproductive harm. For more information visit www.P65WARNINGS.ca.gov

LAWN AND GARDEN EQUIPMENT PART NUMBERS

NOTE: FHP Belt may be upgraded to the MXV Belt, however the FHP Belt SHOULD NOT be substituted for the MXV Belt

Alphabetical sequence by manufacturer

OEM #	Belt No.	OEM #	Belt No.	OEM #	Belt No.	OEM #	Belt No.	OEM #	Belt No.	
23098	MXV4-620	037X89A	MXV4-890	37X66	MXV4-470	PL0861	MXV5-460	131264	MXV4-790	
23148	MXV4-620	037X89HDM	MXV4-890	37X68	MXV4-1010	PL8002	MXV5-440	131290	MXV4-880	
23347	MXV4-820	037X89MA	MXV4-890	37X69	MXV4-800	PL8153	MXV5-470	137078	MXV3-320	
23496	MXV4-740	037X92	MXV4-530	37X7	MXV4-560	CRAFTSMAN			137153	MXV4-840
23796	MXV4-590	037X92MA	MXV4-530	37X70	MXV4-770				23749	MXV4-990
23853	MXV4-430	037X93	MXV5-1090	37X71	MXV4-560	46989	MXV4-550	139573	MXV4-840	
23882	MXV4-590	037X93MA	MXV5-1090	37X75	MXV4-910	47846	MXV5-1140	140067	MXV4-830	
24116	MXV4-950	037X94	MXV3-340	37X80	MXV4-860	48922	350J6	140218	MXV4-850	
24176	MXV4-950	037X94MA	MXV3-340	37X86	MXV4-840	50273	MXV3-340	140294	MXV4-820	
24256	MXV4-880	037X96	MXV4-890	37X87	MXV4-970	51249	MXV3-340	144200	MXV4-890	
75121	MXV4-480	037X96MA	MXV4-890	37X88	MXV4-880	110883	MXV4-990	144959	MXV4-960	
75147	MXV3-390	1713549SM	MXV4-700	37X89	MXV4-860	137589	MXV4-860	144959D	MXV4-950	
75370	MXV3-260	1719911SM	MXV4-1170	37X9	MXV4-440	161588	MXV4-830	146527	MXV3-320	
199612	MXV4-970	1732955SM	MXV4-940	37X92	MXV4-530	165631	MXV4-1110	147883	MXV4-340	
201153	MXV4-620	1734048SM	MXV4-1030	37X93	MXV5-1090	165813	MXV4-850	148763	B83	
700123	MXV5-350	1734130SM	MXV4-700	37X94	MXV3-340	170140	MXV4-1120	156971	MXV4-820	
703761	MXV3-310	1737441YP	MXV4-880	37X96	MXV4-890	179092	A32	157769	MXV3-320	
7100883	MXV3-210	1751417YP	AX36	579932MA	MXV3-330	180213	MXV4-830	160855	MXV4-950	
0037X3	MXV4-460	20557	MXV4-460	7035500YP	MXV4-840	180215	MXV4-830	161597	MXV4-830	
0037X3MA	MXV4-460	21615	MXV4-950	7101749MA	MXV4-970	180215	MXV4-830	1629J	MXV4-830	
037X12	MXV4-550	21649	MXV4-550	7101794YP	MXV4-890	191723	MXV5-1430	1665450SM	MXV4-870	
037X12MA	MXV4-550	23748	MXV4-620	710193	MXV4-840	199612	MXV4-970	1666801SM	MXV4-800	
037X22	MXV4-990	23749	MXV4-990	710209	MXV4-860	313821	MXV3-340	1671076SM	MXV4-980	
037X22MA	MXV4-990	27X27	MXV4-830	710213	MXV4-880	319596	350J6	169178	AA112	
037X26	MXV4-880	333721MA	350J10	710216	MXV4-470	325890	MXV3-350	1721393SM	MXV4-940	
037X26MA	MXV4-880	37X1	MXV4-560	710217	MXV4-890	333721	350J10	1722039SM	MXV4-720	
037X38	MXV4-400	37X10	MXV4-850	7103362YP	MXV3-320	333914	350J10	1726470SM	MXV4-380	
037X38MA	MXV4-400	37X100	MXV3-340	7103364YP	MXV3-320	401603	MXV4-950	1726471SM	MXV4-730	
037X40	MXV4-620	37X100MA	MXV3-340	710341	MXV4-970	402008	180217	1726472SM	MXV4-910	
037X40MA	MXV4-620	37X101	MXV3-340	7104084YP	MXV3-330	402009	402009	1726841SM	MXV4-940	
037X43	MXV4-830	37X101MA	MXV3-340	710531	MXV4-950	405075	MXV4-840	1727773SM	MXV4-700	
037X43MA	MXV4-830	37X106MA	MXV4-890	760976MA	MXV3-350	416954	A32	1727869SM	MXV4-830	
037X45	MXV4-910	37X11	MXV4-950	761788MA	MXV4-390	419271	144200	1732204SM	MXV4-910	
037X45MA	MXV4-910	37X110	MXV4-440	885495YP	MXV4-810	419744	A32	1732224SM	MXV4-540	
037X57	MXV4-540	37X110MA	MXV4-440	885895YP	MXV4-480	429636	MXV4-1010	1732956SM	MXV4-1180	
037X57A	MXV4-540	37X112MA	MXV5-660	954-04259A	MXV4-340	581264	MXV4-350	1732966SM	MXV4-1180	
037X61	MXV4-950	37X12	MXV4-550	954-04285	MXV5-350	585416	MXV4-380	1733324SM	MXV3-330	
037X61AMA	MXV4-950	37X13	MXV3-410	954-0469A	MXV5-910	585436	MXV4-380	1734131SM	MXV4-730	
037X61MA	MXV4-950	37X131MA	MXV4-410	954-05001	MXV4-430	760928	MXV3-350	1736421YP	MXV4-380	
037X61WMA	MXV4-950	37X135MA	MXV3-350	MT1736421YP	MXV4-380	1726470	MXV4-380	1736516YP	MXV4-1320	
037X62	MXV4-860	37X14	MXV4-430	MT333721MA	350J10	1726471	MXV4-730	174368	MXV5-900	
037X62A	MXV4-860	37X15	MXV4-620	MT37X132	MXV3-350	2002648	MXV4-580	174883	MXV4-340	
037X62MA	MXV4-860	37X16	MXV4-590	MT579932	MXV3-330	4143733	MXV5-1510	1751423YP	MXV4-890	
037X62WMA	MXV4-860	37X17	MXV4-940	MT579932MA	MXV3-330	90003526	MXV4-300	1752103YP	MXV5-850	
037X63	MXV4-830	37X21	MXV4-620	MT585416	MXV4-380	532197253	MXV4-1010	175436	MXV3-320	
037X63A	MXV4-830	37X22	MXV4-990	MT585416MA	MXV4-380	532405143	MXV4-1070	177J	MXV5-430	
037X63MA	MXV4-830	37X23	MXV4-430	MU037X74MA	MXV4-570	532429636	MXV4-1010	178138	MXV4-870	
037X65	MXV4-300	37X25	MXV3-380	MU037X87	MXV4-970	120302X	MXV4-900	178J	MXV5-530	
037X65MA	MXV4-300	37X26	MXV4-880	MU037X87MA	MXV4-970	754-0131	MXV3-350	180214	MXV4-870	
037X66	MXV4-470	37X27	MXV4-830	MU1742461YP	MXV4-570	754-0222A	MXV4-440	180217	MXV5-890	
037X66MA	MXV4-470	37X28	MXV4-480	MU37X110	MXV4-440	754-04014	MXV3-270	180808	MXV3-340	
037X68	MXV4-1010	37X29	MXV3-390	MU37X110MA	MXV4-440	754-04201A	MXV3-360	183688	MXV5-1430	
037X68MA	MXV4-1010	37X3	MXV4-460	MU37X111MA	MXV4-450	954-04050	MXV4-350	191273	MXV4-920	
037X69	MXV4-800	37X31	MXV4-930	MU37X57	MXV4-540	954-04202	MXV3-360	193214	MXV4-970	
037X69MA	MXV4-800	37X32	MXV4-450	MU37X65	MXV4-300	954-04260	MXV3-340	194346	MXV4-970	
037X70	MXV4-770	37X34	MXV4-770	BUNTON			954-04260	196103	MXV5-1480	
037X70A	MXV4-770	37X36	MXV4-550				4733	MXV5-570	037X22MA	MXV4-990
037X70MA	MXV4-770	37X37	MXV4-500	G851	MXV4-320	037X38MA	MXV4-400	197253	MXV4-1010	
037X74MA	MXV4-570	37X38	MXV4-400	H121	MXV4-540	037X40MA	MXV4-620	2692R	MXV5-830	
037X75	MXV4-910	37X39	MXV4-830	L148	MXV4-280	037X43MA	MXV4-830	313821MA	MXV3-340	
037X75A	MXV4-910	37X40	MXV4-620	L19	MXV4-360	037X44MA	MXV4-500	319596MA	350J6	
037X75MA	MXV4-910	37X43	MXV4-830	L20	MXV4-350	037X45MA	MXV4-910	325890MA	MXV3-350	
037X75WMA	MXV4-910	37X45	MXV4-910	L21	MXV4-390	037X57MA	MXV4-540	3526MA	MXV4-300	
037X80	MXV4-860	37X46	MXV4-250	L643	MXV4-500	037X61MA	MXV4-950	37X110	MXV4-440	
037X80MA	MXV4-860	37X48	MXV4-730	P78153	MXV5-470	037X62MA	MXV4-860	37X110MA	MXV4-440	
037X86	MXV4-840	37X5	MXV4-350	PL0019	MXV4-360	037X65MA	MXV4-300	37X111	MXV4-450	
037X86A	MXV4-840	37X50	MXV4-540	PL0020	MXV4-350	106085X	MXV4-790	37X111MA	MXV4-450	
037X86MA	MXV4-840	37X51	MXV4-360	PL0021	MXV4-380	106381X	MXV4-920	37X120MA	OE ONLY	
037X87	MXV4-970	37X55	MXV4-910	PL0148	MXV4-280	108429X	MXV4-390	37X130MA	350J10	
037X87MA	MXV4-970	37X56	MXV4-820	PL029	MXV5-440	110883X	MXV4-990	37X26	MXV4-880	
037X88	MXV4-880	37X57	MXV4-540	PL0511	MXV5-540	110884X	MXV4-940	37X38	MXV4-400	
037X88A	MXV4-880	37X59	MXV4-790	PL0543	MXV4-430	123796X	MXV4-950	37X57	MXV4-540	
037X88HDM	MXV4-880	37X6	MXV4-350	PL0619	MXV5-440	125907X	MXV4-900	37X65	MXV4-300	
037X88MA	MXV4-880	37X61	MXV4-950	PL0661	MXV5-580	130801	MXV4-950	39454	MXV4-880	
037X88WMA	MXV4-880	37X62	MXV4-860	PL0679	MXV5-660	130969	MXV4-930	39454MA	MXV4-880	
037X89	MXV4-890	37X63	MXV4-830	PL0848	MXV5-400	131006	MXV4-990	405143	MXV4-1070	

WARNING: These products can expose you to chemicals including carbon black which is known in the state of California to cause cancer, birth defects or other reproductive harm. For more information visit www.P65WARNINGS.ca.gov

CROSS-REFERENCE - LAWN & GARDEN

LAWN AND GARDEN EQUIPMENT PART NUMBERS

NOTE: FHP Belt may be upgraded to the MXV Belt, however the FHP Belt SHOULD NOT be substituted for the MXV Belt

Alphabetical sequence by manufacturer

OEM #	Belt No.	OEM #	Belt No.	OEM #	Belt No.	OEM #	Belt No.	OEM #	Belt No.
40899	MXV4-350	954-04201A	3VX360	954-0197	MXV4-1170	754-3075	MXV5-780	ENCORE	
41740	MXV4-380	954-04204	AX34	954-04082A	MXV3-320	954-0178	MXV5-820		
41740MA	MXV4-380	954-04207	MXV4-790	954-04250	MXV4-630	954-0201	MXV4-410	363210	MXV5-820
43066	MXV5-710	954-04208	MXV5-410	954-04262	MXV5-910	954-0241A	MXV5-350	363211	MXV5-440
43066MA	MXV5-710	954-04219	MXV4-1030	954-0460	MXV3-390	954-0266A	MXV4-850	EXCEL	
438485	MXV3-320	954-04240	MXV4-1630	00050441P	MXV5-820	954-04001	MXV5-700		
48044MA	MXV5-820	954-04244A	MXV4-770	1004752	MXV4-1200	954-04002	MXV5-320	716910	MXV4-440
49570	MXV4-350	954-04249	MXV5-710	473468R2	MXV4-720	954-04032B	MXV3-360	EXMARK	
49570MA	MXV4-350	954-04249A	MXV5-710	488077R1	MXV4-480	954-04033	MXV4-1180		
49581	SPA932	954-04252	MXV4-630	489399R1	MXV4-800	954-04033A	MXV4-1180	213076	MXV4-290
49581MA	SPA932	954-04263	MXV5-400	490489R2	MXV4-810	954-04043	MXV4-570	213077	MXV4-350
50272	MXV4-350	954-04265	MXV4-330	493649R1	MXV4-730	954-04043A	MXV4-570	232300	MXV5-880
50307	MXV3-280	954-0430B	3VX350	50441P	MXV5-820	954-04043B	MXV4-570	303078	MXV5-360
50441	MXV5-820	954-04318	MXV5-450	754-0295	MXV4-1110	954-04044	MXV4-1340	303079	B41
51304	SPA932	954-04331	MXV5-350	754-0330	MXV4-900	954-04044A	MXV4-1340	303080	MXV5-890
5262J	MXV4-390	954-0453	MXV5-360	754-0339	MXV4-790	954-04045	MXV4-1090	323017	MXV5-850
532138255	MXV4-950	954-0460	MXV3-390	754-0349	A77	954-04048	MXV5-1300	323051	MXV5-440
585416MA	MXV4-380	954-0467A	MXV5-910	754-0352	MXV4-480	954-04057	MXV5-350	323200	MXV5-880
585436MA	MXV4-380	954-0493	MXV5-580	754-04001A	MXV5-700	954-04060	MXV4-960	323225	MXV5-520
62828	MXV4-700	954-0494	MXV5-420	754-04002	MXV5-320	954-04060A	MXV4-960	323300	MXV5-880
6474H	MXV5-810	954-0754	MXV5-520	754-04003	MXV4-1180	954-04060B	MXV4-970	403018	MXV3-360
7022252YP	MXV4-730	STD324695	MXV4-700	754-04033A	MXV4-1180	954-04118	MXV4-1220	403024	MXV5-940
7074J	MXV4-650	STD324830	MXV4-830	754-04041	MXV5-1110	954-04137A	MXV4-1140	403025	MXV5-520
7100102SM	MXV4-580	STD324940	MXV4-940	754-04043	MXV4-580	954-04138A	MXV5-1430	413094	MXV5-1040
7103789YP	MXV5-1660	STD324990	MXV4-990	754-04043A	MXV4-580	954-04139	MXV4-720	543548	MXV4-370
73794	MXV4-940	STD325810	MXV5-810	754-04043B	MXV4-580	954-04142	MXV4-910	603045	MXV4-1110
754-0101A	MXV3-350	STD325811	MXV5-810	754-04044	MXV4-1340	954-04145A	MXV4-640	603306	MXV5-810
754-0343	MXV3-310	TH3H340	MXV3-340	754-04044A	MXV4-1340	954-04153	MXV4-1220	603809	MXV5-600
754-0346	MXV3-300	TH5H710	MXV5-710	754-04045	MXV4-1090	954-04153A	MXV4-1220	303080A	MXV5-890
754-0367	MXV4-340	CUB CADET		754-04048	MXV5-1300	954-04158	MXV3-320	DH3012	MXV5-520
754-04013	MXV3-210			754-04055	MXV5-1110	954-04207	MXV4-790	FORD	
754-04050	AX33	50441	MXV5-820	954-04208	MXV5-410	2435	MXV4-320		
754-04102	MXV3-250	106465	MXV4-510	954-04219	MXV4-1030	200555	MXV3-460		
754-04131	MXV4-420	106990	MXV4-450	954-04240	MXV4-1630	240684	MXV3-460		
754-04139	MXV4-720	106991	MXV4-550	954-04244A	MXV4-770	240773	MXV4-740		
754-04145	MXV4-640	135469	MXV5-890	954-0467	MXV5-910	GILSON			
754-04194	MXV4-450	700399	MXV4-1070	954-0467A	MXV5-910				
754-04194A	MXV4-450	702391	MXV5-630	954-0475	MXV5-1090	930	MXV4-520		
754-04195	AX35	704752	MXV5-1190	954-0498	MXV4-670	1040	MXV4-320		
754-04204	AX34	705011	MXV5-830	954-0498	MXV4-560	1110	MXV4-350		
754-0430	MXV3-350	705012	MXV5-840	954-0640	MXV5-790	1409	MXV5-520		
754-0430B	3VX350	708349	MXV4-550	954-0642	MXV5-1380	1434	MXV3-280		
754-0453	MXV5-360	720103	MXV4-810	954-0644	MXV4-600	1526	MXV4-220		
754-0460	MXV3-390	1000399	MXV4-1070	954-0645	MXV4-670	2434	MXV4-340		
754-0493	MXV5-580	1001315	MXV5-840	954-0645A	MXV4-670	2435	MXV4-350		
754-0494	MXV5-420	1002391	MXV5-620	954-3036	MXV4-630	3053	MXV4-440		
754-0754	MXV5-520	1002391	MXV5-630	954-3038	MXV4-610	3660	MXV4-250		
760928MA	MXV3-350	1002932	MXV4-1170	954-3053	MXV4-1070	3866	MXV4-260		
770061MA	MXV3-340	1003968	MXV5-830	954-3055A	MXV4-1120	4051	MXV3-310		
83691	MXV3-350	1004315	MXV5-840	954-3068	MXV5-1110	4052	MXV4-550		
88519	MXV3-400	1004752	MXV4-1170	954-3073	MXV4-620	4638	MXV4-300		
954-0101A	MXV3-350	1004752	MXV5-1190	954-3092A	MXV4-640	6163	MXV3-370		
954-0101A	MXV4-350	1005011	MXV5-830	954-4062	MXV4-780	6184	MXV3-390		
954-0201	MXV4-410	1005012	MXV5-840	954-4077	MXV5-1340	7740	MXV4-380		
954-0222A	MXV4-440	1005374	MXV4-1050	WM-18879	MXV5-1330	7838	MXV3-340		
954-0241A	MXV5-350	1005375	MXV4-1140	WM-53418	MXV5-1580	9303	MXV3-250		
954-0346	MXV3-300	1005376	MXV4-1220	DIXON			9304	MXV4-290	
954-0367	MXV4-340	1005377	MXV5-910				1611	MXV5-780	9305
954-04013	MXV3-210	1005378	MXV5-870	1714	MXV4-520	9308	MXV4-250		
954-04014	MXV3-270	1007015	MXV4-510	1765	MXV4-260	10463	MXV4-350		
954-04043B	MXV4-570	1007937	MXV5-1230	1860	MXV4-570	10755	MXV4-430		
954-04044A	MXV4-1340	1008349	MXV4-550	2412	MXV5-740	10855	MXV4-300		
954-04050	AX33	1008349	MXV5-550	2426	MXV5-440	10897	MXV4-510		
954-04060B	MXV4-970	1009719	MXV5-550	2469	MXV4-450	10923	MXV4-300		
954-04062	MXV4-770	1009719	MXV5-590	4812	MXV4-660	11144	MXV4-350		
954-04083	MXV5-1380	1009787	MXV5-800	6111	MXV5-780	11193	MXV5-890		
954-04102	MXV3-250	2000103	MXV4-810	6360	MXV5-850	11792	MXV5-960		
954-04104A	MXV4-450	2000154	MXV4-830	6938	MXV5-380	11793	MXV5-900		
954-04131	MXV4-420	2000611	MXV5-1550	6939	MXV5-390	11943	MXV4-360		
954-04137A	MXV4-1140	2000653	MXV4-910	7725	MXV5-720	12023	MXV5-350		
954-04139	MXV4-720	2002648	MXV4-580	9236	MXV5-930	12570	MXV5-560		
954-04145A	MXV4-640	2004377	B107	EDCO			12684	MXV5-960	
954-04158	MXV3-320	2005168	MXV5-860				20560	MXV4-500	13009
954-04185	MXV4-890	754-0271	MXV3-390	20939	MXV5-620	13072	MXV4-720		
954-04194A(x6)	MXV4-450	754-04047	MXV4-1140			13436	MXV4-540		
954-04195	AX35	754-3038	MXV4-610						
954-04201	3VX360	754-3068	MXV5-1100						



WARNING: These products can expose you to chemicals including carbon black which is known in the state of California to cause cancer, birth defects or other reproductive harm. For more information visit www.P65WARNINGS.ca.gov

LAWN AND GARDEN EQUIPMENT PART NUMBERS

NOTE: FHP Belt may be upgraded to the MXV Belt, however the FHP Belt SHOULD NOT be substituted for the MXV Belt

Alphabetical sequence by manufacturer

OEM #	Belt No.	OEM #	Belt No.	OEM #	Belt No.	OEM #	Belt No.	OEM #	Belt No.
14156	MXV4-400	GRASSHOPPER		HONDA		4460951	MXV4-550	4461795	MXV5-790
14159	MXV4-400	381100	MXV5-290	12151	MXV4-320	4460969	MXV4-560	4461800	MXV5-800
14167	MXV4-650	381914	MXV4-360	40206	MXV4-320	4460977	MXV4-570	4461818	MXV5-810
14168	MXV4-510	382000	MXV5-330	41562	MXV5-370	4460985	MXV4-580	4461826	MXV5-820
14365	MXV4-510	382037	MXV5-650	47562	MXV5-370	4460993	MXV4-590	4461834	MXV5-830
14790	MXV4-380	382049	MXV5-820	47765	MXV5-360	4461004	MXV4-600	4461842	MXV5-840
14843	MXV4-290	382730	MXV5-350	68851	MXV5-300	4461012	MXV4-610	4461850	MXV5-850
16146	MXV4-390	382750	MXV5-390	68851	MXV5-310	4461020	MXV4-620	4461868	MXV5-850
16348	MXV4-380	382800	MXV5-520	74313	MXV3-350	4461038	MXV4-630	4461876	MXV5-880
16366	MXV4-350	383000	MXV5-900	75624	MXV5-400	4461046	MXV4-640	4461884	MXV5-900
16386	MXV4-400	GRAVELY		78838	MXV5-380	4461054	MXV4-650	4461892	MXV5-940
17518	MXV5-600	41545	MXV4-350	101316	MXV3-350	4461062	MXV4-660	4461907	MXV5-960
17569	MXV4-430	49029	AX45(2)	103641	MXV5-360	4461070	MXV4-670	4461915	MXV5-980
17653	MXV4-470	72224	AX45(2)	106375	MXV5-330	4461088	MXV4-680	4461923	MXV5-1000
18055	MXV4-300	72224	AX45(2)	126151	MXV3-320	4461096	MXV4-690	4461931	MXV4-1030
18263	MXV4-440	72250	AX35	2487494	MXV5-630	4461101	MXV4-700	4461949	MXV4-1050
24602	MXV4-990	72258	AX51(2)	7618175003	MXV5-670	4461119	MXV4-710	4461957	MXV4-1070
24615	MXV4-640	7225800	AX51(2)	22431723772	MXV3-350	4461127	MXV4-720	4461965	MXV4-1140
26345	MXV4-300	954-771	MXV3-350	22431727003	MXV5-390	4461135	MXV4-730	4461973	MXV4-1170
26873	MXV4-670	HABAN		22431736003	MXV4-350	4461143	MXV4-740	4461981	MXV5-1030
27093	MXV4-470	10467	MXV4-520	22431738003	MXV4-330	4461151	MXV4-750	754-0326A	MXV4-620
27666	MXV4-1020	HOMELITE		22431738701	MXV4-320	4461169	MXV4-760	754-0338	MXV4-770
35545	MXV4-400	9304	MXV4-290	22431747000	MXV5-390	4461177	MXV4-770	754-04003	MXV3-320
36019	MXV3-200	66455	MXV4-510	22432732013	MXV5-280	4461185	MXV4-780	754-04074A	MXV4-780
36770	MXV4-350	66818	MXV4-350	22432732671	MXV5-290	4461193	MXV4-790	754-0456	MXV3-290
36806	MXV5-530	105340	MXV5-960	22432736003	MXV5-330	4461208	MXV4-800	754-0462	MXV5-1380
37156	MXV4-560	108248	MXV4-480	22432736701	MXV5-330	4461216	MXV4-810	754-0637A	MXV3-310
37169	MXV4-360	108428	MXV4-480	22432738831	MXV5-370	4461224	MXV4-820	754-4001A	MXV5-690
37230	MXV4-380	108505	MXV4-700	76181150003	MXV5-660	4461232	MXV4-830	954-04074A	MXV4-780
37756	MXV4-560	108508	MXV4-780	76181750003	MXV5-660	4461240	MXV4-840	954-04285	MXV5-350
200414	MXV4-830	114364	MXV4-490	76181750030	MXV5-660	4461258	MXV4-850	HUSQVARNA	
200416	MXV4-320	120178	MXV4-350	76181750030	MXV5-660	4461266	MXV4-860	183688	754-0367
200554	MXV4-460	123073	MXV4-910	22431738A01	MXV4-330	4461274	MXV4-870	194346	MXV4-970
200555	MXV3-460	158573	MXV4-310	22432738C31	MXV5-360	4461282	MXV4-880	196857	MXV3-330
200624	MXV5-800	161098	MXV4-390	761811510030	MXV5-710	4461290	MXV4-900	303241	MXV4-900
200625	MXV4-560	162081	MXV4-760	76181763A000	MXV5-730	4461305	MXV4-920	310275	MXV4-820
200626	MXV5-400	165048	MXV4-850	761821510130	MXV5-530	4461313	MXV4-940	53216520	MXV4-890
200804	MXV4-740	174364	MXV4-490	761827510130	MXV5-530	4461321	MXV4-960	506033003	MXV3-340
200973	MXV4-780	174731	MXV4-530	761847517010	MXV5-630	4461339	MXV4-980	506070520	3VX350
200982	MXV4-780	174883	MXV4-340	M35	MXV3-350	4461347	MXV4-1000	506347420	3VX340
200983	MXV5-810	176393	MXV3-370	HUSKEE/HUSKY		4461355	MXV5-350	506372720	3VX350
207925	MXV3-320	176439	MXV4-740	2435	MXV4-350	4461371	MXV5-370	510201201	MXV5-1590
208301	MXV4-330	176917	MXV4-350	4460618	MXV4-210	4461389	MXV5-380	510201301	MXV5-1830
208525	MXV3-250	304393	A17A	4460626	MXV4-220	4461402	MXV5-400	522795901	MXV5-1630
208526	MXV3-380	307870	MXV4-350	4460634	MXV4-230	4461410	MXV5-410	522811301	MXV5-1480
208527	MXV4-480	307913	MXV4-220	4460642	MXV4-240	4461428	MXV5-420	522829601	MXV5-1760
208626	MXV3-270	312104	MXV4-360	4460650	MXV4-250	4461436	MXV5-430	522999901	MXV5-1130
208827	MXV4-800	313175	MXV4-200	4460668	MXV4-260	4461444	MXV5-440	531002630	MXV5-360
209310	MXV4-390	313775	MXV4-200	4460676	MXV4-250	4461452	MXV5-450	531002635	MXV5-320
209373	MXV4-410	314804	MXV4-200	4460684	MXV4-280	4461460	MXV5-460	531030352	MXV3-340
209375	MXV4-440	342780	MXV4-200	4460692	MXV4-290	4461478	MXV5-470	531300766	A93
209581	MXV4-860	1601520	MXV4-700	4460707	MXV4-300	4461486	MXV5-480	531300767	MXV5-970
209630	MXV4-390	1601524	MXV4-780	4460715	MXV4-310	4461494	MXV5-490	531300771	MXV5-890
211173	MXV4-400	1602157	MXV4-730	4460723	MXV4-320	4461509	MXV5-500	531300773	MXV4-830
211650	MXV3-330	1603075	MXV4-920	4460731	MXV4-330	4461517	MXV5-510	532002614	MXV3-440
212086	MXV4-400	1603077	MXV4-820	4460749	MXV4-340	4461525	MXV5-520	532104022	MXV4-430
212221	MXV4-390	1604406	MXV4-830	4460757	MXV4-350	4461533	MXV5-530	532123461	MXV4-800
212261	MXV4-870	1607051	MXV4-700	4460765	MXV4-360	4461541	MXV5-540	532123796	MXV4-950
212776	MXV4-660	1607416	MXV4-690	4460773	MXV4-350	4461557	MXV5-560	532124293	MXV4-800
213676	MXV4-850	1607967	MXV4-520	4460781	MXV4-380	4461567	MXV5-580	532124525	MXV4-890
214110	MXV4-580	1665706	MXV4-390	4460799	MXV4-390	4461583	MXV5-600	532131006	MXV4-990
216594	MXV4-1020	3L240	MXV3-240	4460804	MXV4-400	4461606	MXV5-620	532132672	MXV4-510
239024	MXV5-990	3L280	MXV3-280	4460812	MXV4-410	4461622	MXV5-640	532138399	MXV4-590
239025	MXV5-830	4L310	MXV4-310	4460820	MXV4-420	4461630	MXV5-660	532141416	MXV4-840
240684	MXV3-460	JA392594	MXV4-960	4460838	MXV4-430	4461648	MXV5-670	532148763	B83
240773	MXV4-740	JA392606	MXV4-930	4460846	MXV4-440	4461656	MXV5-680	532156971	MXV4-820
243110	MXV4-500	JA990738	MXV4-520	4460854	MXV4-450	4461664	MXV5-690	532160855	138255
2004H	MXV4-830	JA991488	MXV4-730	4460862	MXV4-460	4461680	MXV5-700	532161850	MXV4-850
208S27	MXV4-480	JA992251	MXV4-640	4460870	MXV4-470	4461703	MXV5-720	532165555	180217
4816G	MXV4-870	JA992638	MXV4-390	4460888	MXV4-480	4461711	MXV5-740	532165631	MXV4X1110
83EA335	MXV5-580	JA992639	MXV4-650	4460896	MXV4-490	4461729	MXV5-760	532165813	MXV4-850
GB213676	MXV4-850	HOMKO		4460896	MXV4-490	4461737	MXV5-730	532169778	402009
GB237736	MXV4-860	20317	MXV4-200	4460901	MXV4-500	4461745	MXV5-740	532170140	MXV4-1130
H09	MXV5-520	20582	MXV4-430	4460919	MXV4-510	4461753	MXV5-750	532174369	MXV5-890
H34	MXV3-280	4460927	MXV4-520	4460935	MXV4-530	4461761	MXV5-760	532174383	MXV4-840
H843	MXV4-290	4460943	MXV4-540	4460943	MXV4-540	4461779	MXV5-770	532179092	AX32
						4461787	MXV5-780	532194346	MXV4-970

WARNING: These products can expose you to chemicals including carbon black which is known in the state of California to cause cancer, birth defects or other reproductive harm. For more information visit www.P65WARNINGS.ca.gov

LAWN AND GARDEN EQUIPMENT PART NUMBERS

NOTE: FHP Belt may be upgraded to the MXV Belt, however the FHP Belt SHOULD NOT be substituted for the MXV Belt

Alphabetical sequence by manufacturer

OEM #	Belt No.	OEM #	Belt No.	OEM #	Belt No.	OEM #	Belt No.	OEM #	Belt No.
532300773	MXV4-830	307870	MXV4-350	336481	MXV5-430	M126009	MXV4-860	M72031	MXV4-600
532405029	MXV4-1070	307913	MXV4-220	336488	MXV5-430	M126012	MXV5-950	M72683	MXV4-990
532408007	MXV5-380	309082	MXV3-380	342307	MXV4-860	M126536	MXV4-1440	M72685	MXV4-990
532408010	MXV5-370	309507	MXV3-220	342660	MXV5-770	M127523	MXV5-900	M73223	MXV4-800
532408381	MXV4-960	310046	MXV3-360	342780	MXV4-200	M127524	MXV4-910	M73478	MXV4-590
532416954	AX32	310119	MXV4-320	343359	MXV5-720	M12907	MXV5-500	M73604	MXV3-340
532419271	MXV4-880	310391	MXV4-250	344218	MXV4-650	M136927	MXV4-1080	M74747	MXV4-1050
532419744	A32	310538	MXV5-360	348720	MXV4-720	M138583	AA113	M75353	MXV4-640
532420807	MXV4-810	310917	MXV4-350	349006	MXV5-410	M139970	MXV4-1310	M75746	MXV4-410
532427304	MXV4-370	311419	MXV4-280	349079	MXV4-770	M140502	MXV4-950	M77167	MXV3-340
532428454	MXV4-290	311496	MXV4-570	358577	MXV4-310	M143019	AX62	M77670	MXV4-390
532437261	MXV4-290	311621	MXV5-790	390008	MXV4-470	M143888	MXV5-1110	M77671	MXV5-420
532441597	MXV4-720	311649	MXV5-250	390188	MXV4-440	M144044	MXV4-920	M77672	MXV5-610
533048044	MXV5-820	311650	MXV5-330	390422	MXV4-320	M144570	MXV4-970	M77673	MXV5-630
533303241	MXV4-900	311735	MXV3-420	392410	MXV4-410	M147044	MXV4-900	M77674	MXV4-200
5339000334	MXV4-310	311749	MXV4-530	392433	MXV5-510	M148269	MXV4-1310	M77675	MXV4-210
539000336	MXV4-440	312104	MXV4-350	392445	MXV4-280	M151276	MXV5-970	M77988	MXV4-600
539000339	MXV5-360	312529	MXV3-240	392456	MXV3-370	M151649	MXV4-1440	M800048	MXV4-320
539100439	MXV4-350	312571	MXV5-290	501294	MXV3-330	M152284	MXV4-900	M81035	MXV4-350
539101228	MXV5-460	312795	MXV5-320	545294	MXV4-640	M152398	MXV4-1510	M81036	MXV4-330
539102548	MXV5-1120	313254	MXV3-250	546341	MXV5-250	M153160	BB154	M81037	MXV4-320
539102549	MXV5-1430	313267	MXV4-290	546342	MXV5-310	M154157	A40	M81055	MXV4-350
539102903	MXV5-1230	313582	MXV5-250	546343	MXV4-520	M154294	MXV4-1190	M81056	MXV4-330
539103241	MXV5-600	313775	MXV4-200	JA990738	MXV4-520	M154601	MXV4-1410	M81057	MXV4-320
539103687	MXV5-1520	314012	MXV4-400	JA991488	MXV4-730	M154621	MXV4-1490	M811281	MXV4-320
539104336	MXV5-1800	314042	MXV3-230	JA992251	MXV4-640	M154958	MXV5-1110	M81805	MXV4-490
539105477	MXV4-400	314564	MXV4-290	REM1415	MXV4-200	M154960	MXV5-1200	M82167	MXV4-510
539105644	B131	314600	MXV5-660			M155343	MXV4-600	M82258	MXV5-400
539107709	MXV5-1430	315375	MXV5-780			M155368	MXV5-1900	M82460	MXV4-660
539109242	MXV5-1360	315402	MXV4-320			M155525	MXV4-1410	M82461	MXV4-390
539109243	MXV5-1350	316910	MXV4-430	AM100465	MXV5-330	M156261	MXV5-1640	M82462	MXV4-660
539110410	MXV4-1050	317375	MXV4-310	AM108054	MXV4-560	M158130	MXV4-1500	M82612	MXV4-360
539110411	A54	324136	MXV4-200	AM31159	MXV4-280	M158131	MXV4-1520	M82718	MXV4-900
539110413	A54	325074	MXV4-840	AM32172	MXV4-350	M160571	MXV4-1070	M82719	MXV4-490
539111305	MXV4-340	325221	MXV5-640	AM32636	MXV4-360	M160956	MXV4-590	M82720	MXV4-450
539111949	MXV5-1520	325275	MXV4-430	AM35380	MXV4-410	M163540	MXV4-1100	M82721	MXV4-870
539112529	MXV5-1750	325887	MXV4-590	D28125	MXV4-740	M163989	MXV5-1110	M82734	MXV4-600
539114557	MXV5-1540	325910	MXV3-330	GC00061	MXV3-350	M163990	MXV5-1200	M83837	MXV4-880
539116424	MXV5-1220	325983	MXV5-280	GX10062	MXV4-1060	M40015	MXV5-350	M84075	MXV4-790
539117245	MXV5-1220	325984	MXV5-330	GX10063	MXV4-1420	M40222	MXV4-280	M84136	MXV4-1010
539117811	MXV5-1060	326227	MXV3-350	GX20006	A88	M40223	MXV4-870	M84223	MXV4-620
539120772	MXV4-430	326308	MXV4-690	GX20072	MXV4-1040	M40224	MXV4-570	M84225	MXV4-620
539173589	MXV4-840	326946	MXV5-690	GX20241	MXV4-920	M40757	MXV4-770	M85442	MXV4-440
574285901	MXV5-1700	328821	MXV4-830	GX20305	MXV4-1390	M41335	MXV3-320	M86060	MXV4-430
574286001	MXV5-2010	328825	MXV4-840	GX21395	MXV5-1590	M41555	MXV3-320	M86421	MXV4-530
574845601	MXV5-1270	328826	MXV4-780	GX21407	MXV4-890	M41592	MXV4-400	M86422	MXV4-630
574845602	MXV5-1350	328892	MXV4-830	GX21833	A140	M41642	MXV4-620	M86996	MXV4-870
574845603	MXV5-1430	328973	MXV4-630	GX21986	MXV4-870	M41668	MXV4-980	M88184	MXV4-600
576667201	AX85	329184	MXV4-840	GX22036	MXV4-920	M41960	MXV4-1020	M88462	MXV4-660
601000194	MXV4-900	329193	MXV4-900	GX22269	MXV3-380	M41985	MXV3-360	M89112	MXV4-880
601000921	MXV5-1290	329205	MXV4-450	LVU21853	MXV5-1160	M42226	MXV5-250	M89832	MXV4-790
601001437	MXV3-330	329207	MXV4-360	M110312	MXV5-650	M42485	MXV4-460	M90958	MXV4-550
601001737	MXV4-350	329253	MXV4-900	M110313	MXV5-1110	M43106	MXV3-390	M91147	MXV4-630
601001762	MXV3-350	330447	MXV4-670	M110367	MXV5-890	M43489	MXV4-570	M91270	MXV4-470
601002148	MXV4-330	330448	MXV4-280	M110599	MXV3-300	M43569	MXV4-500	M91330	MXV4-640
606000226	3VX330	330463	MXV4-760	M110766	MXV3-360	M43586	MXV4-680	M91470	MXV5-470
102655X	MXV4-380	330503	MXV4-970	M110776	MXV3-360	M43795	MXV4-410	M93748	MXV5-460
532125907	MXV4-900	330559	MXV5-460	M110797	MXV4-380	M43820	MXV4-740	M94020	MXV4-490
532130969	MXV4-930	330599	MXV4-350	M110978	MXV4-1020	M44121	MXV5-670	M94049	MXV5-430
532137153	MXV4-840	330675	MXV4-280	M111534	MXV5-1300	M44178	MXV3-290	M94829	MXV4-310
532138255	MXV4-940	330790	MXV4-360	M111564	BB123	M44272	MXV4-800	M95121	MXV4-430
532140218	MXV4-850	331325	MXV3-400	M112006	MXV4-630	M44483	MXV4-480	M95122	MXV4-830
532140294	MXV4-820	331594	MXV4-320	M112490	MXV4-990	M44498	MXV4-600	M97340	MXV3-330
532144959	MXV4-960	331672	MXV4-480	M114763	MXV4-850	M45254	MXV4-860	PT12668	MXV5-540
532174368	MXV5-900	331807	MXV3-240	M115776	MXV4-1070	M45489	MXV4-570	PT13490	MXV3-330
532178138	MXV4-870	331808	MXV3-320	M117608	MXV4-590	M45862	MXV4-470	PT15219	MXV5-460
532191273	MXV5-1430	331846	MXV4-510	M117636	B129	M45863	MXV4-560	PT15220	MXV4-460
532194346	MXV4-970	331847	MXV4-480	M118048	MXV5-850	M45998	MXV4-830	PT15260	MXV3-350
532196103	MXV5-1480	331876	MXV4-690	M118685	MXV5-1200	M46758	MXV4-360	PT2303	MXV3-370
532197242	MXV5-1400	332051	MXV4-290	M118756	MXV5-1230	M47043	MXV4-790	PT5300	MXV4-570
532197253	MXV4-1010	332111	MXV4-440	M118760	MXV4-980	M47159	MXV4-300	PT5302	MXV4-390
532405143	MXV4-1070	333719	MXV5-620	M119539	MXV4-1370	M47765	MXV4-840	PT7513	MXV3-220
532429636	MXV4-1010	335453	MXV4-410	M119656	MXV5-620	M47766	MXV4-800	PT8666	MXV5-540
	JACOBSON	335832	MXV4-380	M119713	MXV5-860	M47770	MXV4-580	PT8669	MXV4-430
1024	MXV4-570	335856	MXV4-390	M120381	BB123	M48520	MXV4-250	PT8676	MXV4-500
2058	MXV4-300	336055	MXV3-320	M122674	MXV4-920	M49920	MXV4-990	PT8679	MXV5-370
304393	A17A	336219	MXV4-300	M122907	MXV5-500	M71026	MXV4-840	PT8697	MXV5-320
307522	MXV4-420	336262	MXV4-320	M123281	MXV4-1440	M71135	MXV4-740	PT8698	MXV5-460
		336263	MXV4-250	M125218	MXV4-960	M71529	MXV4-650	PT8716	MXV4-460



WARNING: These products can expose you to chemicals including carbon black which is known in the state of California to cause cancer, birth defects or other reproductive harm. For more information visit www.P65WARNINGS.ca.gov

LAWN AND GARDEN EQUIPMENT PART NUMBERS

NOTE: FHP Belt may be upgraded to the MXV Belt, however the FHP Belt SHOULD NOT be substituted for the MXV Belt

Alphabetical sequence by manufacturer

OEM #	Belt No.	OEM #	Belt No.	OEM #	Belt No.	OEM #	Belt No.	OEM #	Belt No.	
RG60874	A39	606248	MXV4-330	320272216	MXV4-310	16366	MXV4-350	200416	MXV5-320	
TCU13195	MXV5-1160	606250	MXV4-520	320272217	MXV4-760	16386	MXV4-400	200624	MXV5-800	
TCU13196	MXV5-1320	606508	MXV4-480	320312212	MXV4-640	17518	MXV4-600	200625	MXV4-560	
TCU13198	MXV5-1410	607198	MXV4-400	320359328	MXV4-500	17569	MXV4-430	200626	MXV5-400	
TCU16036	C173	607270	MXV4-320	320372204	MXV4-380	17653	MXV4-470	200804	MXV4-740	
TCU16093	MXV5-1570	607271	MXV4-440	27220S	MXV4-400	18055	MXV4-300	200982	MXV4-780	
TCU16122	MXV4-1000	607980	MXV4-620	L346	MXV3-460	18263	MXV4-400	200983	MXV5-810	
TCU16495	MXV5-1260	608016	MXV4-540	L557	MXV5-570	19037	MXV4-210	203832	MXV4-320	
TCU17289	MXV4-400	608017	MXV4-650	M35932580	MXV4-500	24602	MXV4-990	203839	MXV4-390	
TCU18117	MXV5-1360	608474	MXV4-620	MC COLLOCH		35545	MXV4-400	208526	MXV3-380	
TCU18602	MXV5-1480	608475	MXV4-700	1110	MXV4-350	36770	MXV4-350	208626	MXV3-270	
TCU18603	MXV5-1560	608476	MXV4-560	1526	MXV4-220	36806	MXV5-530	209581	MXV4-860	
TCU19609	MXV5-1500	610040	MXV3-440	MC LANE		37756	MXV4-560	209630	MXV4-390	
TCU20002	MXV4-540	611803	MXV3-320	1060	MXV4-1080	37757	MXV4-830	210752	MXV4-700	
TCU20822	B42	612652	MXV3-320	41300	MXV4-300	41969	MXV5-500	210753	MXV4-310	
TCU21814	B48	6080147	MXV4-350	4L300	MXV4-300	41980	MXV4-670	211650	MXV3-330	
TCU22550	MXV4-720	6080157	MXV4-530	MERRY TILLER		41993	MXV4-590	211664	MXV4-360	
TCU22697	MXV5-1800	6080257	MXV4-680	329	MXV4-450	52538	MXV4-240	212776	MXV4-660	
TCU26904	MXV5-1590	240773L	MXV4-740	594	MXV4-340	100162	MXV4-220	214110	MXV4-580	
TCU26905	MXV5-1700	608014T	MXV4-350	862	MXV4-400	102625	MXV4-530	217773	MXV4-400	
TCU26906	MXV5-1820	608015T	MXV4-530	1023	MXV4-430	106123	MXV4-260	265123	MXV4-330	
TCU26908	MXV5-1730	608025T	MXV4-680	1530	MXV4-350	106390	MXV4-360	265140	MXV5-560	
TCU26909	MXV5-1860	GB235000	MXV5-500	1637	MXV3-390	106689	MXV4-550	308458	MXV5-360	
KEES/YAZOO			MASSEY			108099	MXV4-440	484620	MXV3-280	
1248	MXV4-260	2058	MXV4-300	1984	MXV4-450	108115	MXV4-560	503849	MXV4-490	
60119	MXV5-440	1023435M1	MXV4-340	2031	MXV4-500	108151	MXV4-630	503855	MXV4-550	
103032	MXV5-360	1023436M1	MXV4-290	2059	MXV4-500	108248	MXV4-480	504250	MXV5-500	
363143	MXV5-890	1023564M1	MXV4-250	2270	MXV4-410	108300	MXV4-420	504251	MXV5-510	
483012	MXV5-520	1023608M1	MXV4-290	2278	MXV4-410	119037	MXV4-780	504253	MXV5-530	
483013	MXV5-940	1023850M1	MXV5-850	2313	MXV3-450	121078	MXV4-350	754101	MXV4-350	
483023	MXV5-370	1023886M1	MXV5-620	2391	MXV4-360	121216	MXV4-380	754104	MXV4-320	
205-505	AA80	1025542M1	MXV4-500	2404	MXV3-300	121228	MXV4-350	754105	MXV4-300	
532-138498	MXV4-960	1025557M1	MXV4-750	3292	MXV4-340	122060	MXV3-360	754107	MXV4-300	
532-140294	MXV4-820	1025796M1	MXV3-300	48350	MXV4-350	122120	MXV3-330	754109	MXV4-430	
532-191273	MXV5-1430	1029730M1	MXV5-630	MIGHTY MAC		122146	MXV3-380	754112	MXV5-800	
539-103241	MXV4-600	1030050M1	MXV4-490	300001	MXV4-380	152017	MXV5-450	754113	MXV5-480	
539-103687	MXV5-1520	1030063M1	MXV5-330	300038	MXV4-550	154273	MXV5-420	754114	MXV4-240	
539-107709	MXV5-1430	1032843M1	MXV4-720	300113	MXV4-530	154307	MXV4-350	754121	MXV4-310	
539-107710	MXV4-650	3021192M1	MXV4-960	7010318	MXV4-420	156120	MXV4-630	754136	MXV5-310	
VB62F	MXV5-390	511277M2	MXV4-500	7010319	MXV4-540	156231	MXV4-420	754138	MXV5-500	
LAWN CHIEF			511277M3	MXV4-500	3L450	MXV3-450	165112	MXV4-190	754142	MXV3-310
1540	MXV5-400	511485M1	MXV4-320	4L500	MXV4-500	165129	MXV4-260	754143	MXV3-280	
10737	MXV4-310	514132M1	MXV4-300	MONTGOMERY WARD		165130	MXV4-290	754144	MXV5-550	
20716	MXV4-350	51432M1	MXV4-200	1060	MXV4-1080	165132	MXV4-250	754145	MXV5-690	
20717	MXV4-560	514806M1	MXV4-350	1409	MXV5-520	165133	MXV4-350	754151	MXV5-670	
21615	MXV4-950	514891M1	MXV4-820	1434	MXV3-280	165138	MXV4-400	754157	MXV5-280	
49405	MXV4-880	518125M1	MXV4-400	2006	MXV4-280	165139	MXV4-560	754163	MXV4-280	
111215	MXV4-820	518223M1	MXV4-280	2119	MXV4-210	165141	MXV4-400	754167	MXV5-640	
135194	MXV4-890	519958M1	MXV4-770	2435	MXV4-350	165142	MXV4-410	754173	MXV5-370	
135863	MXV4-400	523733M1	MXV4-360	4638	MXV4-300	165143	MXV4-560	754177	MXV4-320	
136176	MXV5-780	523734M1	MXV4-580	4825	MXV4-600	165145	MXV4-630	754180	MXV5-540	
136705	MXV4-340	530669M1	MXV4-350	7757	MXV4-830	165153	MXV4-620	754181	MXV4-1000	
136762	MXV4-680	MAXIM			165154	MXV4-640	165154	MXV4-640	754182	MXV5-810
136887	MXV4-430	1346	MXV3-460	9303	MXV3-250	165159	MXV4-580	754185	MXV4-490	
LAWN-BOY			1557	MXV5-570	9305	MXV4-520	165160	MXV4-400	754186	MXV4-820
2499	MXV4-360	272201	MXV4-510	9581	MXV4-860	165161	MXV5-610	754188	MXV5-510	
11193	MXV5-890	272212	MXV4-640	10111	MXV4-290	165163	MXV4-650	754189	MXV5-510	
14790	MXV4-380	272217	MXV4-760	10755	MXV4-430	165166	MXV4-640	754194	MXV4-450	
16146	MXV4-390	272220	MXV4-280	11144	MXV4-410	165167	MXV4-390	754195	MXV4-540	
16366	MXV4-350	272222	MXV4-560	11723	MXV4-230	165168	MXV4-670	754198	MXV4-620	
16386	MXV4-400	272223	MXV4-640	11723	MXV4-230	165168	MXV4-640	754203	MXV5-610	
18055	MXV4-300	272224	MXV4-530	11792	MXV5-960	165169	MXV5-510	754204	MXV4-670	
25090	MXV4-600	272229	MXV4-310	11793	MXV5-900	165171	MXV5-630	754205	MXV3-320	
45589	MXV4-350	272234	MXV5-880	11901	MXV4-360	165172	MXV4-670	754206	MXV4-500	
103347	MXV5-510	272235	MXV5-670	11943	MXV5-350	165173	MXV5-630	754207	MXV4-420	
207925	MXV3-320	272236	MXV5-570	12023	MXV3-210	165174	MXV4-670	754208	MXV4-550	
208626	MXV3-270	272237	MXV4-400	12510	MXV5-560	165175	MXV5-450	754217	MXV5-790	
212776	MXV4-660	272240	MXV4-320	12570	MXV5-560	165179	MXV5-780	754219	MXV4-260	
235000	MXV5-500	272241	MXV4-350	12684	MXV5-960	165181	MXV4-390	754222	MXV4-440	
240773	MXV4-740	272242	MXV4-350	13072	MXV4-720	165182	MXV4-540	754223	MXV3-360	
245477	MXV4-840	359328	MXV4-500	13436	MXV4-540	165183	MXV4-570	754242	MXV4-320	
602956	MXV3-290	230272205	MXV4-400	13487	MXV4-350	165184	MXV4-550	754244	MXV4-400	
602957	MXV3-310	320272201	MXV4-510	14146	MXV4-390	170921	MXV4-240	754245	MXV4-590	
603682	MXV4-240	320272204	MXV4-380	14146	MXV4-390	173420	MXV5-930	754250	MXV4-530	
605711	MXV4-610	320272205	MXV4-400	14365	MXV4-510	173461	MXV4-1000	754252	MXV4-330	
605837	MXV4-1120	320272208	MXV4-470	14790	MXV4-380	173948	MXV4-570	754256	MXV3-290	
		320272213	MXV4-470	14843	MXV4-290	200413	MXV4-390	754257	MXV3-380	
		320272214	MXV4-750	16146	MXV4-390	200414	MXV4-830	754264	MXV4-520	

WARNING: These products can expose you to chemicals including carbon black which is known in the state of California to cause cancer, birth defects or other reproductive harm. For more information visit www.P65WARNINGS.ca.gov

LAWN AND GARDEN EQUIPMENT PART NUMBERS

NOTE: FHP Belt may be upgraded to the MXV Belt, however the FHP Belt SHOULD NOT be substituted for the MXV Belt

Alphabetical sequence by manufacturer

OEM #	Belt No.	OEM #	Belt No.	OEM #	Belt No.	OEM #	Belt No.	OEM #	Belt No.
754265	MXV4-350	L21P21290	MXV3-370	754-0114	MXV4-240	754-0214	MXV4-500	754-0327	MXV5-280
754267	MXV4-590	L5055	MXV3-220	754-0115	MXV5-610	754-0215	MXV4-1070	754-0328	MXV5-490
754273	MXV3-340	L5399	MXV3-210	754-0116	MXV4-420	754-0216	MXV3-290	754-0329	MXV5-690
754278	MXV4-300	S1A119	MXV4-330	754-0117	MXV4-320	754-0217	MXV5-790	754-0329A	MXV5-690
754285	MXV4-340	S1A164	MXV4-310	754-0118	MXV5-630	754-0218	MXV5-590	754-0330	MXV4-900
754292	MXV4-260	Y22	MXV4-300	754-0121	MXV4-310	754-0219	MXV4-260	754-0338	MXV4-770
754935	MXV4-310			754-0124	MXV4-570	754-0220	MXV5-270	754-0339	MXV4-790
754936	MXV4-470			754-0125	MXV4-1050	754-0221	MXV5-520	754-0340	MXV5-840
1008304	MXV3-370			754-0125A	MXV4-1050	754-0222	MXV4-440	754-0342	MXV4-670
1009102	MXV3-290	2492	MXV4-250	754-0126	MXV4-200	754-0223	MXV3-360	754-0343	MXV3-310
1020699	MXV3-270	1020699	MXV3-270	754-0127	MXV5-660	754-0224	MXV5-250	754-0344	MXV4-730
1108466	MXV4-330			754-0128	MXV5-350	754-0225	MXV4-1070	754-0346	MXV3-300
1540198	MXV4-620	102	MXV4-610	754-0129	MXV4-260	754-0226	MXV4-820	754-0347	MXV4-630
1651066	MXV4-640	186	MXV5-470	754-0131	MXV3-350	754-0227	MXV5-630	754-0348	MXV4-530
1714286	MXV4-480	P127	MXV4-250	754-0133	MXV3-320	754-0228	MXV5-620	754-0349	A77
1714513	MXV3-230	P322	MXV3-210	754-0134	MXV3-330	754-0229	MXV4-520	754-0350	MXV5-640
1723661	MXV3-410	P49	MXV5-580	754-0135	MXV4-340	754-0230	MXV4-560	754-0351	MXV4-610
7540104	MXV4-320	P50	MXV5-320	754-0136	MXV5-310	754-0231	MXV4-280	754-0352	MXV4-480
7540105	MXV4-300	P638	MXV5-390	754-0137	MXV4-300	754-0232	MXV4-200	754-0355	MXV4-670
7540107	MXV4-300			754-0138	MXV5-500	754-0233	MXV4-210	754-0364	MXV5-680
7540109	MXV4-430			754-0139	MXV3-380	754-0234	MXV4-410	754-0365	MXV4-830
7540112	MXV5-800	954-04285	MXV5-350	754-0140	MXV4-310	754-0235	MXV4-350	754-0367	MXV4-340
7540113	MXV5-480	6434	MXV5-510	754-0141	MXV5-520	754-0236	MXV4-850	754-0369	MXV3-330
7540114	MXV4-240	6511	MXV4-680	754-0142	MXV3-310	754-0238	MXV4-920	754-0370	MXV5-490
7540121	MXV4-310	8431	MXV5-670	754-0143	MXV3-280	754-0239	MXV4-290	754-0371	MXV5-740
7540136	MXV5-310	23144	MXV4-920	754-0144	MXV5-550	754-0240	MXV5-380	754-0371A	MXV5-740
7540138	MXV5-500	23145	MXV4-460	754-0145	MXV4-690	754-0241	MXV5-350	754-04001	MXV5-690
7540142	MXV3-310	249730	MXV3-360	754-0145A	MXV4-690	754-0241A	MXV5-350	754-04014	MXV3-270
7540143	MXV3-280	1651020	MXV4-180	754-0146	MXV4-330	754-0242	MXV4-320	754-04032	MXV3-360
7540144	MXV5-550	1731273	MXV4-350	754-0147	MXV5-520	754-0243	MXV4-460	754-04032A	MXV3-360
7540145	MXV5-690	106409C1	MXV4-860	754-0151	MXV5-670	754-0244	MXV4-400	754-04032B	MXV3-360
7540157	MXV5-280	106465C1	MXV4-510	754-0154	MXV4-350	754-0245	MXV4-590	754-04041	MXV5-1110
7540163	MXV4-280	106990C1	MXV4-450	754-0155	MXV3-400	754-0246	MXV4-590	754-04043	MXV4-580
7540167	MXV5-640	126496C1	MXV4-330	754-0157	MXV5-280	754-0247	MXV4-560	754-04048	MXV5-1300
7540173	MXV5-370	132013C1	MXV4-300	754-0158	MXV5-350	754-0248	MXV4-890	754-04060	MXV4-960
7540177	MXV4-320	132401C1	MXV4-690	754-0163	MXV4-280	754-0249	MXV5-300	754-04060B	MXV4-960
7540180	MXV5-540	132407C1	MXV4-690	754-0164	MXV4-630	754-0250	MXV4-530	754-04064	MXV5-680
7540182	MXV5-810	140080C1	MXV4-320	754-0165	MXV4-340	754-0251	MXV4-510	754-04074A	MXV4-780
7540185	MXV4-490	3766230R1	MXV3-310	754-0166	MXV5-620	754-0252	MXV4-330	754-04077	MXV5-1340
7540186	MXV4-820	386160R1	MXV3-300	754-0167	MXV5-640	754-0253	MXV4-430	754-04093	MXV3-350
7540188	MXV5-510	401960R1	MXV3-310	754-0169	MXV3-360	754-0254	A17A	754-04118	MXV5-1220
7540191	MXV4-650	408077R1	MXV4-480	754-0170	MXV5-500	754-0255	MXV4-370	754-04122	MXV4-900
7540195	MXV4-540	413462R4	MXV4-810	754-0171	MXV4-320	754-0256	MXV3-290	754-04137	MXV4-1140
7540198	MXV4-620	464351R1	MXV4-300	754-0173	MXV5-370	754-0257	MXV3-380	754-04142	MXV4-910
7540203	MXV5-610	471599R2	MXV4-770	754-0177	MXV4-320	754-0260	MXV5-510	754-04153	MXV4-1220
7540204	MXV4-670	473468R2	MXV4-720	754-0178	MXV5-820	754-0261	MXV4-560	754-04219	MXV4-1030
7540205	MXV3-320	477599R2	MXV4-770	754-0179	MXV5-500	754-0264	MXV4-520	754-04240	MXV4-1620
7540206	MXV4-500	481099R2	MXV4-830	754-0180	MXV5-540	754-0265	MXV4-290	754-0427	MXV5-710
7540207	MXV4-420	489399R1	MXV4-800	754-0181	MXV4-1000	754-0266	MXV4-850	754-0428	MXV4-420
7540208	MXV4-550	549108R1	MXV4-380	754-0182	MXV5-810	754-0267	MXV4-590	754-0429	MXV3-460
7540217	MXV5-790	549609R1	MXV4-500	754-0183	MXV5-290	754-0268	MXV5-510	754-0430	MXV3-350
7540219	MXV4-260	549822R1	MXV4-680	754-0184	MXV4-520	754-0269	MXV3-380	754-0432	MXV3-360
7540222	MXV4-440	579821R1	MXV4-310	754-0185	MXV4-490	754-0271	MXV3-390	754-0433	MXV5-690
7540223	MXV3-360	59701C1	MXV4-770	754-0186	MXV4-820	754-0273	MXV3-340	754-0434	MXV4-580
7540229	MXV4-520	59702C1	MXV4-850	754-0187	B22	754-0274	MXV4-440	754-0438	MXV4-510
7540242	MXV4-320	61083C1	MXV4-320	754-0188	MXV5-510	754-0275	MXV4-380	754-0439	MXV4-600
7540244	MXV4-400	61083CI	MXV4-320	754-0189	MXV4-440	754-0276	MXV4-480	754-0440	MXV4-990
7540245	MXV4-590	61083CI	MXV4-320	754-0190	MXV4-390	754-0277	MXV4-710	754-0441	MXV4-760
7540250	MXV4-530	61084C1	MXV4-590	754-0191	MXV4-650	754-0278	MXV4-300	754-0443	AA90
7540252	MXV4-330	61084CI	MXV4-590	754-0192	MXV4-340	754-0279	MXV5-650	754-0446	MXV5-450
7540256	MXV3-290	61084CI	MXV4-590	754-0193	MXV4-350	754-0280	MXV5-530	754-0453	MXV5-360
7540257	MXV3-380	706-15711	MXV4-350	754-0194	MXV4-450	754-0280A	MXV5-530	754-0455	MXV4-1030
7540265	MXV4-350	745-0267	MXV4-590	754-0195	MXV4-540	754-0281	MXV5-440	754-0456	MXV3-290
7540267	MXV4-590	751-0101A	MXV4-350	754-0196	MXV4-300	754-0282	MXV4-390	754-0461	MXV4-780
7540271	MXV3-390	754-0100	A16A	754-0197	A115	754-0283	MXV4-950	754-0465	MXV3-360
7540273	MXV3-340	754-0101	MXV3-350	754-0198	MXV4-620	754-0284	MXV5-410	754-0467	MXV5-910
7540278	MXV4-300	754-0101A	MXV3-350	754-0200	MXV4-480	754-0285	MXV4-340	754-0467A	MXV5-910
7540285	MXV4-340	754-0101B	MXV4-350	754-0201	MXV4-410	754-0287	MXV4-290	754-0468	MXV5-420
7540292	MXV4-260	754-0103	MXV4-270	754-0202	MXV4-850	754-0290	MXV4-470	754-0472	MXV5-830
7540936	MXV4-470	754-0104	MXV4-320	754-0203	MXV5-610	754-0291	MXV4-880	754-0474	MXV5-1020
8021077	MXV4-390	754-0105	MXV4-300	754-0204	MXV4-670	754-0292	MXV4-260	754-0475	MXV5-1090
8161244	MXV4-380	754-0106	MXV4-250	754-0205	MXV3-320	754-0293	MXV4-740	754-0476	MXV5-1000
54MA19	MXV4-350	754-0107	MXV4-300	754-0206	MXV4-500	754-0294	MXV4-890	754-0485	MXV5-970
EO27	MXV4-250	754-0108	MXV4-460	754-0207	MXV4-420	754-0295	MXV4-1110	754-0486	MXV5-670
L141029	MXV4-210	754-0109	MXV4-430	754-0210	MXV5-600	754-0299	MXV4-490	754-0486A	MXV5-670
L141038	MXV4-330	754-0111	MXV4-450	754-0211	MXV5-460	754-0325	MXV4-570	754-0497	MXV4-600
L19P21290	MXV3-350	754-0112	MXV5-800	754-0212	MXV5-450	754-0326	MXV4-620	754-0498	MXV4-670
L21P1290	MXV3-290	754-0113	MXV5-480	754-0213	MXV4-530	754-0326A	MXV4-620	754-0637	MXV3-310



WARNING: These products can expose you to chemicals including carbon black which is known in the state of California to cause cancer, birth defects or other reproductive harm. For more information visit www.P65WARNINGS.ca.gov

LAWN AND GARDEN EQUIPMENT PART NUMBERS

NOTE: FHP Belt may be upgraded to the MXV Belt, however the FHP Belt SHOULD NOT be substituted for the MXV Belt

Alphabetical sequence by manufacturer

OEM #	Belt No.	OEM #	Belt No.	OEM #	Belt No.	OEM #	Belt No.	OEM #	Belt No.
754-0637A	MXV3-310	954-0266	MXV4-850	A610	MXV5-310	45217	MXV4-390	314572	MXV4-800
754-0340	MXV5-840	954-0266A	MXV4-850	GW-1733439	MXV4-350	45509	MXV4-530	318372	MXV5-850
754-0642	MXV5-1380	954-0271	MXV3-390	GW-7540350	MXV5-640	46466	MXV5-830	319005	MXV5-810
754-0935	MXV4-310	954-0280	MXV5-530			47200	MXV4-290	320534	MXV4-740
754-0936	MXV4-470	954-0280A	MXV5-530			47201	MXV4-250	321147	MXV4-540
754-0937	MXV5-690	954-0281	MXV4-440			47390	MXV4-710	321206	MXV4-450
754-0938	MXV5-590	954-0293	MXV4-740			47611	MXV4-880	1501000	MXV4-900
754-1038	MXV5-500	954-0329A	MXV5-690	383	MXV4-240	48044	MXV5-820	1501001	MXV4-880
754-170	MXV5-500	954-0339A	MXV4-790	385	MXV4-480	48259	MXV3-450	1501105	MXV5-510
754-178	MXV5-820	954-0343	MXV3-310	958	MXV4-220	48529	MXV3-450	1501245	MXV4-870
754-184	MXV4-520	954-0346	MXV3-300	992	MXV4-230	48530	MXV3-430	90005938	MXV3-300
754-212	MXV5-470	954-0349	MXV4-790	2363	MXV4-440	49018	MXV5-840	511275M1	MXV4-1020
754-219A	MXV4-880	954-0350	MXV5-640	2543	MXV4-280	49045	MXV4-880	511277M2	MXV4-500
754-227	MXV5-630	954-0355	MXV4-670	3145	MXV3-230	49233	MXV3-440	511277M3	MXV4-500
754-244	MXV4-400	954-0363	MXV5-660	4231	MXV4-410	49405	MXV4-880	514132M1	MXV4-300
754-245	MXV4-590	954-0364	MXV5-680	8271	MXV4-250	49570	MXV4-350	514806M1	MXV4-350
754-264	MXV4-520	954-0367	MXV4-340	8597	MXV4-220	49580	MXV4-410	527711M1	MXV4-920
754-277	MXV4-710	954-0369	MXV3-330	8869	MXV4-330	49818	MXV5-840	L450	MXV4-500
754-3002	MXV4-720	954-0370	MXV5-490	20317	MXV4-200	49870	MXV5-840	L489	MXV4-890
754-3003	MXV5-890	954-0371	MXV5-740	20319	MXV4-200	50131	MXV4-840	LP2154	MXV4-200
754-3004	MXV4-780	954-0371A	MXV5-740	20368	MXV4-290	50137	MXV4-840	LP383	MXV4-240
754-3006	MXV5-930	954-04001A	MXV5-690	20582	MXV4-430	50170	MXV5-750	LP708	MXV5-380
754-3007	MXV4-590	954-04014	MXV3-270	20998	MXV4-420	50272	MXV4-350	PA8271	MXV4-250
754-3012	MXV4-320	954-04032	MXV3-360	21865	MXV4-260	50307	MXV3-280	PA8408	MXV4-220
754-3018	MXV4-860	954-04032A	MXV3-360	23164	MXV4-250	50591	MXV4-300	RM2543	MXV4-280
754-3021	MXV4-910	954-04032B	MXV3-360	24551	MXV4-250	50597	MXV4-300	RP8094	MXV4-240
754-3023	MXV5-940	954-04033	MXV4-1180	24829	MXV4-300	50731	MXV4-840	RP8095	MXV4-250
754-3024	MXV4-910	954-04041	MXV5-1110	25807	MXV5-330	50737	MXV4-840	RP8096	MXV4-260
754-3025	MXV4-900	954-04043	MXV4-570	25812	A17A	50754	MXV4-650	SP149	A16A
754-3026	MXV4-600	954-04043A	MXV4-570	25883	MXV5-430	50755	MXV4-380		
754-3027	MXV4-860	954-04045	MXV4-1090	26659	MXV5-720	50834	MXV4-300		
754-3029	MXV4-590	954-04048	MXV5-1300	27323	MXV4-410	50876	MXV3-380		
754-3035	MXV4-900	954-04060	MXV4-960	28148	MXV4-260	50877	MXV3-410	20556	MXV4-480
754-3036	MXV4-630	954-04064	MXV5-680	28165	MXV4-260	50935	MXV5-770	20558	MXV4-640
754-3037	MXV4-800	954-04074A	MXV4-780	28594	MXV4-350	51214	MXV4-850	105340	MXV5-960
754-3038	MXV4-610	954-04077	MXV5-1340	29198	MXV4-250	51458	MXV4-390	241749	MXV4-410
754-3050	MXV4-660	954-04118	MXV4-1220	29281	MXV5-750	51855	MXV4-410	241750	MXV4-310
754-3053	MXV4-1070	954-04122	MXV4-900	29454	MXV4-880	51865	MXV4-260	248940	MXV3-330
754-3066	MXV5-620	954-04142	MXV4-910	29798	MXV4-250	52450	MXV3-290		
754-342	MXV4-680	954-04165	MXV4-780	30839	MXV5-730	52467	MXV4-870		
754-4001A	MXV5-690	954-04176A	AX32	30997	MXV4-470	52714	MXV4-850		
754-4045	MXV4-1090	954-04219	MXV4-1030	30998	MXV4-420	52842	MXV4-960	532120302	MXV4-900
754-4048	MXV5-1310	954-04240	MXV4-1630	31053	MXV4-250	53162	MXV4-500	532140910	MXV4-780
754-4062	MXV4-780	954-04259A	MXV4-340	32131	MXV4-390	53301	MXV3-430	532408007	MXV5-380
754-4064	MXV5-680	954-0427	MXV5-710	32132	MXV4-390	53307	MXV3-430	532427304	MXV4-370
942-04062	MXV4-770	954-04285	MXV5-350	32668	MXV4-330	53363	MXV4-690	532437261	MXV4-290
954-0016	MXV5-830	954-0430	MXV3-350	32986	MXV5-820	53443	MXV3-340	539117245	MXV5-1220
954-0101A	MXV3-350	954-0430A	MXV3-350	36607	MXV5-630	53499	MXV4-300	532083691	MXV3-350
954-0109	MXV4-430	954-0430B	MXV3-350	39454	MXV4-880	53790	MXV3-370	532106085	MXV4-790
954-0111	MXV4-450	954-0432	MXV3-360	39455	MXV4-630	53833	MXV4-810	532110883	MXV4-990
954-0114	MXV4-240	954-0433	MXV5-690	39456	MXV5-690	54758	MXV4-820	532110884	MXV4-940
954-0125	MXV4-1050	954-0434	MXV4-580	40899	MXV4-350	54758	MXV4-820	532123461	MXV4-810
954-0131	MXV3-350	954-0439	MXV4-600	41200	MXV4-200	54830	MXV4-710	532123796	MXV4-950
954-0138	MXV5-500	954-0440	MXV4-990	41390	MXV4-710	55442	MXV4-580	532123796	MXV4-950
954-0145	MXV4-690	954-0441	MXV4-760	41405	MXV4-350	55450	MXV4-420	532124293	MXV4-800
954-0145A	MXV4-690	954-0446	MXV5-450	41505	MXV4-350	55914	MXV3-310	532124525	MXV4-890
954-0151	MXV5-670	954-0453	MXV5-360	41740	MXV4-380	57556	MXV4-890	532131264	MXV4-790
954-0155	MXV3-400	954-0456	MXV3-290	42035	MXV3-400	58110	MXV5-750	532137078	MXV3-320
954-0177	MXV4-320	954-0461	MXV4-780	42035	MXV3-400	72046	MXV3-310	532139573	MXV4-840
954-0178	MXV5-820	954-0465	MXV3-360	42111	MXV5-700	72106	MXV3-370	532140067	MXV4-830
954-0180	MXV5-540	954-0467	MXV5-910	42132	MXV4-350	72106	MXV3-370	532141416	MXV4-840
954-0181	MXV4-990	954-0467A	MXV5-910	42846	MXV4-500	72119	MXV4-300	532144200	MXV4-890
954-0194	MXV4-450	954-0467A	MXV5-910	42858	MXV4-390	72126	MXV3-360	532419271	144200
954-0197	MXV4-1170	954-0468	MXV5-420	42881	MXV5-710	72127	MXV3-410	532419744	A32
954-0198	MXV4-620	954-0472	MXV5-830	43066	MXV5-710	88690	MXV4-330	539114557	MXV5-1540
954-0201	MXV4-410	954-0474	MXV5-1020	43124	MXV4-290	300149	MXV4-470		
954-0216	MXV3-290	954-0476	MXV5-1000	43919	MXV4-560	300515	MXV4-340		
954-0224	MXV5-250	954-0483	MXV3-380	43979	MXV4-560	300600	MXV5-780		
954-0225	MXV4-1070	954-0485	MXV5-970	44039	MXV4-440	300650	MXV5-780		
954-0226	MXV4-820	954-0486	MXV5-670	44148	MXV4-630	300741	MXV4-690		
954-0228	MXV5-620	954-0486A	MXV5-670	44150	MXV4-410	300747	MXV4-690		
954-0230	MXV4-560	954-0497	MXV4-600	44190	MXV4-320	300842	MXV5-790		
954-0234	MXV4-410	954-0498	MXV4-670	44264	MXV4-980	302291	MXV5-640		
954-0240	MXV5-380	954-0637	MXV3-310	44313	MXV4-520	302719	MXV4-910		
954-0241	MXV5-350	954-0935	MXV4-310	45106	MXV4-630	305184	MXV5-830		
954-0241A	MXV5-350	954-4045	MXV4-1090	45181	MXV4-440	305667	MXV5-760		
954-0255	MXV4-370	954-4048	MXV5-1310	45186	MXV4-630	305698	MXV4-730		
954-0264	MXV4-520	954-4062	MXV4-780	45187	MXV4-440	309715	MXV4-440		
		954-4064	MXV5-680	45216	MXV4-430	314108	MXV5-850		
						314120	MXV4-870		

WARNING: These products can expose you to chemicals including carbon black which is known in the state of California to cause cancer, birth defects or other reproductive harm. For more information visit www.P65WARNINGS.ca.gov

CROSS-REFERENCE - LAWN & GARDEN

LAWN AND GARDEN EQUIPMENT PART NUMBERS

NOTE: FHP Belt may be upgraded to the MXV Belt, however the FHP Belt SHOULD NOT be substituted for the MXV Belt

Alphabetical sequence by manufacturer

OEM #	Belt No.	OEM #	Belt No.	OEM #	Belt No.	OEM #	Belt No.	OEM #	Belt No.		
7540104	MXV4-320	483518	MXV5-930	172066	MXV5-290	2108099	MXV4-440	2121216SM	MXV4-380		
7540109	MXV4-430	483741	MXV5-1370	172420	MXV4-930	2108209	MXV4-820	2121398SM	MXV3-330		
7540118	MXV5-630	483969	MXV4-860	172929	MXV3-330	2108300	MXV4-420	2154273SM	MXV5-420		
7540121	MXV4-310	484088	MXV5-1520	173461	MXV4-1000	2108450	MXV4-850	2156120SM	MXV4-630		
7540124	MXV4-570	484159	MXV5-770	173948	MXV4-570	2118068	MXV4-340	2158573SM	MXV4-310		
7540127	MXV5-660	484372	MXV5-830	174224	MXV4-660	2118488	MXV3-340	2161098SM	MXV4-390		
7540128	MXV5-350	48202A	48202	174364	MXV4-490	2121228	MXV4-370	2165048SM	MXV4-850		
7540937	MXV5-590	483012	MXV5-520	174486	MXV5-490	2158389	MXV4-290	2168171SM	MXV3-480		
ROOF		A48081	MXV5-800	174687	MXV4-730	2163011	MXV4-720	2170164SM	MXV4-770		
		A48083	MXV5-890	174731	MXV4-530	2172420	MXV4-930	2170771SM	MXV3-360		
		A48286	MXV5-930	174883	MXV4-340	174687	MXV4-730	2170921SM	MXV4-240		
426	MXV4-560	SIMPLICITY		174911	MXV4-440	16907967	MXV4-520	2172444SM	MXV4-1160		
428	MXV5-710			175361	MXV4-290	1601672SM	MXV4-610	2174364SM	MXV4-490		
430	MXV5-620			175439	MXV4-740	1607967SM	MXV4-520	2174911SM	MXV4-860		
431	MXV4-340	101136	MXV4-640	176393	MXV3-370	1608954SM	MXV4-330	2175361SM	MXV4-290		
452	MXV5-450	101137	MXV4-680	176439	MXV4-740	1610-98	MXV4-900	2176439SM	MXV4-740		
512	MXV4-290	105067	MXV5-510	176917	MXV4-350	1650502SM	MXV4-460	2176917SM	MXV4-370		
1350	MXV5-1000	105115	MXV4-620	177126	MXV4-790	1656960SM	MXV4-840	2177452SM	MXV4-620		
1351	MXV5-570	105122	MXV5-560	177452	MXV4-620	1657044SM	MXV4-930	5022148SM	MXV5-1500		
SCAG		105280	MXV5-640	1601672	MXV4-610	1664457SM	MXV4-410	5022667SM	MXV5-1390		
		48081	MXV5-800	105287	MXV5-880	1607813	MXV4-930	1664644SM	MXV4-1030	5023256SM	MXV4-1510
		48083	MXV5-890	105340	MXV5-960	1608954	MXV4-350	1664789SM	MXV4-890	5023297SM	MXV5-1470
48085	MXV4-380	106055	MXV5-580	1608957	MXV4-490	1664946SM	MXV4-570	5023496SM	MXV5-1420		
48087	MXV5-530	106390	MXV4-360	1608960	MXV4-350	1665024SM	MXV4-540	5102145YP	MXV4-1450		
48088	MXV5-1030	106689	MXV4-550	1615005	MXV4-400	1665706SM	MXV4-390	5103391YP	MXV5-1760		
48089	MXV5-890	106723	MXV4-790	1651201	MXV4-730	1666654SM	MXV3-320	8161244	MXV4-380		
48203	MXV4-400	106769	MXV4-560	1655069	MXV4-910	1666655SM	MXV4-410	LM-16029-69	MXV4-800		
48204	MXV5-820	108099	MXV4-440	1656655	MXV4-410	1668066SM	MXV4-1200	LM-16079-67	MXV4-520		
48207	MXV5-860	108151	MXV4-630	1657806	MXV4-360	1669394SM	MXV5-500	LM-80210-77	MXV4-390		
48265	MXV5-630	108175	MXV4-560	1663009	MXV3-280	1669937SM	MXV5-540	SSA101	SPA850		
48278	MXV5-780	108248	MXV4-480	1664457	MXV4-410	1672732SM	MXV3-310	SNAPPER			
48285	MXV5-560	108389	MXV4-990	1664644	MXV4-1020	1674308SM	MXV4-370				
48286	MXV5-930	108407	MXV4-470	1664946	MXV4-570	1674312SM	MXV4-370				
48295	MXV5-680	108458	MXV4-450	1665450	MXV4-870	1674898SM	MXV5-500	10034	MXV4-290		
48344	MXV4-350	109061	MXV4-280	1665666	MXV5-770	1674899SM	MXV5-560	10056	MXV4-250		
48359	MXV5-940	114224	MXV4-660	1665706	MXV4-390	1675704SM	MXV3-340	10108	MXV4-240		
48472	MXV4-530	118068	MXV4-340	1666324	MXV4-690	1676460SM	MXV4-430	10109	MXV4-400		
48530	MXV5-1030	118225	MXV4-250	1666654	MXV3-320	1676461SM	MXV4-330	10419	MXV4-260		
48553	MXV5-500	118312	MXV4-340	1666655	MXV4-410	1678354SM	MXV4-420	10467	MXV4-340		
48581	MXV4-570	118494	MXV3-340	1666801	MXV4-800	1678600SM	MXV3-630	10678	MXV4-680		
48587	MXV4-570	121078	MXV4-350	1667200	MXV4-340	1700415SM	MXV3-320	10708	MXV4-450		
48749	MXV4-580	121216	MXV4-380	1667506	MXV4-390	1701257SM	MXV4-420	10729	MXV4-430		
48760	MXV4-610	121228	MXV4-310	1668065	MXV4-690	1703371SM	MXV4-1450	10747	MXV4-560		
48799	MXV5-1150	121398	MXV4-430	1669394	MXV5-500	1703372SM	MXV4-1450	10748	MXV4-340		
48912	MXV5-1170	122039	MXV3-320	1669937	MXV5-540	1703466SM	MXV4-1260	10836	MXV3-390		
48996	MXV5-1350	122060	MXV3-360	1671788	MXV3-460	1703836SM	MXV4-910	10849	MXV3-250		
481557	MXV5-1230	122069	MXV4-530	1672732	MXV3-310	1707381SM	MXV4-860	10851	MXV4-440		
481558	MXV5-1400	122120	MXV3-340	1673667	MXV4-950	1707740SM	MXV4-690	11946	MXV4-280		
481749	MXV4-590	122146	MXV3-380	1674308	MXV4-850	1711777SM	MXV4-1170	11948	MXV4-300		
481880	MXV5-860	123073	MXV4-910	1674312	MXV4-350	1712481SM	MXV4-600	11969	MXV4-510		
481980	MXV5-1620	124025	MXV4-300	1674898	MXV5-500	1712482SM	MXV4-780	12020	MXV4-350		
482009	MXV4-520	147883	MXV4-340	1674899	MXV5-560	1712595SM	BX108	12025	MXV4-450		
482090	MXV5-1070	152017	MXV5-450	1676460	MXV4-430	1712596SM	AX120	12248	MXV4-250		
482091	MXV5-530	153091	MXV4-440	1676461	MXV3-330	1712937SM	AX110	12249	MXV4-350		
482138	MXV5-500	154273	MXV5-420	1678354	MXV4-420	1713515SM	MXV4-780	12508	MXV3-240		
482140	MXV5-550	154307	MXV4-350	1679915	MXV3-390	1715127SM	MXV4-350	12524	MXV5-900		
482171	MXV4-600	155307	MXV4-350	1700415	MXV3-320	1715128SM	MXV4-360	12561	MXV4-540		
482281	MXV5-1210	156120	MXV4-630	1701257	MXV4-420	1715591SM	MXV3-340	13436	MXV4-540		
482529	MXV5-1480	156231	MXV4-420	1705563	MXV4-740	1717393SM	MXV4-360	13936	MXV3-380		
482530	MXV5-1550	157230	MXV3-220	1707381	MXV4-860	1718017SM	MXV4-1140	13937	MXV4-390		
482652	MXV5-1760	157424	MXV3-390	1707740	MXV4-690	1719233SM	MXV4-1140	13938	MXV3-370		
482716	MXV4-610	157524	MXV3-390	2025341	MXV4-440	1720234SM	MXV4-1140	14225	MXV4-1000		
482876	BX41	157683	MXV4-290	2025364	MXV4-820	1720402SM	MXV4-1140	14353	MXV4-620		
483001	MXV5-1320	158389	MXV4-290	2025463	MXV4-530	1721532SM	MXV4-830	14560	MXV4-990		
483002	MXV5-1490	158460	MXV4-310	2025492	MXV5-450	1723391SM	MXV4-820	14637	MXV3-330		
483084	BX62	158573	MXV4-310	2025641	MXV5-420	1725371SM	MXV3-320	14716	MXV4-360		
483157	BX62	161098	MXV4-390	2025712	MXV5-490	1725416SM	MXV4-430	14717	MXV4-390		
483165	BX77	161146	MXV4-340	2029350	MXV4-530	1728008SM	MXV4-890	14801	MXV4-940		
483166	BX78	162081	MXV4-760	2029665	MXV4-1000	1732086SM	MXV4-890	15151	MXV4-340		
483172	BX63	164146	MXV4-340	2029748	MXV4-340	1732249SM	MXV4-420	15152	MXV4-350		
483239	BX47	165048	MXV4-850	2029789	MXV4-340	1733324SM	MXV3-330	15757	MXV5-690		
483240	BX52	165806	MXV4-360	2029828	MXV3-370	1734114SM	MXV4-700	19534	MXV4-350		
483241	MXV5-1170	166172	MXV4-470	2029829	MXV4-350	1737220YP	MXV4-1320	19551	MXV4-430		
483242	MXV5-1250	166570	MXV4-390	2087648	MXV4-720	1753941YP	MXV4-440	19581	MXV4-960		
483243	MXV5-1350	167031	MXV4-830	2087732	MXV4-780	1753942YP	MXV4-440	19607	MXV4-390		
483314	AX79	170164	MXV4-770	2087759	MXV4-660	2108248SM	MXV4-480	20560	MXV4-500		
483325	MXV5-1410	170771	MXV4-360	2087836	MXV4-740	2108458SM	MXV4-480	21354	MXV4-220		
483326	MXV5-1480	170921	MXV4-240	2087883	MXV3-340	2121078SM	MXV4-480	23226	MXV4-310		
								23282	MXV4-350		



WARNING: These products can expose you to chemicals including carbon black which is known in the state of California to cause cancer, birth defects or other reproductive harm. For more information visit www.P65WARNINGS.ca.gov

LAWN AND GARDEN EQUIPMENT PART NUMBERS

NOTE: FHP Belt may be upgraded to the MXV Belt, however the FHP Belt SHOULD NOT be substituted for the MXV Belt

Alphabetical sequence by manufacturer

OEM #	Belt No.	OEM #	Belt No.	OEM #	Belt No.	OEM #	Belt No.	OEM #	Belt No.
29604	MXV3-330	9430	MXV4-360	106518	MXV4-870	269670	MXV4-400	119-8819	MXV4-1130
76085	MXV4-350	9431	MXV4-390	106523	MXV4-410	271100	MXV4-500	119-8820	MXV4-1410
76353	MXV5-850	9691	MXV4-700	106533	MXV4-400	271102	MXV5-850	119-8821	MXV4-810
76496	MXV5-890	9750	MXV5-690	106571	MXV4-800	271104	MXV4-380	1-603045	MXV4-1120
76497	MXV5-440	9782	MXV4-690	106751	MXV4-800	282650	MXV4-1020	17-0850	MXV4-400
76498	MXV5-360	9783	MXV4-710	107298	MXV4-720	285250	MXV4-530	19-2650	MXV4-370
76676	MXV5-520	10242	MXV4-770	107320	MXV4-600	362920	MXV4-610	23-9080	MXV4-400
76677	MXV5-940	13881	MXV4-290	107740	MXV4-630	368070	MXV3-340	26-9670	MXV4-400
76680	MXV5-360	27115	MXV4-360	107939	MXV5-830	411420	MXV4-660	26-9670-09	MXV4-400
76680	MXV5-940	27140	MXV4-290	108195	MXV4-670	420880	MXV4-230	26-9672	MXV4-300
76880	MXV5-370	27156	MXV4-340	108427	MXV4-880	420881	MXV4-220	27-0230	MXV4-400
77094	MXV4-290	27158	MXV4-340	108501	MXV5-820	420882	MXV4-220	3-7274	MXV3-320
79168	MXV4-960	27168	MXV5-430	108502	MXV5-830	420883	MXV4-240	51-3530	MXV4-510
79190	MXV5-1000	27173	MXV4-350	108503	MXV4-590	420885	MXV4-580	54-2750	MXV5-700
79196	MXV4-1070	27174	MXV4-340	108834	MXV4-980	499100	MXV3-400	54-2750-09	MXV5-700
79333	MXV5-570	27181	MXV4-390	109428	MXV4-760	512490	MXV4-530	5-4505	MXV3-320
222069	MXV3-240	27185	MXV4-500	110082	MXV4-480	513530	MXV4-510	88-6250	MXV4-870
2813861	MXV3-330	27191	MXV5-480	110141	MXV4-410	513600	MXV4-630	91-2258	MXV3-350
7012508	MXV3-240	27193	MXV4-610	110420	MXV4-480	541360	MXV4-490	99-4647	B143
7029604	MXV3-330	27195	MXV4-350	111710	MXV4-530	541380	MXV4-740	A43	MXV4-450
7076496	MXV5-890	27199	MXV4-610	111720	MXV4-530	541390	MXV4-560	A52	MXV4-540
7076497	MXV5-440	31182	MXV3-300	111730	MXV4-350	542751	MXV5-690	H0364	MXV4-330
7076498	MXV5-360	31560	MXV4-500	111740	MXV4-600	565570	MXV4-540	MW10366	MXV4-360
7076677	MXV5-940	31662	MXV4-230	113072	MXV4-1020	574750	MXV4-580	MW10367	MXV4-330
7076680	MXV5-360	31663	MXV3-270	113105	MXV4-330	576690	MXV4-820	MWJ0366	MXV4-360
7076680	MXV5-940	32733	MXV4-250	113141	MXV4-760	576990	MXV4-820	WW5403A	MXV5-290
	TORO/WHEEL	34577	MXV4-470	113288	MXV4-530	577000	MXV4-430		TROY-BILT
874	MXV5-770	34663	MXV3-280	113912	MXV4-440	623900	MXV3-350	9245	MXV4-220
1473	MXV4-320	36348	MXV4-430	114020	MXV4-480	944399	MXV5-740	20565	MXV4-240
1526	MXV4-220	36593	MXV4-410	114421	MXV4-530	1133303	MXV4-340	239661	MXV3-360
1550	MXV4-420	37274	MXV3-320	114433	MXV4-830	5770000	MXV4-430	1722095	MXV5-440
1552	MXV4-350	38093	MXV4-260	114567	MXV4-480	10-0230	MXV4-400	1751601	MXV3-310
1554	MXV4-240	38095	MXV4-340	114718	MXV4-460	10-3345	MXV3-250	1769767	MXV4-660
1555	MXV4-440	38166	MXV4-400	114833	MXV4-820	103-4761	AX51	1770334	MXV4-580
1561	MXV4-300	50104	MXV4-510	114860	MXV4-930	104-3126	MXV5-580	1813271	MXV4-550
1563	MXV4-390	51583	MXV4-240	114895	MXV5-830	104-3127	MXV5-580	1813561	MXV4-550
1569	MXV4-290	57000	MXV4-430	116160	MXV5-720	105-6963	MXV4-1410	1894272	MXV3-350
1576	MXV4-700	70073	MXV4-340	116183	MXV5-510	105-6977	MXV4-1470	1894335	MXV3-360
1577	MXV4-280	70074	MXV3-310	116332	MXV5-650	105-7790	MXV5-2260	1902325	MXV5-290
1578	MXV3-370	70161	MXV4-600	116527	MXV4-430	105-8783	MXV5-2420	754-04003	MXV3-320
1580	MXV4-310	70162	MXV5-320	116666	MXV5-770	106-2173	MXV4-1170	754-04093	MXV3-350
1586	MXV4-760	70354	MXV4-330	116667	MXV4-850	106-2174	MXV4-280	754-04101	MXV3-310
1588	MXV4-590	70530	MXV3-350	118068	MXV4-340	106-6998	MXV4-1170	754-04107	MXV5-1350
1589	MXV4-570	70550	MXV3-270	118116	MXV3-360	106-7350	MXV5-2640	754-04142	MXV4-910
1595	MXV4-670	70551	MXV3-380	118225	MXV4-250	106-7369	MXV4-1060	754-04219	MXV4-1030
1596	MXV4-510	70657	MXV3-320	118312	MXV4-340	107-1735	MXV4-1320	754-04240	MXV4-1620
1597	MXV3-250	70694	MXV4-300	124180	MXV4-410	108-5915	MXV5-2020	754-0637A	MXV3-310
1599	MXV4-280	70737	MXV5-360	124780	MXV4-470	108-7190	MXV4-1450	954-04142	MXV4-910
2058	MXV4-300	70824	MXV4-310	126220	MXV4-330	105-7192	MXV4-1380	954-04165	MXV4-780
5950	MXV4-280	70827	MXV4-310	126420	MXV4-410	109-3388	MXV4-750	954-04176A	AX32
6489	MXV4-780	70946	MXV4-300	126430	MXV4-460	109-3661	MXV4-1540	954-04219	MXV4-1030
6506	MXV4-320	72166	MXV3-320	126520	MXV4-330	109-5364	MXV4-1460	954-04240	MXV4-1630
6551	MXV3-310	73476	MXV4-620	126550	MXV4-540	109-8069	MXV4-750	954-04259A	MXV4-340
6552	MXV3-300	73887	MXV4-290	128260	MXV4-450	110-6774	AX60	954-0456	MXV3-290
6573	MXV4-380	73888	MXV4-460	188890	MXV4-450	110-6871	MXV4-1120	954-05001	MXV4-430
6737	MXV4-690	73890	MXV4-450	192220	MXV4-440	110-6892	MXV4-1400	GW56035	MXV4-220
6738	MXV3-380	73975	MXV4-500	192790	MXV4-410	112-0301	MXV5-900	GW-9245	MXV4-220
6771	MXV4-710	74228	MXV4-480	196960	MXV4-350	112-0305	MXV5-420	T1769767	MXV4-660
6993	MXV4-220	74231	MXV4-330	200170	MXV4-530	112-0317	MXV4-790		WESTERN
7358	MXV4-660	74232	MXV4-710	200554	MXV4-460	112-0332	MXV5-1340	1110	MXV4-350
7430	MXV4-280	74233	MXV4-710	200555	MXV3-460	112-0933	MXV5-1370	1205	MXV4-220
7473	MXV5-820	76740	MXV4-430	205990	MXV3-500	112-5800	MXV4-1090	1210	MXV4-250
7776	MXV4-870	79160	MXV4-570	208527	MXV4-480	112-5834	MXV4-900	1212	MXV3-360
8005	MXV4-720	85660	MXV3-330	208626	MXV3-270	112-5951	MXV4-780	1216	MXV4-730
8133	MXV4-740	100129	MXV5-500	225360	MXV4-630	112-6147	MXV4-780	1218	MXV4-350
8160	MXV5-830	101137	MXV4-680	230220	MXV3-370	112-6171	MXV4-1220	1221	MXV3-260
8231	MXV4-700	102607	MXV4-890	239050	MXV4-400	114-0453	MXV4-1410	1227	MXV4-420
8334	MXV5-850	102743	MXV5-670	239080	MXV4-400	114-0454	MXV4-1480	1409	MXV5-520
8412	MXV4-860	102868	MXV4-1050	248940	MXV3-330	114-4420	MXV5-2020	1526	MXV4-220
8430	MXV4-590	103345	MXV3-250	249730	MXV3-360	114-5858	MXV5-1960	2227	MXV4-420
8677	MXV4-520	103522	MXV4-850	250105	MXV4-400	114-5859	MXV5-2190	2435	MXV4-350
8687	MXV4-520	104290	MXV4-290	250106	MXV3-460	115-2649	MXV4-1490	3660	MXV4-250
8911	MXV4-830	104388	MXV4-550	251028	MXV3-340	115-4971	MXV5-1800	4320	MXV4-340
8975	MXV4-580	104633	MXV4-360	258340	MXV3-330	115-4972	MXV5-1850	4638	MXV4-300
8976	MXV4-550	104865	MXV4-550	262770	MXV4-500	115-7407	MXV5-1750	6163	MXV3-370
9151	MXV5-960	105476	MXV4-800	263340	MXV4-330	115-7426	MXV5-1830	6184	MXV3-390
9360	MXV4-950	105477	MXV4-400	263540	MXV4-340	115-9613	MXV4-750	9304	MXV4-290
		106516	MXV4-830	269610	MXV4-400	117-9607	MXV4-1640		



WARNING: These products can expose you to chemicals including carbon black which is known in the state of California to cause cancer, birth defects or other reproductive harm. For more information visit www.P65WARNINGS.ca.gov

CROSS-REFERENCE - LAWN & GARDEN

LAWN AND GARDEN EQUIPMENT PART NUMBERS

NOTE: FHP Belt may be upgraded to the MXV Belt, however the FHP Belt SHOULD NOT be substituted for the MXV Belt

Alphabetical sequence by manufacturer

OEM #	Belt No.	OEM #	Belt No.	OEM #	Belt No.	OEM #	Belt No.	OEM #	Belt No.				
WESTERN		754151	MXV5-670	7540173	MXV5-370	754154	MXV4-350	7540219	MXV4-260				
9305	MXV4-520	754154	MXV4-350	7540177	MXV4-320	754165	MXV4-340	7540220	MXV5-270				
10755	MXV4-430	754157	MXV5-280	7540178	MXV5-820	754169	MXV3-360	7540221	MXV5-520				
10897	MXV4-510	754163	MXV4-280	7540179	MXV5-500	754181	MXV4-1000	7540222	MXV4-440				
10923	MXV4-300	754164	MXV4-630	7540180	MXV5-540	754189	MXV4-440	7540223	MXV3-360				
11144	MXV4-410	754165	MXV4-340	7540182	MXV5-810	754190	MXV4-390	7540224	MXV5-250				
13009	MXV4-410	754166	MXV5-620	7540183	MXV5-290	754195	MXV4-550	7540225	MXV4-820				
14790	MXV4-380	754169	MXV3-360	7540184	MXV4-520	754197	MXV4-1170	7540227	MXV5-630				
14843	MXV4-290	754173	MXV5-370	7540185	MXV4-490	754201	MXV4-410	7540229	MXV4-520				
16146	MXV4-390	754177	MXV4-320	7540188	MXV5-510	754204	MXV4-670	7540231	MXV4-280				
16149	MXV4-390	754178	MXV5-820	7540189	MXV4-440	754207	MXV4-420	7540234	MXV4-410				
16348	MXV4-380	754179	MXV5-500	7540191	MXV4-650	754208	MXV4-550	7540235	MXV4-350				
16366	MXV4-350	754180	MXV5-540	7540195	MXV4-540	754214	MXV4-500	7540236	MXV4-850				
16386	MXV4-400	754182	MXV5-810	7540196	MXV4-300	754220	MXV5-270	7540244	MXV4-400				
17569	MXV4-430	754183	MXV5-290	7540198	MXV4-620	754221	MXV5-520	7540245	MXV4-590				
18055	MXV4-300	754184	MXV4-520	7540200	MXV4-480	754222	MXV4-440	7540246	MXV4-590				
18263	MXV4-400	754185	MXV4-490	7540219	MXV4-260	754230	MXV4-560	7540247	MXV4-550				
20715	MXV4-310	754188	MXV5-510	7540229	MXV4-520	754231	MXV4-280	7540248	MXV4-890				
20716	MXV4-350	754189	MXV4-440	7540239	MXV4-290	754236	MXV4-590	7540249	MXV5-300				
20717	MXV4-560	754191	MXV4-650	7540242	MXV4-320	754250	MXV4-530	7540250	MXV4-530				
23645	MXV4-300	754195	MXV4-540	7540244	MXV4-400	754251	MXV4-510	7540251	MXV4-510				
26345	MXV4-300	754196	MXV4-300	7540245	MXV4-590	754254	MXV4-190	7540252	MXV4-330				
27093	MXV4-470	754198	MXV4-620	7540248	MXV4-890	754255	MXV4-350	7540253	MXV4-430				
33622	MXV3-260	754200	MXV4-480	7540255	MXV4-350	754256	MXV3-290	7540254	A17A				
35545	MXV4-400	754219	MXV4-260	7540936	MXV4-470	754260	MXV4-510	7540255	MXV4-350				
37169	MXV4-360	754239	MXV4-290	7540937	MXV5-590	754267	MXV4-590	7540256	MXV3-290				
37230	MXV4-380	754242	MXV4-320	60D56	MXV4-310	754268	MXV5-510	7540257	MXV3-380				
55019	MXV4-330	754244	MXV4-400	60D57	MXV4-300	754275	MXV4-380	7540260	MXV5-510				
57051	MXV4-540	754245	MXV4-590	754-0101	MXV3-350	1650120	A16A	7540261	MXV4-560				
200555	MXV3-460	754935	MXV4-310	P54239	MXV4-290	1651066	MXV4-640	7540267	MXV4-590				
200982	MXV4-780	754936	MXV4-470	P54242	MXV4-320	7540104	MXV4-320	7540268	MXV5-510				
200983	MXV4-780	754937	MXV5-590	YAMAHA				7540108	MXV4-460	7540271	MXV3-390		
208526	MXV3-380	7540103	MXV4-210					5511	MXV5-740	7540109	MXV4-430	7540274	MXV4-440
209581	MXV4-860	7540104	MXV4-320					7855521	MXV5-640	7540114	MXV4-240	7540275	MXV4-380
211650	MXV3-330	7540105	MXV4-300					7Y64624200	MXV5-320	7540125	MXV4-1050	7540278	MXV4-300
211664	MXV3-360	7540107	MXV4-300					7Y64624210	MXV5-330	7540136	MXV5-310	7540285	MXV4-340
216594	MXV4-1020	7540108	MXV4-460					LA85	MXV4-850	7540142	MXV3-310	7540290	MXV4-470
233163	MXV4-430	7540109	MXV4-430					LB103	MXV5-1030	7540143	MXV3-280	7540291	MXV4-880
754101	MXV4-350	7540111	MXV4-450					LB64	MXV5-650	7540144	MXV5-550	7540292	MXV4-260
754103	MXV4-250	7540112	MXV5-800					LB66	MXV5-660	7540145	MXV5-690	7540326	MXV4-620
754104	MXV4-320	7540113	MXV5-480					LB67	MXV5-680	7540146	MXV4-330	7540327	MXV5-280
754105	MXV4-300	7540114	MXV4-240	YARDMAN				7540154	MXV4-350	7540338	MXV4-770		
754107	MXV4-300	7540115	MXV5-610					2006	MXV4-280	7540165	MXV4-340	7540347	MXV4-630
754108	MXV4-460	7540116	MXV4-420					40041	MXV4-400	7540167	MXV5-640	7540365	MXV4-830
754109	MXV4-430	7540118	MXV5-630					40207	MXV4-450	7540169	MXV3-360	7540372	MXV4-810
754111	MXV4-450	7540121	MXV4-310					165120	A16A	7540177	MXV4-320	7540441	MXV4-760
754112	MXV5-800	7540124	MXV4-570					165143	MXV4-560	7540178	MXV5-820	7544154	MXV4-350
754113	MXV5-480	7540127	MXV5-660					165159	MXV4-580	7540185	MXV4-490	7651066	MXV4-640
754114	MXV4-240	7540134	MXV3-330					165160	MXV4-400	7540187	B22	16510666	MXV4-640
754115	MXV5-610	7540136	MXV5-310					165161	MXV5-610	7540188	MXV5-510	754-0101	MXV3-350
754116	MXV4-420	7540138	MXV5-500					165166	MXV4-640	7540189	MXV4-400	754-0101A	MXV3-350
754118	MXV5-630	7540139	MXV3-380	165168	MXV4-350	7540195	MXV4-540	7540373A	MXV5-730				
754121	MXV4-310	754109	MXV4-430	165176	MXV4-500	7540196	MXV4-300	754C142	MXV3-310				
754124	MXV4-570	754111	MXV4-450	165179	MXV5-780	7540198	MXV4-620	954-04259A	MXV4-340				
754127	MXV5-660	7540143	MXV3-280	165181	MXV4-390	7540200	MXV4-480						
754134	MXV3-330	7540144	MXV5-550	165183	MXV4-570	7540202	MXV4-410						
754136	MXV5-310	7540145	MXV5-690	540142	MXV3-310	7540204	MXV4-670						
754138	MXV5-500	7540146	MXV4-330	740255	MXV4-350	7540205	MXV3-320						
754139	MXV3-380	7540147	MXV5-520	754109	MXV4-430	7540206	MXV4-500						
754143	MXV3-280	7540154	MXV4-350	754136	MXV4-510	7540207	MXV4-420						
754144	MXV5-550	7540157	MXV5-280	754143	MXV3-280	7540208	MXV4-550						
754145	MXV5-690	7540163	MXV4-280	754144	MXV5-550	7540211	MXV5-450						
754146	MXV4-330	7540164	MXV4-630	754146	MXV4-330	7540212	MXV5-560						
754147	MXV5-520	7540165	MXV4-340			7540214	MXV4-500						
		7540166	MXV5-620			7540216	MXV3-290						
		7540169	MXV3-360			7540218	MXV5-590						

Jason MXV Series Belts are functional replacements to the printed OEM part numbers. Sizes may vary slightly from OEM belt, but are within RMA (Rubber Manufacturers Association) standards for the application.



WARNING: These products can expose you to chemicals including carbon black which is known in the state of California to cause cancer, birth defects or other reproductive harm. For more information visit www.P65WARNINGS.ca.gov

AG EQUIPMENT & PUMP BELTING PART NUMBERS

NOTE: FHP Belt may be upgraded to the MXV Belt, however the FHP Belt SHOULD NOT be substituted for the MXV Belt

Alphabetical sequence by manufacturer

OEM #	Belt No.	OEM #	Belt No.	OEM #	Belt No.	OEM #	Belt No.	OEM #	Belt No.
ACE PUMP		512679	C135	548871	A90	1125980	CC128	1197883	B88
		512751	C75	548874	B85	1125981	D93	1197895	A93
BAC-28-10	400J10	514112	B64	548875	BB75	1126118	B53	1300867	C190
BAC-28-10M	320J10	514908	D69	556244	D97	1126320	B85	1301859	B142(2)
BAC-28-10M-150	360J10	514909	C52	558323	B79	1126448	C223	1301877	A105
BAC-28-150	440J10	514910	C43	558567	BB112	1126587	B105	1302279	C290
BAC-28-8	400J8	515768	C96	559862	A90	1126732	C267	1302283	B234
BAC-28-8M	320J8	516796	C83	559863	A81	1127198	B178	1305090	C116
AG CHEMICAL		516800	B195	560162	B118	1127199	B182	1305993	C106
		516801	B120	560163	B114	1127553	C251	1305994	C119
9489	3VX800	516876	B38	560164	B73	1128379	B222	1306291	A110
94105	A68	516976	C83	560375	C66	1129967	B182	1306451	D148
ALLIS CHALMERS/ GLEEMER		517303	C81	561604	C85	1129986	C140	1308584	B195
		517444	C60	563619	A98	1130177	C81	1309150	B164(2)
		518463	B46	571100	A95	1130178	C113	1309571	A63
		518465	A48	573681	C72	1130314	D147	1309967	C165
34647	B100	518656	D98	577016	B68	1130442	C73	1310380	C113
48716	B75	519007	C128	577851	C78	1130754	B149	1311275	B131
69704	B81	519731	C126	577870	A94	1130979	B175	1312339	A107
86214	CX81	520140	B71	577921	B160	1131237	C233	1313396	C131
86971	CX81	520173	B175	584284	C69	1132108	D116	1313804	B82
108209	SPA2067	521078	B112	673606	CX81	1134654	C83	1316263	B173(2)
125980	C131	522034	B101	802120	C45	1135296	C160	1316714	C136
133672	C78	523202	B130	802168	C51	1135748	D72	1319657	BB112
163011	SPA1807	523693	B61	802171	C51	1136325	C251	1320449	B153(2)
165048	MXV4-850	525203	C134	802382	A42	1136630	C144	1321691	B87
174911	MXV4-440	525347	B46	802957	C39	1137310	C72	1322395	C83
243834	B83	525413	A62	802958	C39	1137520	D119	1322828	C130
248322	B75	525596	B117	803459	B43	1138949	D109	1322834	C122
248324	B105	525742	B81	803460	B46	1139622	C68	1324294	C134
248328	B100	525824	C162	803461	B46	1139962	C150	1324690	C119
248331	B144	526155	B87	803587	C47	1139964	C89	1324877	C131
248322	B180	526369	B87	803770	C105	1139965	C83	1324878	C132
248334	B83	526370	B87	804122	C104	1140441	A83	1325150	B126(2)
248337	B173	526806	B231	804201	C103	1140809	D115	1325847	C116
248338	B158	526842	B136	804302	C58	1140990	B229	1326253	B188
248339	B133	526899	B100	805114	C48	1140991	B186	1326830	C168
248342	C60	529192	B50	805120	C45	1140992	B175	1328523	C128
248346	C105	529433	B42	822940	A88	1141215	B158	1333673	C96
248347	C112	530022	C101	823092	B38	1142831	C257	1334659	C103
248351	C158	530798	A60	823358	A26	1144488	A90	1334919	B133
248352	C180	531099	C100	825924	B108	1146258	C142	1335475	C183
248353	C190	531693	C119	826274	3VX630	1159352	B133	1336199	C87
248354	C195	531694	C120	826275	5VX1000	1160836	B215	1336210	C61
248355	210	531740	C73	1105320	B124	11611949	C173	1336307	A57(2)
249008	B72	533400	C77	1109103	B46	1164353	A74	1337000	B94
249010	C173	534515	A56	1109660	B112	1165613	C131	1338949	D110
260328	A53	534565	B52	1109661	B97	1165927	D72	1339419	C124
313804	B82	534875	C85	1110659	B103	1170191	C131	1339768	C105
325847	C116	535127	C114	1112395	B105	1170932	A85	1339772	C142
339886	C83	535279	B70	1112834	B60	1171755	B68	1339886	C83
358134	B84	536516	A39	1113847	B43	1171756	B68	1344935	C83
501470	B53	538180	C110	1115318	C63	1171907	SPZ1637(2)	1346299	B210
501505	B240	538268	B180	1115320	B124	1172562	B256	1359681	B88(2)
501507	B173	539207	D104	1116031	CC134	1173472	C345	1500256	BB92
501510	B165	539525	B71	1116033	D124	1175713	B71(2)	1501511	C119
501511	C119	539648	B68	1116054	B207	1176312	A74	1502632	C108
501542	B60	539685	BB128	1116055	B160	1176400	B242	1504568	C55
502434	C104	539686	B40	1116528	B75	1176492	B73	1601238	MXV3-340
502435	B240	541718	C145	1116838	B87	1177597	C102	1601405	MXV4-400
502436	B171	542180	B98	1117049	D160	1177795	B74	1601672	MXV4-610
502437	B60	542517	B140	1117540	D158	1178226	C87	1601695	MXV4-430
502438	B85	542517	B141	1117717	C128	1178329	B162	1602157	MXV4-730
502439	B145	542800	C68	1117718	D128	1178442	C214	1602969	MXV4-480
503303	D75	543900	B90	1118003	C144	1179490	B122	1603075	MXV4-930
503304	B106	543920	C90	1118629	B51	1180125	B75	1604406	MXV4-830
503305	B180	546672	B85	1119006	B62	1183251	B75	1606190	A80
503307	A71	547078	BB136	1119007	B133	1183718	B78	1606261	A79
503308	A46	547116	B98	1121342	B69	1187282	B195	1607051	MXV4-700
506147	B210	547286	C137	1122494	C238	1187728	C104	1607812	MXV4-820
506148	B188	548081	D112	1123452	B80	1187779	C75(2)	1607813	MXV4-830
506482	B158	548860	B145	1124461	B52	1188075	B113(2)	1607889	A68
506552	B156	548861	B144	1125972	B79	1190749	A126	1607967	MXV4-520
506553	C60	548862	B106	1125974	D160	1190750	A118	1608957	MXV4-490
506910	CC144	548863	C124	1125976	C72	1190876	A106	1610577	MXV4-560
507965	B128	548866	B73	1125977	B124	1192282	C87	1610578	MXV4-250
509860	B58	548869	C100	1125978	D128	1194116	C156	1650352	3L610
511176	C128	548870	C81	1125979	B190	1197878	A57(2)	1650502	A44



WARNING: These products can expose you to chemicals including carbon black which is known in the state of California to cause cancer, birth defects or other reproductive harm. For more information visit www.P65WARNINGS.ca.gov

AG EQUIPMENT & PUMP BELTING PART NUMBERS

NOTE: FHP Belt may be upgraded to the MXV Belt, however the FHP Belt SHOULD NOT be substituted for the MXV Belt

Alphabetical sequence by manufacturer

OEM #	Belt No.	OEM #	Belt No.	OEM #	Belt No.	OEM #	Belt No.	OEM #	Belt No.
ALLIS CHALMERS/ GLEEMER		2029748	MXV4-340	70512751	C75	71112395	B105	71607812	A79
1655069	MXV4-910	2029789	MXV4-340	70514112	B64	71115320	B124	71607813	A81
1656960	A82	2029828	MXV3-370	70515768	C96	71116031	CC136	71607967	A50
1657044	A91	2029829	MXV4-350	70516796	C83	71116054	B210	71608957	A47
1657517	B103	2087732	MXV4-780	70516800	B195	71116528	B75	71656960	A82
1664457	MXV4-410	2087759	MXV4-660	70516801	B120	71117540	D158	71657517	B103
1664644	MXV4-1020	2087778	MXV4-660	70516876	B38	71118003	C144	71664457	A39
1664789	A87	2087836	MXV4-740	70517303	C81	71118629	B51	71665450	A85
1665024	A53	2087855	A108	70517444	C60	71119006	B61	71665638	A124
1665450	MXV4-870	2087883	MXV3-340	70518465	A48	71122494	C240	71665646	AX120
1665706	MXV4-390	2107357	A202	70519007	C128	71123452	B79	71666801	A78
1666324	MXV4-690	4321275	C659(2)	70519731	C124	71125976	C72	72025309	A33
1666698	A88	4334717	CX81	70519838	B150	71125977	B124	72025341	A42
1666801	MXV4-800	4341456	C78(2)	70520140	B71	71125978	D128	72025364	A80
1667200	MXV4-340	4345997	CX68(3)	70521078	B112	71125979	B190	72025492	B42
1668066	A120	4345998	CX68(5)	70523693	B61	71125980	CC128	72025893	A46
1669471	A103	4361055	D180	70525347	B46	71126118	B53	72026081	A34
1669937	MXV5-540	4365306	B75(4)	70525413	A62	71126320	B85	72026270	A35
1671076	A96	4367875	CX68(3)	70525596	B116	71126587	B105	72026499	A53
2025236	B53	4372426	C78(5)	70526274	3V630(2)	71126732	C270	72026574	A61
2025309	A33	4373556	B70	70526842	B136	71128379	B225	72026755	A37
2025341	MXV4-440	4373792	CX68(2)	70526898	C89	71130178	C113	72027121	A43
2025364	MXV4-820	4373895	CX81(2)	70526899	B100	71130754	B148	72027134	A68
2025431	3L360	4373896	CX51(3)	70529192	B50	71134654	C83	72027145	A62
2025436	A24	4460270	C78(3)	70529433	B53	71135748	D72	72027168	A32
2025461	MXV3-360	4502933	B62	70530022	C100	71139622	C69	72027197	A54
2025463	MXV4-530	4611263	CX51	70530798	A60	71139949	D110	72029622	A68
2025492	MXV5-450	4611834	C85	70531694	C120	71139964	C89	74315811	C96(4)
2025641	MXV5-490	4613093	C180	70533400	C77	71139965	C83	74321275	C64
2025663	MXV4-350	4613878	C85(3)	70534515	A56	71140441	A83	74616609	B70
2025712	MXV5-490	4613879	C85(5)	70534565	B52	71144488	A90	76029441	B55
2025879	MXV4-630	4616609	B70	70534875	C85	71161949	C173	705803461	B46(2)
2025893	MXV4-480	4616616	B75	70535279	B70	71164353	A74	1345800-8	C172
2026066	MXV3-380	4616621	B78	70538180	C109(3)	71165927	D72	1347560-6	B217
2026081	MXV4-360	4616623	C78	70539525	B71	71170191	C131	1354210-8	C80
2026266	MXV4-380	4616624	C78	70539685	BB128	71175713	B71(2)	1359681-5	B89
2026268	MXV4-390	4616628	C81	70539686	B40	71176312	A74	4330160-3	B92
2026270	MXV4-350	4616629	C90	70541718	C144	71176400	B242	533400-8	C76
2026324	MXV4-910	4616632	C96	70542517	B140	71176492	B73	53BHx4	B128
2026378	MXV3-220	4616633	C97	70543900	B90	71178329	B162	548870-05	C81
2026499	MXV4-550	4616636	C105	70543920	C90	71187779	C75	548870-05	C81
2026574	A61	4661816	C81(3)	70546672	B85	71190749	A128	70515768A	C96
2026755	MXV4-390	4662969	C68(3)	70547078	BB136	71190750	A120	70516876A	B38
2027102	MXV4-610	4670739	B100(5)	70547286	C136	71194116	C156	70519007A	C128
2027121	MXV4-450	4671445	C90(3)	70548860	B144	71197878	A57	70531694A	C120
2027134	MXV4-700	4672404	C105(3)	70548861	B144	71306291	A110	70548869A	C99(2)
2027145	A62	6029441	B55	70548862	B106	71309571	A63	70577016A	B68
2027155	B61	8253359	B58	70548863	C124	71324877	C131	71112395A	B105
2027168	MXV4-340	70248322	B75	70548966	B73	71325847	C116	71115320A	B124
2027179	A54	70248324	B105	70548869	C39(2)	71333673	C96	71178329A	B162
2027569	A66	70248328	B100	70548870	C81	71334919	B133	71340653-6	BX88
2027581	MXV4-470	70248331	B144	70548871	A90	71337000	B94	71354210-8	C83
2027624	MXV5-960	70248332	B180	70548874	B85	71339886	C83	71502632A	C108
2027639	MXV5-880	70248334	B83	70548875	BB75	71340653	B87	9B00	B90
2027648	A81	70248337	B173	70558323	B79(5)	71345785	A64		
2027709	A27	70248338	B158	70559862	A90	71347560	B218		
2028035	MXV4-850	70248339	B133	70560162	B118	71347561	B133		
2028077	3L300	70248342	C60	70560375	C66	71351992	C81		
2028241	MXV4-310	70248346	C105	70573681	C72	71355170	B214		
2028474	MXV4-490	70248347	C112	70577016	B68	71356409	C103(2)		
2028549	MXV4-240	70248351	C158	70577851	C78	71358134	MXV5-870		
2028727	A114	70248352	C180	70577870	A94	71359598	C130		
2028766	MXV4-930	70248353	C190	70584284	C68	71359681	B88(2)		
2028988	MXV5-490	70248354	C195	70602944	B55	71363968	C131		
2029056	MXV4-570	70248355	C210	70675228	C83(2)	71364155	C175		
2029223	MXV4-440	70249009	B68	70675233	B42(3)	71364922	C81		
2029348	MXV4-350	70249010	C173	70802171	C51	71367459	C91		
2029350	MXV4-530	70298347	C112	70803460	B46(2)	71367460	CC98		
2029451	A27	70501470	B53	70803461	B46(2)	71374306	C176		
2029582	A133	70501511	C120	70803770	C105	71381995	C143		
2029622	MXV4-700	70502435	B240	70804201	C103	71388712	C210		
2029660	MXV4-620	70502436	B173	70805114	C48	71502632	C108		
2029665	MXV4-1000	70502438	B85	70805120	C45	71601524	A76		
		70503304	B105	70822940	A38	71602157	A71		
		70506148	B190	70823358	A26	71602969	A46		
		70507965	B128	70825924	B108(2)	71603075	A90		
		70509860	B58	70826274	3V630	71606190	A80		
		70511176	C128	70826275	5V1000	71607051	A68		

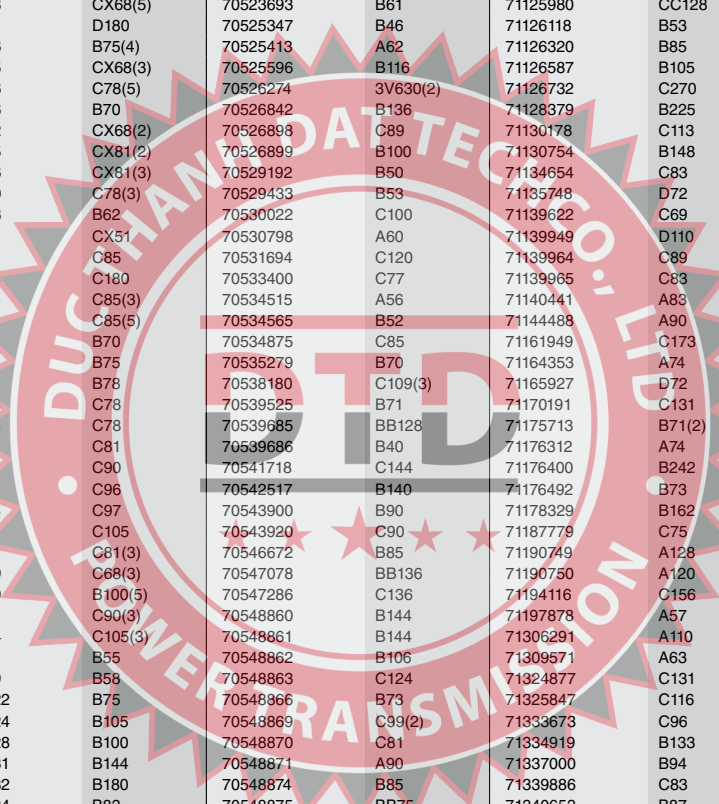

OEM #	Belt No.
ALLOWAY	
B144	B144
B162	B162
B192	B192
C105	C105
C112	C112
C128	C128
C144	C144
C158	C158
C162	C162
C173	C173
C180	C180
C195	C195
C210	C210
C225	C225
C240	C240
C255	C255
C270	C270
C300	C300
C330	C330
C360	C360

WARNING: These products can expose you to chemicals including carbon black which is known in the state of California to cause cancer, birth defects or other reproductive harm. For more information visit www.P65WARNINGS.ca.gov

AG EQUIPMENT & PUMP BELTING PART NUMBERS

NOTE: FHP Belt may be upgraded to the MXV Belt, however the FHP Belt SHOULD NOT be substituted for the MXV Belt

Alphabetical sequence by manufacturer

OEM #	Belt No.	OEM #	Belt No.	OEM #	Belt No.	OEM #	Belt No.	OEM #	Belt No.
ANTHES WEST		4899	B116	60007	B55	C C I L		20016	C51
0024A	C90	5161	B120	60008	B38	44	B35	23393	A112
005A	C185	5172	B136	97003825	C78(2)	45	C112	30236	A26
0952A	C90	5360	BX120	BRANDT		144	B35	31295	C272
APPLEQUIST		6738	C78(2)	28FT	B195	145	C112	31349	C79
YYB010	B108	4793A	B100	31FT	B210	892	B42	31808	C112
ARBOS ITALY		S1000	B61	35FT	B173	893	B51	32804	B62
33379	5VX1000	BADGER NORTHLAND		35FT2	B195	894	B144	32806	B38
33380	5VX630	606852	C115(2)	40FT1	B225(2)	895	C57	37746	A29
A30106	5V1800	B68	B68	40FT2	B225	896	C120	38401	B270
ARTS WAY		BALZER		45FT	B225(2)	1554	MXV4-240	38402	B240
5460	5VX750(8)	7157	C120(2)	ALL DRIVE	B195	1782	B62(4)	38404	B90
21131	B53	7443	C96	BRILLION IRON		1787	B57	38434	C294
21314	3L540	8153	C85	1D601	A105	1815	A75	38452	B64
21361	3VX800(12)	BARRANTINE		BROWN		1816	B48	38454	B95
21390	3VX600(2)	SM58	C128	111	C128	1892	B42	38456	B49
21487	3L460	BEAR CAT		211	C128	1893	B51	38457	C133
22835	B82	1AB60A	B60(4)	3E2O3	A82	2381	C60	38498	C136
23588	3V600	1AB81A	B81(5)	5D331	C75	2605	B75	38500	C255
73500	A76	2AB55	B55(4)	BUSH HOG		2818	C57	38501	C134
204925	B59	2AB71	B71	918	B144	2819	C120(4)	38504	C132
40207350	B76	7A53	B53	12727	B162	2960	B158	41186	B147
71336199	C86	8007B	B79	12728	B158	2930	B75	54896	C120
302124860	A46	AF162.R.58	1922V484	12730	B124	2981	B71	132804	B62
117004C1	C90	AS24P79A	BB35(2)	12731	B100	3170	B53	230054	C66
1253324C1	C86	ASFG216P	B83	84303	B118	3372	B56	542819	C128
23898K	B59	ASFG757P	B95	84305	B118	3555	B100	545222	C158
425A	3V800	ASGM597P	A46(2)	88655	A150	5184	C173(3)	5410283	C76(2)
57034C1	C77(3)	GM144P	B75	150030	B100(4)	5187	B85	5412449	C115
E080065	C69(3)	GM647P	A53(2)	150087	B112	5222	C153	5431349	C80
E080066	C69(2)	GM81A	B39(2)	150151	B112	5382	B218	5438457	C105
R11590	BB158(2)	PTO11A	B85	222279	C115	5445	C112	5438498	C136
R12150	B157(3)	PTO12A	B75(2)	450183	B66	5519	B185	146601297	C90
R12760	BB144	PTO14A	B97	1550111	B148	5995	B117	C104X230050	B154
R22800	C162	BLACKWELDERS		1550119	B144	6259	B106(2)	C105500049	C155
R28950	B112	V4034	B31	1550135	B56	6260	B112	C105551068	C175
R28960	B57	V4042	B39	2750005	C1319(2)	6261	B73	C105610197	C118
R50900	BB118	V4049	B46	3950006	C136	6943	A90	C105623252	C150
R51790	C173	V4054	B51	5550010	C152(2)	7896	C115	C105630169	D154
R55730	B128	V4058	B55	5650014	C146(2)	7998	C92	C105758719	B61
R56590	B100(2)	V4066	B63	6050050	BB107	7999	B59	C105767057	B49
R64760	B92	V4069	B66	6050051	B142	8000	B72	C105801222	B117
R65102	BB136	V4108	B105	6050052	B108	8351	C113(2)	C1076515626	B157
R66232	B72	V4115	B112	6050208	CC157	10278	C133(2)	C1273366671	B62
ATLAS METAL		V4123	B120	6050209	CC72	10283	C76(2)	C1273368461	B66
HB75	B75	V4131	B128	6050210	BB158	10287	B170	C5222	C158
AUBORN CON		V4136	B134(2)	6050227	C137	10596	B75	C7896	C115
11108	A96	V4139	B136	9044102	A38	10601	B74(2)	J1787	B57
11109	A80	V4151	B148	50002705	C85	10936	B105	J2819	C128
121707	B100	V4176	B173	50009469	C83	11554	B40	J2980	B75
121716	B108	V4241	B240	50009471	C131	11903	A33	C F E	
147486	B173	V5060	C57	50013184	CC155	11904	MXV4-910	9810940	B136
AUBURN INDUSTRIES		V5068	C65	500010774	CC178	11905	MXV4-510	9811180	C133
11049	A112	V5094	C90	33-053-023	C147	12026	B136	E.L. CALDWELL	
11055	A81	V5103	C100	33-053-025	C109	12448	B52	30423	C81
121616	B120	V5109	C105	33-053-049	2926V856	12478	B107(2)	30462	C71
112617A	B103	V5113	C109	33-053-050	CC105	12540	B56	30472	C82
AUTOMATIC		V5116	C112	S2952	3VX250	13372	C72	30474	C63
AE2510006	B59	BLAIR MAN.		S2954	3V250	14038	C81	30492	C78
AE2510019	B70	C79	C79(2)	BUTLER MFG.		14732	B72(2)	30496	C86
AE2510030	B54	558567	BB112	PC564	A80	14779	B72(2)	34936	C65
AE2510057	B36	BRADY		PC565	A82	14995	B51	36267	A29
AE2510110	B71	12207	B38	PF119	A64	16074	B106(2)	36268	C85
AE2510110	BB116	12208	B58	PF48	A51	16259	B139	A31	A31
B M B MFG.		25012	C79(2)	PJ5068	A26	18419	3L500	A42	A42
4793	B96	25018	C78(2)	PU1061	B35	18916	B139	E15	B108
4802	B112	25067	A49(2)	PU1062	B53	19552	B139	E1581	B81
4803	B120	25084	B51	PU1067	B55	19607	MXV4-390	E15S136	B136
4804	B144	25097	A56	PU1069	B50	19608	C81	CALKINS	
		50145	B49(4)	PU951	B68	19609	B128	32	C164
		50370	B90(8)	PU960	A298	19612	C121	254	C58
						19613	B61	684	C66
						19614	C156	5049001	D105
						19674	C270	15C106	C102
						19916	B120		



WARNING: These products can expose you to chemicals including carbon black which is known in the state of California to cause cancer, birth defects or other reproductive harm. For more information visit www.P65WARNINGS.ca.gov

AG EQUIPMENT & PUMP BELTING PART NUMBERS

NOTE: FHP Belt may be upgraded to the MXV Belt, however the FHP Belt SHOULD NOT be substituted for the MXV Belt

Alphabetical sequence by manufacturer

OEM #	Belt No.	OEM #	Belt No.	OEM #	Belt No.	OEM #	Belt No.	OEM #	Belt No.
CANADIAN CO-OP		55467	B218	151064C1	C63	18143KA	B143	22364K	B55
		56325	C75	151286C1	C243	181718C1	B100	225532R2	3V425
2818	C57(4)	132298	B68	151531R2	3V450	18202K	B43	2287BF	B112
2981	B71	475006	3VX355(2)	15166K	B120	18203K	B135	23221K	B95
14038	C72	4750320	B144	151731C1	C122	182619C1	C149	2324CS1	C158
16074	B51	12614440	C120	152359C1	C144	182945C1	C147	2325CS	C136
4230054	C66	22220301	B71	152585C1	CC243	18413KA	B144	236161R2	3V475
5410283	C77(2)	31261440	C120	152586C1	CC246	184796C1	C108	23898K	B59
5610283	C77	60852020	B62	153301C1	C112	185712C1	C133	24510K	B68
146601297	C90	69153050	B120	153302C1	C89	187415C2	C106	247428A1	C103
1892 (892)	B42	700704407	B49	153359C1	B184	188213C1	C124	24824K	C69
1893 (893)	B51(4)	700705430	B148	154065C1	B286	188716C1	C111	250678R2	CX68
C101J673	C75	0114B	D90	155790C1	C103	188834K	B144	250678R31	CX68(2)
J2819	C128	0115B	A60	156062C1	D110	19003K	C105	25079K	B65
CARDINAL		0147B1	B64	156444C1	B125	191288C2	C93	255FG	B60
		0152BL	B70	156445C1	C103	191290C1	C130	2566HT	C81
5962	A80	04125B	B195	157191R2	B37	191291C1	C139	2567HT	C51
10027	A94	106465C1	MXV4-510	158797C1	C99	191305C1	C108	2569HT	C60
15295	A28	106990C1	MXV4-450	159426C1	A36	191920C1	C130	2572HT	D120
15296	A31	106991C1	A53	159588C1	C101	192288C2	C92	2578FH	B57
15410	B41	107671C1	AX20	160173C1	C93	192360C1	C253	26267K	C116
15411	B240	1090CK1	C96	160870C1	C197	19298K	C75	2704BF	C111
16093	A66	10971FA	B42	160871C1	C128	195060C1	C131	27131K	B109
16095	A120	11464K	B86	160X3HC1	C90	195143C1	C131	27145K	B46
16096	A180	11466R	B53	161122C1	CC195	195493C1	B154	27550K	B98
16114	A112	117465C1	A77	16131DA	C42	196370C1	B210	280210C1,C2	SPA1375
16284	B47	119489X1	C112	161820C1	D197	196371C1	B220	281511R1	CX68
16285	B74	1251214C1	B144	161821C1	D208	1970115C1	C96	284874C1	C140
17571	B300	1253324C1	C86	163544C1	BB120	197411C1	C128	28588K	B52
20306	B40	1304060C2	D173	16397KA	B73	197412C1	C129(2)	28590K	B83
20309	B45	130725R1	AX68	164099C2	B46	197414C1-C2	C143(2)	3021CS	B51
20310	B46	13091CA	B54	1640CS	B65	197416C1	C143(3)	304071R11	C69(2)
20367	B48	1309332X1	B60	165053C2	E112	197418C1	C128	304436R1	AX49
20368	MXV4-290	131303C91	A56(2)	1656676C1	C150	197480C1	C154	3060464R1	B31
20373	B39	131307C91	A58	16649K	A90	197482C1	C154	30982DB	C54
20380	B64	1315169C1	C144	16650K	A76	1989216C1	C132	3113329R1	A60
21485	B63	1315226C1	C84	16651K	BB103	200127C1	C119	3119750R1	3V315
21561	B35	1315315C1	C68	16659K	C61	2002005C1	C100	311CS	C94
A18487	B39(2)	1316573C2	C95	167031C2	A49	200380C1	C93	312515R1	AX51
A18655	B37(2)	1316574C1	C99	168628C1	C130	200380C2	C95	3155177R1	C106
A19487	B136(2)	1319245C1	C104	168678C1	C131	200381C2	C98	3155178R1	C153
A19849	B68(2)	132013C	A28	168725C1	A83	200384C1	C104	3157600R1	CC128
A20042	B45(2)	1321564C1	C59	169708C1	D129	200385C1	C103	3157738R1	D159
A20246	B46(2)	1321565C1	C74	169827C1	C94	200386C1	C96	3157994R1	C130
A20247	B48(2)	132374C1	B138	170145C1	C160	200387C1	C99	31599827R1	SPA950
A20311	B47(2)	13394L	A62	170481R2	A44	2003881C2	C98	316250R1	AX47
A20369	B50(2)	135168C1	C162	171263C1	C143	201644C1	B111	3167361R1	C101
A20371	B51(2)	135462C1	B90	171345C1	D164	20209K	B50	3167489R1	C82
A20805	3V1400	135469C1	B85	171346C1	D141	202486C1	C102	3167797R1	C157
A20806	A35(2)	135563C1	B151	171776C1	D133	202487C1	C110	3168669R1	B83
A20971	B43(2)	135594C1	B196	171994C1	B205	203170C1	B167	3170159R1	B49
A21482	B60(2)	13987K	B81	172230C1	D170	203612C1	C115	3170210R1	C120
CARDINAL		13988K	B112	172323C1	D137	203651C1	B50	3173164R1	D147
		140024C1	A81	172360C1	A82	203658C1	C77	3173717R1	C140
A21484	B63(2)	1407035R1	B141	172369C1	C220	20365K	B75	3175432R1	C130
A21558	B41(2)	1407324R1	C111	172373C1	C70	203708C1	CC85	317904A1	C124
A21562	B35(2)	1408761R1	B148	174614C2	C250	203819C1	C93	3179489R1	C82
A21973	B75(2)	1408840R1	CC122	174637C1	C304	20399K	B103	3211CS	C94
A22563	3V500	1408855R1	C108	174642C1	C283	204214C1	B168	323987R1	AX45
A22701	B52(2)	1410279R1	C116	174967C1	A72	208885C1	CC120	326758R11	B71(2)
A22738	B44	1416764R1	C115	175545C1	B156	209002C1	B137	328539R1	C57
A23141	B64(2)	143441R2	A40	175597C1	C253	209038C1	A62	328540R1	C54
A24926	3V450(3)	143875C1	C90	175739R1	B35	210628C1	B81	338626A1	C140
A25893	BX68(3)	143876C1	C69	176106H1	A40	2117700C1	C107	340347R1	460L10
A25933	B82(2)	144409C1	B89	176565C1	C171	214878R	3V355	351321R1	A19
A26637	B56(2)	14635K	B97	176566C1	C171(2)	2175CK	B48	352095C1	A49
A26944	B56(3)	150433C1	CC202	176567C1	C171(3)	217698C1	C95	358213R1	A20
CARTER		150434C1	CC162	176576C1	C192	217699C1	B106	3601BF	B83
		150435C1	C201	176577C1	C192(2)	217701C1	B88	362828R1	A31
2222	C180	150436C1	D173	177178C1	B79	217702C1	C121	363599R2	CX52
3333	C195	150552C1	B100	177499C1	C274	2178CK	C146	363977R1	3L290
CASE - I H		150628C1	A97	177566C1	C171(2)	2180CK	C85	365686R1	A36
		150629C1	A106	178019C1	C98	2213BD	B136	367697R1	3V425
1010	C90	150670C1	B154	179007C1	B68	2215BD	B76	376230R1	3V315
49575	C65	150814C1	C138	179317C1	B160	22198K	B75	376370R1	A28
55152	B83	150816C1	D163	179325C1	C50	222203C1	B71	378113R2	AX46
55224	B133	150960C1	A112	179763C1	B66	222203X1	B62	3783N	B175
55297	C153	151063C1	C240	181433C1	C157	222886X1	C85	379629R1	AX26



WARNING: These products can expose you to chemicals including carbon black which is known in the state of California to cause cancer, birth defects or other reproductive harm. For more information visit www.P65WARNINGS.ca.gov

AG EQUIPMENT & PUMP BELTING PART NUMBERS

NOTE: FHP Belt may be upgraded to the MXV Belt, however the FHP Belt SHOULD NOT be substituted for the MXV Belt

Alphabetical sequence by manufacturer

OEM #	Belt No.	OEM #	Belt No.	OEM #	Belt No.	OEM #	Belt No.	OEM #	Belt No.
CASE - I H		477180R1	B136	555045R1	BB170	59004C1	A38	61383C1	3L290
		477599R2	MXV4-770	555062R1	B45	591878R1	C135	61384C1	3L240
382228R2	AX49	478259R91	B90	555063R1	B38	591881R1	C80	614419R1	2530V690
38331K	A74	478260R91	B124(4)	555118R1	B183	591891R1	C79	614419R1	2530V700
38332K	A106	478261R91	B51(2)	555142R1	B103	592030R1	A37	614520R1	C272
385674R1	AX47	478262R91	B46(2)	555350R2	BB161	592038R2	B90	614663R1	D165
385738R1	AX47	478263R91	B54(2)	555648R1	C57	592128R1	B75	614777R1,R2	C103
386160R1	MXV3-300	478881R3	A79	556006R2	C126	592164R1	B73	617910R1	B75
38701K	B150	478942R1	C75	556107R1	B105	593317R1	C69	617911R1	A40
3904460R1-	CX64(2)	4801BF	B85	556560R4	B109	593646R1	D133	618018R1	B162
394013R1	AX51	48024DB	CX45	557572R1	B258	593781R1	B72	618628R1	B146
395539R1	A61	48070K	B195	558141R1	C101	593783R1	B56	618827R1	B124
396829R1	AX42	481099R2	MXV4-830	558486R1	C130	593802R1	B140	618829R1	B167
396830R1	AX49	482223R2	C55	558564R1	BB144	593835R1	2530V1290	619248R1	B165
39715R1	AX45	483502R1	B63	559028R1	C104	593836R1	2530V1490	62234C1	3V530
401128R2	AX56	483878R1	C46	559063R1	C75	593892R1	B140	62235C1	3V530
401191R1	A66(2)	485764R1	C47	559064R1	C146	594355R1	B165	62379C1	A34
4013CH	B97	486543R2	C58	559899R1	B128	595185R21	C62	62397C1	A50
401691R1	AX32	487043R1	3V280	560310R1	D101	595348R11	C101(2)	626589R1	CC183
401960R1	MXV3-310	487046R1	B112	560431R1	C156	59560C1	A36	626789R1	D161
402253R91	A66(2)	487455R2	A43	560457R2	B101	595621R1	D97	627297R1	B39
402254R91	A64	487456R1	A49	560689R1	C84	595756R1	C150	62817C1	A47
40348R1	AX44	487939R1	C57	560920R1	C152	595921R1	D80	628308R1	D170
403617R1	AX45	487994R1	A35	560923R1	B90	596174R11	C100	629297R1	B39
4037B	C118	487996R1	A33	561093R1	B110	59620C1	A53	629323R1	C57
4038B	C90	488077R1	MXV4-480	561133R2	BB130	596222R1	C138	629334R1	CC162
4049CS	C82	1408855R1	C108	562088R1	C99	59636C1	A28	632702R1	C108
406097R1	AX54	488082R2	A50	56235C1	A66	596595R1	C63	633723R1	D139
4105BF	B78	48878D	A29	562643R1, R2	C128	59701C1	MXV4-770	633724R2	C132
422CS	B95	4891BF	B85	562655R1	C149	59702C1	MXV4-850	633726R1	C140
4241CH	B89	489397R3	3V750	563782R1	B130	597695R2	B95	633727R1	C167
42705C91	A48	489399R1	MXV4-800	564494R2	C110	597736R1	B77	633728R1	D165
4350B	B49	490489R1	SPA2032	564728R1	C172	598141R1	C101	633728R1	D167
4351B	B52	492103R1	B100	564733R1	C164	598622R1	B215	634891R1	CC196
4352B	C133	49291D	A24	565565R1	B168	598676R1	C128	637702R1	C108
4369B	B162	49341D	A32	565879R1	D88	599148R11	C124	640410R1	B87
4402CS	C165	493649R1	MXV4-730	565917R1	B83	599355R1	C124	640491C91	BX60(3)
4429CS	B137	493650R1	A47	56629C1	3V355	599428R1	C103	640521R1	B71
452197R1	B43	495756R1	C66	567252R1	C133	599690R1	AX61	65337C2	A35
452460R1	C75	49A	C48(2)	567273R1	C66	59971C1	3V780	656349R1	B48
452864R1	C60	515443R1	B42	567947R1	C51	606665R1	B173	657185R1	C75
455025R21	C83(3)	51BL	B70	568230R1	CC158	606685R1	B173	657411R1	B87
455992R1	B44	52318DA	A26	568583R1	C130	606719R1	B125	657911R1	C101
456755R1	C108	527470R1	A58	568732R1	D107	607344R1	C109	657911R1	C101
457191R2	B38	527621R1	3V475	568773R1	C75	607355R1	C80	658052R1	B51
457292R1	B42	530076R1	A61	568938R1	D110	607421R1	C104	659200R1	B47
457469R1	C63	530186R1	AX62	568952R1	C136	607446R1	C86	659224R1	B51
457934R1	880L16	532031R2	3V530	569158R1	C131	607658R1	C144	659904R11	B128
4619BF	B72	534310R1	AX61	569194R1	D173	607666R1	B81	65999R1	BX61
4619BF1	B73	534311R1	AX59	569663R1	C164	607898R1	C86	660000R1	C106
462133R1	C86	534861R1	AX28	569692R1	C86	608890R1	B171	66068R1	D112
464351R1	MXV4-300	540509R1	C87	569845R1	D130	608892R1	B71	662213R1	C54
464362R1	A80	540609R1	C87	57034C1	C76(3)	609720R1	C143	662896R1	B111
467412R1	C162	542177R1	B124	570386R1	B177	610389R1	BB68	662897R1	B43
469095R1	C90	543394R2	D94	571434R1	D137	610402R1	B195	662899R2	C75
469615R1	B60	544624R1	2L355	574615R1	A51	610406R1	C72	662900R1	B105
472669R1	C98	545540R1	C72	576835R1	AX50	610410R1	B87	662901R1	B55
473462R4	A79	548026R1	C81	57842C1	A32	610411R1	B90	663006R1,R2	C69
473468R2	MXV4-720	54857DB	A275	579897R1	B151	610428R1	D160	663480R1	C69
473528R1	C92	549107R1	A37	579941R1	B62	610462R1	A34	665030R11	C99
474054R1	B162	549108R1	MXV4-380	579964R1	B60	610520R1	B68	665299R1	B91
474081R1	B144	549609R1	MXV4-500	580026R1	B127	610521C1	B71	665398R1	D105
474099R1	B67	549714R1	3V375	581832R1	B88	610521R91	B71	665399R1	D98
474512R1	C162	549821R1	A29	582308R1	B186	610531R1	B152	665970R1	D88
474522R1	C173	549822R1	MXV4-680	582450R1	B125	610534R1	B85	666390R1	C109
474568R1	B158	550950R1	C114	582557R1	D162	61083C1	MXV4-320	666452R1	D120
474569R1	C128	551911R1	B116	583648R2	D93	61084C1	MXV4-590	666453R1	D114
474768R1	B38	552244R1	B101	58532C1	B79	610986R1	B83	667068R1	D112
474768R1	B38	552244R1	B101	585457C1	D85	611093R1	B105	667114R1	D107
474768R1	B38	552747R2	C96	58663C1	A69	611232R1	C105	668057R1	D111
475595R1	A24	553079R1	B114	58764C1	A34	611608R1	B271	668287R1	C78
475694R1	A45	553139R1	B95	58765C1	A28	611930R1	B62	668287R2	C83
475725R1	3VX800	553406R1	B75	588894R1	B57	611932R2	C75	668288R1	C72
475739R1	B35	553456R2	B48	589145R1	D108	612046R1	B190	668307R2	C81
475834R1	A52	553603R1	B105	589622R1	B215	612460R1	B109	668477R1	D99
475972R1	B55	554454R1,2	B90	589623R1	B206	612487R1	A46	668496R1	D109
476198R91	3VX800(2)	554485R1	BB155	589643R1	B49	61284D	A30	668902R1	B77
477179R1	B120	554653R2	B137	59003C1	A42	613449R1	A45	668929R1	B62



WARNING: These products can expose you to chemicals including carbon black which is known in the state of California to cause cancer, birth defects or other reproductive harm. For more information visit www.P65WARNINGS.ca.gov

AG EQUIPMENT & PUMP BELTING PART NUMBERS

NOTE: FHP Belt may be upgraded to the MXV Belt, however the FHP Belt SHOULD NOT be substituted for the MXV Belt

Alphabetical sequence by manufacturer

OEM #	Belt No.	OEM #	Belt No.	OEM #	Belt No.	OEM #	Belt No.	OEM #	Belt No.
CASE - I H		866725R2	B81	F6450	C148	1K583	C128(3)	6L6551	B84(3)
669105R1	B158	8704HT1	B192	F6452	C190	1K612	C136(4)	6L8358	5VX1000
669257R1	C60	8705HT1	B195	F6734	C158	1K621	C173(7)	6L8359	5VX1000
669456R1	C81	874097C1	SPA1000	F6833	B180	1K7937	C128(3)	6L9492	CX51
670143R1	D118	882668C1	A60	F7865	C207	1K7938	C173(7)	6N4544	CX81
670144R1	D112	8K15666	B236	F8047	B51	1K7939	C173(6)	6N4545	CX81
670278R1	D97	935016R2	A65	F8398	C195	1K9528	C173	6N4548	BX71
670282R1	D107	935573R1	A78	F8469	C88	1K9531	C128	6N4549	BX78
670761R1	B84	935721R1	B105	F8492	B230	1K9553	C128	6N4550	BX78
671465R3	A46	936156R1	C228	F8549	C83	1N9382	5VX850(5)	6N5337	BX77(3)
671894R1	B70	936190R2	C77	F8819	C212	1N9383	5VX850	6N5760	B89
672177R1	C77	936191R1	C188	F9072	C185	1P202	BX61(2)	6N5761	B89(5)
672178R1	C80	936321R1	A56	F9442	C210	1P7837	BX70	6N6550	BX71
672184R1	C86	936620R11	B68(2)	F9468	C88	1S1127	BX55(2)	6N6651	BX71(3)
672627R1	C93	937806R1	B161	F9587	C173	1S1207	B87(2)	6N6653	BX60(4)
672974R2	D85	937928R1	CC157	F9640	A69	1W0422	BX75(4)	6N6654	BX67
673685R1	C94	937931R1	D173	F9659	C158	2L291	CX68	6N6655	BX67(3)
673970R1	B110	937932R1	D109	F9679	B210	2N8612	BX51	6N6656	BX60(3)
674620R1	C91	950477R1	B120	F9868	D147	2P1137	BX83(2)	6N6657	BX60
674965R1	C101	950478R1	B53	F9935	D147	2P1138	BX83(2)	6N7053	BX75(3)
675905R1	C101	9704HT	B81	FH055079	B68	2P1272	CX60	7+W5229	BX96(6)
676622R1	3V375	9894HT	B81	FH055293	B144	2P1300	CX60	7A1730	C173(7)
676626R1	3V315	A30249	C50(2)	FH055343	B158	2P1388	CX60(2)	7A7882	5VX950(6)
676644R1	AX29	C18360	A130	FH055442	B195	2P2356	BX71	7B9545	B65
676645R1	3V425	C18910	A66	FH055574	C96	2P2357	BX71(2)	7C2500	BX77(3)
726278R1	B53	F11139	C77	FH055616	C144	2R7443	BX51	7F6639	B84
726278R1	B45	F12180	B173	FH056085	B146	2S4792	BX79(3)	7L7882	5VX950(6)
726285R1	B55	F12280	D144	FH056119	B173	2S5279	BX79	7L9468	B72
73691C1	3L345	F12765	C188	FH056390	BB158	2S8268	BX78(3)	7L9469	B72
73692C1	A32	F13511	C214	FH056812	CC158(2)	2S9911	BX78	7M4691	BX52(2)
73808C1	3L310	F13540	C190	FH057307	B170	3B7142	CX75	7M4710	CX81(2)
73810C1	3L360	F13541	C220	FH057513	CC154	3H9859	C97	7M4719	CX68
754CS	B125	F13800	D147	G3308	C128	3K3433	BX54(2)	7M4720	C97
769482R1	SPA982	F14771	B41	I32298	B68	3K8821	BX54(2)	7M4721	CX75
7895HT	B143	F14847	D164	K5050S	B124	3L7011	C78	7M7373	BX79
790522R1	C75	F14857	D164	K8404S	B131	3L9489	C78	7N3117	BX100
793037R2	CC127	F16447	B120	KB16353P	CC144	3R2120	BX90	7N3118	BX99(5)
793094R2	C63	F16710	B210	M32812	C48	3R3660	BX65	7N3120	BX103(5)
793398R2	C113	F16744	C79	M32813	C50	3R3661	BX65	7N3121	BX95
793417R1	C148	F16867	C125	M81094	C83	3R5603	5VX710	7N3122	BX95(5)
794484R1	C105	F16932	D128	MA42292	C57	3R5604	5VX710	7N4148	BX82(4)
80130C1	A62	F17082	B114	N1677	C85	3R9089	5VX750(4)	7S8349	B73
822738R1	A38	F17235	C136	N3342	C80	3R9090	5VX750(4)	7S8350	B73(2)
822811R1	C68	F17445	C96	N3400	C63	3R9346	BX67(2)	7S9809	BX77
823091C1	B280	F18303	B255	N4648	B40	3S9646	BX79(3)	7S9810	BX67(2)
824202C1	B144	F18661	B34	N5403	B192	3S9647	BX79	7W3222	B70(4)
824274C1	C140	F18677	B43	O1144B	D94	3V400	3VX400	7W8135	BX80(6)
824680C1	B150	F18971	C116	S0792C	C75	4N1745	BX79(3)	7W8137	BX78(6)
824810C1	B293	F19026	B51	S09098	B79	4N2531	BX59	8B3546	CX75
824810C1	B296	F19027	B116	S1002C	B98	4N2532	BX59(2)	8B5792	BX68
824880C1	B150	F19094	B152	S1154CC	CC112	4N2898	BX80	8B9947	BX81
824881C1	C156	F19157	B180	S1229	B120	4N4978	BX71	8L5136	BX52
825298C1	C116(2)	F19498	C96	S1242C	C120	4N6302	B73(3)	8L5137	BX52(3)
825881C1	C155	F19549	C149	S1402C	C136	4N8197	BX81	8M3646	BX54(2)
825941C1	B218	F19550	B158	S1469B	B144	4N8198	BX81(3)	8M391	CX68(2)
825942C1	B256	F19578	B150	S1609B	B158	4N8216	BX53	8M934	CX75
825943C1	B214	F19581	B51	S1609BB	BB158	4N8217	BX53(2)	8M959	CX75
826724R1	D120	F19939	C173	S1759B	B173	4N8219	B72	9B3214	B73
826726R1	B115	F20033	C136	S1829B	B180	4N8220	BX56	9H9990	B84
826730R1	A38	F20061	D128	T11742	C349	4N8277	BX70	9L4265	A76
826731R1	B101	F20135	B41	T16405	C390	4W5767	C71(2)	9L6725	B70(2)
826733R1	B60	F20628	C122	T30276	B57	4W8510	BX77(4)	9N1321	B57
826734R1	C144	F20712	D112	T32298	B68(2)	5H7371	CX81	9N1325	BX58(3)
826737R1	A44	F20721	C75	T37892	C78(2)	5L5016	C78(2)	9N1326	B57(3)
826740R1	C152	F20722	B97	T39995	A38(2)	5L5185	5VX560		
829356C1	B79	F22013	B40	V35052	3VX375(2)	5L7423	5VX800	CENTRAL TEXAS IRRIGATION	
829413C1	C112	F22398	C108	Y24766	B71	5L7426	5V950		
829626C1	A40	F22765	B58	Y24824	C69	5L7704	5VX630	CTIW2010256	B44
829920C1	A52	F22821	C140	CATERPILLAR		5R1185	BX79	CTIW2010257	B66
829921C1	A44	F22945	A41	287441	B61	5S1762	BX83	CTIW2010258	A71
830122C1	3V355	F37748	5VX800	387142	CX75	5S290	BX77	CTIW2010322	A78
830123C1	3V400	F41177	D120	619495	B49	5S9078	BX65(2)	CLAAS	
832017C1	C130	F51534	B105	742026	B112	5S9078	BX65		
832044C2	C152	F53212	B89	758719	B122	6B9737	C97	523931	A59
833726R2	C140	F59456	B122	854653	BX75	6L1977	CX75	56961	A54
866725R1	B83	F59538	B131	1K2361	C173(6)	6L1987	C78(2)	60064	D297
		F6342	C61			6L3510	5VX560	60306	SPC3550

WARNING: These products can expose you to chemicals including carbon black which is known in the state of California to cause cancer, birth defects or other reproductive harm. For more information visit www.P65WARNINGS.ca.gov

AG EQUIPMENT & PUMP BELTING PART NUMBERS

NOTE: FHP Belt may be upgraded to the MXV Belt, however the FHP Belt SHOULD NOT be substituted for the MXV Belt

Alphabetical sequence by manufacturer

OEM #	Belt No.	OEM #	Belt No.	OEM #	Belt No.	OEM #	Belt No.	OEM #	Belt No.
CLAAS		644267	B67	7834301	B64	903451	B48	117623	B54
603062	SPC3550	644447	B214	783476	SPA2432	9033800	3VX265	117626	B136
603603	SPC3550	644448	A77	783876	A97	19033650	A63	117627	B112
60949	SPC7450	644771	C156	785176	B162	19033820	3VX300	117631	C144
61214	C317	653059	D152	800309	B88	3471M	B68	117635	B157(2)
61252	C339	653062	D159	801222	B118	CLEVELAND FARM		117666	A68
61253	C336	653064	D169	802931	B124	100102	B120	117680	A26
613062	SPC3550	653450	SPB2000	8217342	A107	400101	B50	857706	A59
613531	C325	653933	B60	857243	C295	400123	B132	DAVID MFG.	
61360	C324	654013	C150	947916	B40	970060845	B136	1025	A90(2)
617011	C184	656028	B54	14438075	C75(2)	COLT MAN.		1027	A55
61872	C174	659025	A33	133528(0)	XPA1357	A70226	B59	DMC0488	A48
61878	C213	661244	A61	64401401	C70	A70227	A66	PT0491	B52
61902	C248	661245	A64	CLAEYS		A70296	B61	PT0492	B52
62043	C239	661345	SPA2932	230042	B38	A70304	A80	PT0500	A60
703101	B154	6613781	C251	230043	B55	A70525	B58	PT0502	A66
77276	A151	6611425	B136	230050	B155	C10509	A30	PT0512	A90
77400	B85	667242	B56	230053	C60	COLTEC INDUSTRIES		PT0514	BB120
133549	AX52	667454	C258(2)	230054	C66	128085235	3VX355(2)	PT0515	A96(2)
1335491	AX52	667456	XPA1270	230060	C117	128085237	3VX375(2)	PT0531	BX51
133641	XPA1715	667477	B161	230064	C188	128085242	3VX425(2)	PT0532	B50
145262	BX50	667551	C304	230073	C128	128085245	3VX450(2)	TO488	A48
145265	XPZ1250	6675611	A112	230074	C144	128085342	3VX425(3)	DESERT IRRIGATION	
2338431	B64	667673	XPA1215	L3070	C118	128085345	3VX450(3)	77196	AA96
3440141	C70	667683	C148	M733515	B55	128085360	3VX600(3)	DEWEZE	
501925	B110	667684	C86	MZ3506	C90	128085453	3VX530(4)	940002	A128
503939	B66	6677982	B101	MZ3511	C120	128085460	3VX600(4)	940012	3R/3VX500
503969	D132	667957	B107	MZ3514	B38	128085550	3VX500(5)	940020	3R/3VX315
505051	D157	667973	B120	MZ35160	A51	128085553	3VX530(5)	942005	3VX450
507020	B140	667974	B198	MZ351622	3L420	128085556	3VX560(5)	942014	A120
509435	C179	671013	C117	MZ354005	C144	128770356	5VX500(3)	942096	3R/3VX300
512087	XPA1570	672353	C200	MZ354007	CC195	128770375	5VX750(3)	DISTRIVELEZ	
532011	B52	672358	C111	MZ354009	C126	128770575	5VX750(5)	32X4394	D167
560662	C144	673639	D156	MZ354195	B158	CONTINENTAL BELTON		DRESSER INDUSTRIES	
573443	C93	673690	C67	MZ33515	B55	KA251C162	C162	11338	C51
602387	XPA1515	685693	SPA1307	CLARK EQUIPMENT		KA252C173	C173	14589	B42
6023871	XPA1515	687046	B108	6515271	2926V606	KA253C180	C180	14605	B120
603017	C224	689175	B50	6519206	B51	CONTREE		18283	B55
6030173	C224	703314	B93	6558363	B53	BAC-28-10	400J10	1278510	A60
603283	C112	706087	B143	CLAY EQUIPMENT		BAC-28-10-150	320J10	017-1321-3	A41(2)
603290	C159	706829	D115	3328	A26	BAC-28-10-150	440J10	017-1390-8	A26
603337	C111	713506	B103	3330	A28	BAC-28-8	320J8	474569R1	C128
603341	B60	720695	SPC3750	3334	A32	CROSS EQUIPMENT		478261R91	B51(2)
603378	B47	721295	B57	3337	A35	HB155	B154	545540R1	C72
609441	C205	721306	SPZ1812	3338	A36	CUSTOM FARM		DURA CORP.	
617001	D98	721307	SPZ1837	3342	B39	5523	A75(3)	61106	C128
617309	D128	722107	SPZ1900	3437	B34	5526	A75(3)	242029	C110
618123	B87	724141	C132	3438	B35	96531	B150	20028093	B112
621903	SPA932	724168	C97	3439	B36	99050	B158	20028103	B98
6219031	SPA932	724247	C245	3440	B37	D K MFG.		20031197	C81
623427	B197	724248	C245	3441	B38(2)	661565	B75	EDWARDS EQUIPMENT	
6234271	B197	724301	C107	3442	B39	661566	B112	11641	B38
624131	B39	733311	C97	3443	B40(2)	901559	B97	11685	B128
629002	B51	742025	C107	3444	B41(2)	901563	B136	DC305	B112(2)
6290021	B51	742026	B112	3445	B42	901565	B90	ELLIOT MFG.	
6290811	C157	746505	SPZ1700	3448	B45	901566	B133	FSM2425	C101
6292141	B62	746506	B116	3449	B46	901568	B130	ENID FOUNDRY	
629402	B191	746550	SPZ1700	3452	B49(2)	902160	B92	4727	5VX1000(2)
629410	C63	7501932	B55	3453	B50	4873	5VX1250(2)	BD44	C56
629441	C201	750288	B120	3454	B51(2)	DANUSER		BSP16	B61
629732	B210	750294	B72	3455	B54(2)	EVERSMAN		155013	B61
6297321	B210	750296	B41	3456	B58	11764	B124(2)	535077	C173
629764	A36	750624	B41	3457	B59	11766	B46(2)	535313	A75
629836	C153	750888	B120	3458	B63	DAFFIN		ENID FOUNDRY	
629908	XPA1060	755070	B60	3459	B65	4727	5VX1000(2)	BD44	C56
6299081	XPA1060	756051	C85	3460	B66	4873	5VX1250(2)	BSP16	B61
630118	D143	758662	B65	3461	B77	DANUSER		EVERSMAN	
630144	D163	758719	B61	3462	B112(2)	11764	B124(2)	155013	B61
630149	D162	758854	SPB22120(2)	3466	B59	11765	B51(2)	535077	C173
630169	D156	760419	C81	3468	B63	11766	B46(2)	535313	A75
633030	B53	767057	B49	3469	B65	DAFFIN		ENID FOUNDRY	
6330301	B53	7670571	B49	3470	B66	4727	5VX1000(2)	BD44	C56
6340191	B78	772657	C93	3471	B67	4873	5VX1250(2)	BSP16	B61
635494	B157	773313	B173	3472	B77	DANUSER		EVERSMAN	
6397322	B210	775698	B81	3473	B112(2)	11764	B124(2)	155013	B61
644209	C127	7832681	XPA1307	3474	B116(2)	11765	B51(2)	535077	C173
				903433	B30	11766	B46(2)	535313	A75



WARNING: These products can expose you to chemicals including carbon black which is known in the state of California to cause cancer, birth defects or other reproductive harm. For more information visit www.P65WARNINGS.ca.gov

AG EQUIPMENT & PUMP BELTING PART NUMBERS

NOTE: FHP Belt may be upgraded to the MXV Belt, however the FHP Belt SHOULD NOT be substituted for the MXV Belt

Alphabetical sequence by manufacturer

OEM #	Belt No.	OEM #	Belt No.	OEM #	Belt No.	OEM #	Belt No.	OEM #	Belt No.
EXCEL INDUSTRIES		1A1158	2R/3VX800(5)	32070	B136(4)	117119	B49	166479	B58
017-1415-3	AX112	1A1567	B92	32071	B136(5)	117120	B55	166808	B111
017-1452-6	A28	1A1569	B100	32072	B105(3)	117121	B57	167537	B162
017-1498-9	BX73	1A3091	2R/3VX800	32840	B105	121144	A53	168106	B158
017-1504-4	BX90	1A800122	B144	33552	C49	121764	C57	168141	C153
017-1507-7	BX82	1A80023	B180(2)	34170	B58(2)	121960	C70(2)	168371	B124
020-1007-2	AX46	1A981	3VX800	34270	C100(4)	121961	C70(2)	168524	B173
020-1008-0	AX55	1R1188	3VX800(10)	34271	C100(4)	124090	B71	168618	C105
020-1009-8	AX58	7624-4	3R/3VX750	34647	B100(3)	126570	B105(5)	168772	B68
020-1010-6	AX60	A180022	B144	35214	C72	126805	A33	168773	B68(3)
020-1011-4	AX64	A3031	2R/3VX800(4)	36682	B126(4)	126866	A42	168774	B142
020-1012-2	AX68	A70973	B50(2)	36683	B126(4)	127831	C90	168791	B45
020-1013-0	AX71	A7102-B	B92	37004	C51	127934	C73	168891	B117(6)
020-1014-8	AX75	A71034	2R/3VX800(4)	39184	C61(5)	129149	C164	168892	B117(6)
020-1015-5	AX80	A71035	3V800(12)	39601	C52	129696	C90	168894	B135(6)
020-1016-3	BX66	A71051	5VX600(2)	40624	C60	130224	A36	169122	B59
020-1018-9	BX93	A7105-2	B87(5)	40706	C104	131725	C99	169134	B51
020-1019-7	BX97	A71056	2R/5VX1060(3)	41071	C61(5)	132888	C274	169551	B76
020-1020-5	BX112	S444	B57	42001	B114(5)	132995	C65	169582	C150
020-1021-3	BX136	7765	C55	42002	B113(5)	133028	C83	170203	BB68
020-1022-1	BX120(2)	8916	C131	42609	A38	133099	B45	170395	C102
020-1023-9	BX68	FARRAR MACHINE		42615	B38	133875	B112(2)	170878	B69
020-1024-7	A64	B56	B56	43174	D80	133929	A41	170879	B49
020-1025-4	AX31	C60	C60	43950	B128(2)	134034	B131(5)	171149	B115
020-1026-2	AX33	C68	C68	43951	B128(5)	136233	AX34	171680	B56
020-1027-0	AX35	FIELD QUEEN		45089	B80(5)	137390	A44(4)	171681	B82
020-1028-8	3R/3VX630			46095	C90	137695	C107	171885	B62
020-1029-6	A52(2)	7855117	B55(2)	46914	C85	137945	A49	171886	B61
020-1030-4	3VX600	FINN CORP.		47641	C79(4)	137950	C147	172198	B81
020-1036-1	B32			47642	C79	139366	3L330	172930	B87
020-1038-7	B34	21374	3R/3VX375	47791	B96(5)	139642	B130(5)	174297	C115
020-1039-5	BX63	FLEMING MFG		47808	3L230	139931	A44	174718	A33(2)
020-1042-9	BX51			47844	C160	140022	C51(2)	178486	B112(6)
FARMHAND		94356	B64	48224	B96(5)	140247	B83	179148	B112(4)
4805	5VX1120	94367	C120	48225	B80(5)	140872	B66	179878	C66(2)
15806	B68	FOOD MACHINE		48390	BB112	141063	C78	179944	B115
17380	C173	1032775	17660	49757	C95	141954	B68	179945	B115(6)
17939	B54	1036785	17440	54189	B68	142643	B57	179946	B133(6)
17940	B52	1107398	A46	54713	B120(5)	142889	B50	181068	C108
21173	B83	1107400	A51	54714	B120(5)	142967	B85	181450	A105
21217	C173	1107403	A60	56212	C78(2)	142976	B86	182315	C120(2)
21618	17415	1107407	A68	56213	C78(2)	144795	B116	182381	B96(2)
42722	5VX900	1107407	A68	56321	B112(5)	144796	B141	183406	C83
76047	A39	1108424	B51	56322	B112(2)	144797	B66	184212	B95(2)
76105	BX60(2)	1108425	B53	56929	BB105	144798	B66(3)	184213	B95(5)
76171	B54	1108428	B62	58417	C112	145114	B48	184243	A61(2)
76173	B83	1108434	B75	58418	C112(5)	146141	B53	186347	C100
76174	B90	1108446	B112	63106	C128	146619	C140	195093	B114(4)
76178	B133	1108639	B144	63685	SPB1425	146620	B49	198684	B71
76191	C85	1230340	B55	63804	C98	147094	A56(2)	213105	C65(4)
76192	C112	1278510	A60	64180	3L310	147849	C45	213783	A57
76193	C144	51050780	B140	64218	C78	148083	A51	213819	A72
76194	C158	81220070	A85	64234	C60	159837	B96	213890	A75
76195	C173	181220070	A85	64248	C120(2)	160036	B108	214252	C83
76197	C210	2327181K	A158	64249	C120	160037	B133	214778	3V375
76199	C75	59A1805	17670	64250	C103(2)	160038	B152	215249	C90
76241	3V950(2)	SM124	B124	64251	C60(2)	160039	B162	215619	A34
76581	3VX900/4	SMC51	C51	64685	A49	160041	B81	215620	A57
77251	5VX1060/5	FORD/NEW HOLLAND		65489	B65	160044	B55	216501	C66
77252	5VX850/5	668	B144	66232	C124	162213	B81	217187	B130
760411	A42	1034	C112	66351	B79	162248	B76	217198	B96
760415	A49	1035	CC144	66352	B65	162353	B120	218690	A130
761710	B117	1036	B137	72440	4L190	162547	B136	219133	A41
761712	B158	1037	B165	75440	3L190	163041	B114(6)	219349	3V315
761718	B173	13406	C83	76289	C95	163152	C72	219435	A50
761719	B120	13414	B136	100047	A54(2)	163437	C150	219690	B124
761720	B144	13416	C83	103160	915L16	163640	B111(2)	220377	C53
761721	B180	13820	B136	103350	A55	164437	B50	221458	B133(2)
761722	B76(2)	15092	B79	103724	A55	164556	BB96	221636	C81
761910	C90	16968	B93	103725	A55(2)	164706	B71(2)	224354	A28
761913	C128	17811	B57	105215	A60(2)	164952	C111	224571	A64
761914	C180	17811	B57	105763	B71(4)	165073	B55	225915	C79
761915	C195	21960	C68	106236	B74	165276	B128	226487	B106
1024371	C103(2)	22636	C81	113035	B178	165327	B71(2)	226488	B106(4)
1A1023	B105(2)	25618	C68	113036	B225	165419	C81	227247	C78
1A10372	3V800(12)	25665	A37	113037	B240	165421	B60	228366	A27
		26977	A30	113039	B300	166203	B67	229163	B67(2)
		29431	D110	113040	B349	166345	A46	229543	B144



WARNING: These products can expose you to chemicals including carbon black which is known in the state of California to cause cancer, birth defects or other reproductive harm. For more information visit www.P65WARNINGS.ca.gov

AG EQUIPMENT & PUMP BELTING PART NUMBERS

NOTE: FHP Belt may be upgraded to the MXV Belt, however the FHP Belt SHOULD NOT be substituted for the MXV Belt

Alphabetical sequence by manufacturer

OEM #	Belt No.	OEM #	Belt No.	OEM #	Belt No.	OEM #	Belt No.	OEM #	Belt No.
FORD/NEW HOLLAND		255603	3V400(2)	422731	C126	642920	5V1600P/4	247428A1	C103
		259325	2R/3VX450P	427455	SPA1732	643339	B128(2)	328826(A)	A76
230037	SPA1082	259347	3V425	427456	B83	643353	B144(2)	FORMALLO	
230038	SPA1060	259348	3V475	431784	SPB2840	643574	B43(3)		
230039	SPA1307	259477	B65	432642	SPA1632	644733	B101(3)	17F188	B63
230041	B38	263765	B99(2)	433639	B60	649035	5V1600/6	FOSTER	
230042	B39	263766	B99(2)	433746	B180	649108	B103(3)		
230043	B55	265402	A54	434046	C110	680345	A88(2)	10850	A85
230044	B70	266319	B80(5)	437033	C77	689933	A46(2)	20660	B66(2)
230045	B75	266322	B80	439495	A138	691507	A77(2)	20710	B71
230046	B93	269973	B97	439496	A99	696719	A33	21200	B120
230048	B115	271471	C259	447041	C87	697484	C120(2)	21640	B166
230049	B153	273037	5V500	448794	C156	699351	C77(2)	30900	C90
230050	B158	274224	SPB2500(4)	449380	SPZ1625	703274	A46(2)	32700	C270
230051	C47	283105	C114	513220	3VX900(2)	703747	C92	33000	C300
230052	C49	283659	B101(3)	516712	3V425	705807	B90(2)	33150	C315
230053	C60	284062	C57	516713	3V375	705808	B90	33300	C330
230054	C65	284063	C90	516776	B128	708178	B102(3)	33450	C345
230056	C77	285236	B97(2)	523946	B140	708712	A52(2)	34200	C420
230057	C89	287499	A103	525351	3V355	709414	B97	B51	B51(2)
230059	C108	302793	C136	529944	B144	709997	B80(2)	B58	B58(2)
230060	C118	309364	C74	570221	C88	709998	B80(2)	B64	B64(2)
230061	C136	320059	C109	571895	A91(3)	710714	B80	B88	B88
230062	C159	320883	BB103	571924	A91(3)	710754	C51	C112	C112
230063	C180	321528	C83	571927	A36(2)	713281	B109	FOX BRADY (KOEHRING)	
230064	C187	321582	C130	571928	A36	716254	BB45		
230065	C220	322686	C143	573957	A54	716258	B62	1019	C78
230066	C255	323037	B162	576712	5VX500(2)	716413	C118	25012	C79(2)
230068	C300	323318	C101	576772	B67(2)	716414	C118(3)	25084	B51
230069	C328	323413	C75	576773	B67(2)	716415	C92	25087	A56(2)
230070	C347	323661	C72	576774	A45(2)	716416	C92(3)	25151	C73(2)
230071	C417	323904	CC164	576776	A52	717075	C113	25168	C81(2)
230073	C128	324632	C105	577900	C73	719923	5V800(2)	51600011	BX58
230074	C144	326298	C63	578073	A70	740323	C187	51600012	AX59(4)
230108	B114	327024	SPZ1287	578206	B167	753053	C131	51600019	C83
230127	SPA1332	327041	SPZ1060	578897	C51	781479	C78	51610015	A57
230128	B205	327062	SPA1180	579363	B80(3)	786310	B105(4)	51610016	A44
230131	SPA1060	328821	MXV4-830	579364	C60(2)	788803	5V1600P/4	51612003	B48(3)
230143	B195	330204	B67	592789	A55	791479	C78	51612005	B58
230151	B51	330715	C140	593325	B162	797978	5V1600P/4	51612020	B64
230154	B124	331019	B200	595717	B40	797979	5V1700/6	51612025	B32
230156	B135	333255	C170	604805	C112(2)	799532	C75	51612026	B68
230164	C96	333347	CC138	605529	B144	835042	C120(3)	51614009	C59
230168	C158	333958	C133	605578	C224	849887	A56(2)	51614010	C66
230180	B112	335258	B55(2)	605580	C255	849888	A56	51616000	D101
230267	C282	336386	SPZ1337	605652	C103(2)	849889	A60(2)	51616002	D92
231230	B188	336426	SPZ1337	605654	C60(2)	849890	A60	51616006	D140
234591	3VX450(2)	336610	C141	605656	C162	852123	C76	51616009	D151(2)
234658	3VX355	337415	C98	605666	C283	852186	C78	700001223	C115
235084	3L280	338921	C154	605988	C120(2)	913151	B77	5M4B2A	B83
238380	B105(2)	350245	B140	610678	A48	914040	C158	5M4B2B	B91
238895	A29(2)	350312	C79	610767	AX64	923019	A119	B4B1	B85
239103	B57(2)	353584	C145	612305	A66	1001274	A63(2)	B4B2	B49
239104	B56(2)	354338	A33	613568	A49(3)	4595717	B40	B4B3	B51
239140	B57(2)	356913	C64	614040	C158	7501214	C53	B4B5	B73
240831	C136	362141	B235	615790	A70	7855729	MXV4-800	B4B5A	B71
240859	B65	362500	B142	618040	B225	9501182	SPA1457	B4B5B	B75
242028	C128	375977	D130	619748	C113	9506748	SPA850	B4B5HM	B73
242029	C110	377164	B190	620944	5V710(2)	9508557	SPA1432	B4B6	B60
242307	B61(3)	378672	CC158	621104	C73	9512971	C65	C4B1A	C124
242464	A97	378989	B67	621367	C116(2)	9513984	C100	F4B4A	D140
242691	B105(3)	381143	B110	621638	C115(2)	9600753	BB95	F4B3	D128
242999	C122	381237	SPA1400	621824	5V1600P/4	9601395	C112	F4B4A	D101
243210	B87	381489	A110	624650	B75(2)	9601699	BX89(3)	SPF4B10	A55
244025	B62	386155	SPZ1147	625449	C73(2)	9609607	B59	SPF4B12	B58
244675	B104(4)	387469	C128	625853	C73	9622032	C106	SPF4B2A	5VX1400
244936	A29	387931	B75	626654	A53(2)	9802891	A63(2)	WB4B1	A54
246727	B186	389245	B73	626655	A57(2)	9804665	A63	FREEMAN & SONS	
246771	A68	393519	SPA1607	627561	B75(2)	9818115	A28	F0007535	CX105
246773	C73	394426	B154	632679	5V800/4	59051790	C173	F7000	D164
246980	D162	395955	C65	632679	5V800/3	86503087	D188	FRICK	
247782	C108	396750	C75	632890	5V800	86514163	5V1730/6		
248133	A38	399058	SPA1767	633512	B101	86514529	B101		
248332	B65(2)	410896	C73	634564	B92	86516668	C52		
248452	B94(2)	421173	SPA1282	635042	C120(3)	86517679	MXV5-900		
253314	3VX250	422441	A106	638337	5V1600/5	86517915	C110	W19054	C124
				640622	B70(2)	137014960	B66	W19055	B162



WARNING: These products can expose you to chemicals including carbon black which is known in the state of California to cause cancer, birth defects or other reproductive harm. For more information visit www.P65WARNINGS.ca.gov

AG EQUIPMENT & PUMP BELTING PART NUMBERS

NOTE: FHP Belt may be upgraded to the MXV Belt, however the FHP Belt SHOULD NOT be substituted for the MXV Belt

Alphabetical sequence by manufacturer

OEM #	Belt No.	OEM #	Belt No.	OEM #	Belt No.	OEM #	Belt No.	OEM #	Belt No.
FRIGGSTAD MFG.		3E1340	A81	D22270	B128(2)	PT311	A120	W79144N	B153
1261002	A46	3E134A	A96	D2261	C240	GRAVES		HART CARTER	
G.T. SALES & MFG.		5.00E+77	B53	D22620	C195	S1037	B180	9810190	D98
XD22620	C195	5E750	B53	D52270	B144	GREEN ISLE		HAYBUSTER	
XD52620	C255	5H75	A54	D52271	B148	HM1058	B55	1600052	BB107
GEHL CO. (OWATONNA)		6H125	B51	D52620	C255	HM1058	B62	HCC CORP.	
5875	A54	6H1250	B51	DRIVE	B195	GRIDER		239169	C120
40047	B53	7H120	B42	GT2066B	B97	1227	MXV4-420	HEATH	
40087	B93(8)	7H1200	B42	GT2067	B225	2427	BB75	80010	C96
40210	B71	9H184A	B100	GT2087	B195	G.H. GRIMM		80011	C144
40875	B72(8)	PH184B	B109	GT4216125	B85	GT167D	D195	80036	B255
42781	B98(6)	9H2420	B42	GT4216164	B158	GT168CC	C147	825003	CC240
47622	B66	9H2422B	B46	GT4216563	B93	GT45	C75	HENKE MACHINE	
47623	B68	9H242A	B49	GT4218123	B90	GROVE MFG.		BB60	BB60
48183	3V670(2)	9H242B	B79	GT42510051	B55	14261	B80	HENRY INDUSTRIES	
52130	A65	9H325	1930V425	GT4256045	B46	HABAN MFG.		H60085	B85
52132	A63	B11241	A26	GT4258045	B48	5191	B52	H60162	C162
52384	A58	B66	C14075	GT4266015GT	B58	11361	MXV4-760	H60180	C180
53673	C66	47622	C14075A	GT5267	B105	12611	B34	HESSTON	
55297	C153	47623	C14105	GT5266	B144	15562	BX112	7780	C255
62127	3VX315	48183	H6060	GT52860	B112	S369	B40	55004	A46
64547	3VX400	52130	H6060A	GT52860	B108	S370	B52	55046	B38
67516	C54	52132	H6060B	GTD52552	B105	S371	B54	55061	B55
67713	3R/3VX425	52384	H6060C	GTD52552	B105	S429	B48	55087	BB68
74622	B66	53673	H6060D	K22620	C180	S449	B46	55103	B69(3)
77972	B59(2)	55297	H6060E	K52701	B75	S450	B78	55111	B71
205467	C112	62127	H6060G	K59321	C55	HABCO		55129	B78
304023	A45	64547	H6060H	GLISSON		DR103	B103	55137	B79
304211	B81	67516	H6060J	NYTROBCA	A62	DR124	DR124	55145	B82
304215	A29	74622	H6060K	NYTROBCT	A60	HAHN INC.		55152	B83
304303	C144	77972	H6060L	NYTROBNI	A38	26863	A40	55160	B87
304304	C162	205467	H6060M	NYTROBNM	A31	27030	A38	55178	B105
600264	3R/3V630	304023	H6060N	NYTROBNS	A35	28440	3VX425	55194	BB112
2010240	C59	304211	H6060O	NYTROBPI	A98	94779	3VX530	55210	B120
2010242	A38	304215	H6060P	NYTROBUA	A42	308280	3VX280	55224	B133
2010243	B126	304303	H6060Q	NYTROBUJ	A48	2C6658	B35	55236	B128
2010244	B140	600264	H6060R	NYTROBUN	A43	2F5582	A75	55244	B133
2010281	B195	2010240	H6060S	NYTRODCA	B62	4C8191	A62	55269	B136
2010503	B93	2010242	H7832	NYTRODCI	B68	HAMACHEK		55293	B144(2)
2010519	B136	2010243	H7850	NYTRODCS	B65	90901	B105	55297	C153
2011400	C78	2010244	H8000A	NYTRODCT	B60	90902	5V1600	55301	BB144
2012079	3V800	2010281	H8000E	NYTRODIM	B81	90918	3VX630	55319	B148
2012080	3VX800	2010503	H8035	NYTODIN	B83	90920	5VX1000	55335	B158
2016068	B55	2010519	H8035A	NYTODIS	B85	90954	BB120	55350	BB158
2017025	3R/3V670	2011400	H87656	NYTODMAI	B128	90956	B46	55368	B162
2017641	C68	2012079	H87656A	NYTODMAT	B120	HAMMERSMITH		55400	B169
2019500	C162	2012080	M12072C	NYTODMCA	B162	H158	C158	55418	B173
2021649	C128	2016068	M12072D	NYTODMRN	B173	R.A. HANSON		55426	B180
2028263	B105	2017025	M12115	NYTODMSI	B157	HAN1220	D122(2)	55434	B180
2029726	A51	2017641	M12115A	NYTODMTS	B105	HARNISCHFEGER		55442	MXV4-580
2030165	B67	2019500	M12243A	NYTODMUX	B144	7Z292D13	B46(2)	55467	B218
2031847	3V600/4	2021649	R13115	NYTODMXA	B112	HARRIS HARVESTER		55475	B205
2032170	C144	2028263	R13115B	NYTRODPN	B93	75392	B65	55541	C53
2032177	B35	2029726	R13115C	NYTRODPP	B97	75650	CC195	55558	C75
2032178	B53	2030165	R13251A	NYTRODPT	B90	75653	C128	55566	CC81
2032182	C144	2031847	R13251B	NYTRODRI	B78	76622	C132	55574	C96
2032183	A40	2032170	R15054	NYTRODRS	B75	76623	B57	55582	CC112
2032193	B300	2032177	S16034	NYTRODRS	B56	78057	B90	55590	C120
2032201	A40	2032182	60108	NYTRODSC	B51	79648	B144	55608	C136
2032202	B120	2032183	61804	NYTRODSM	B51	79718	B195	55616	C144
2032208	C105	2032193	10 E 100	NYTRODST	B50	82875	B210	55624	C146
2032211	A35	2032201	126965DF	NYTRODST	B50	7694998	BB128	55632	C149
2032215	C90	2032202	C102	NYTRODSX	B55	W76624N	C162(2)	55640	C153
7540348	A51	2032208	13 E 13	NYTRODUA	B42	W7806N	B85	55657	C158
13 F 8	C96	2032211	13 E 13A	NYTRODUI	B48	W79109N	B42	55665	C162
13H130	B83(6)	2032215	13 E 670	NYTROEMAI	C128	GOOSSEN INDUSTRIES		55673	C162
13H13A	3V900(8)	7540348	13 F 27	NYTROEMPS	C195	GB223	3R/3VX315	55681	C175
16E2000	B60	13 F 8	GILMORE - TATGE MFG.		NYTROEMRN	PB123	3VX450	55699	C173
17H2570	3VX500	4216123	B81	NYTROEMSI	C158			55707	C177
17H257A	A90	4216124	B88	NYTROEMST	C149			55715	C180
17H257C	A85	42110100	B68	NYTROEMXA	C112				
17H366	B71	42210144	B51	NYTROEMXI	C118				
17H3660	B71	42510045	B60	NYTROEPC	C96				
		FAN	B120	NYTROFPN	B93				
		B112	B112						
		B173	B173						
		B55	B55(2)						



WARNING: These products can expose you to chemicals including carbon black which is known in the state of California to cause cancer, birth defects or other reproductive harm. For more information visit www.P65WARNINGS.ca.gov

AG EQUIPMENT & PUMP BELTING PART NUMBERS

NOTE: FHP Belt may be upgraded to the MXV Belt, however the FHP Belt SHOULD NOT be substituted for the MXV Belt

Alphabetical sequence by manufacturer

OEM #	Belt No.	OEM #	Belt No.	OEM #	Belt No.	OEM #	Belt No.	OEM #	Belt No.
HESSTON		57513	CC154	856294	C98	700705773	B57(2)	B4B5HM	B73
55723	C180	57554	C144	856310	C116	700709333	C180	B4B6	B60
55731	C197	57562	B94(2)	856369	C177	700709625	B76	C4B1A	C124
55749	C195	57596	C78	856385	C101	700710498	B79	F4B1A	D140
55764	C204	57604	C46	856401	C105	700711239	B173	F4B3	D128
55772	C210	57661	B72	856435	BB300	700714140	B131(2)	F4B4A	D101
55780	C225	57695	C150	856476	C70	703006230	B79(3)	HOB TOOL	
55790	C225	57703	C87	856492	B52	703013560	C83(2)	113039	B300
55798	C240	57711	C113	856500	C124	703013835	C83(3)	113040	B350
55804	C86	57749	C345	856542	B44	703062165	B71	HOBBS ENGINEERING	
55806	C255	57752	B75(2)	856559	C90	10971FA	B42	4184	BB128
55822	C270	57786	C131	856625	C190	1BB58	BB158	A105	A105
55830	C313	57794	C173	856633	C118	56325A	C75	HUTCHINSON DIVISION	
55848	C320	57810	C140	856641	C98(3)	855718A	5VX800	30150	A50
55855	C330	57836	B69	856732	B74	B195	B195(2)	32046	B46
55863	C345	57844	C81	856757	A95	B57	B57	32048	B48
55871	C360	57851	C158	856831	C120	C120	C120	32050	B50
55889	C390	57893	C107	856849	A46	HS1000C	C96	32057	B57
56028	B57	65218	B69	856872	B60(2)	S0409B	B38	32060	B60
56036	B77	69704	B81(2)	857193	B120	S0522C	C51	32071	B71
56044	B83	117638	A25	857219	C128	S0539CS	C51	32081	B81
56085	B146	261149	C75(2)	857243	C295	S0792C	C75	32088	B88
56127	B185	261461	C72(2)	857250	3VX375	S0860B	B83	320100	B100
56184	C78	262600	CG158(2)	857276	3VX800(2)	S0879B	B85	320103	B103
56192	B53	264069	5VX850(2)	857287	C375	S0900B	B87	320120	B120
56226	C81	272633	C83(3)	857326	5VX850	S0971FA	B42	5115646SA	B83
56234	5V2240	285320	A55(2)	857359	B92	S1162CC	CC112	6BB0	BB60
56242	B97	316620	B69	857367	5V1000	S1229BS	B120	B105	B105
56259	C136	324616	B63(3)	857375	B39	S1360B	B158	B134	B134
56325	C75	335687	B72(2)	857383	B35	S1469B	B144	B210	B210
56333	CC112	413070	BX55(2)	857417	MXV5-108	S1509B	B144	B42	B42
56408	A46	486274	B94(2)	857482	C-112	S1522C	C149	B52	B52
56424	B83	566068	C144	857516	C112	S1622C	C158	B54	B54
56465	B180	785513	A52	857581	A50	S1648C	C160	B62	B62
56549	C60	785521	B61	857664	B81	S1703B	B173	B64	B64
56564	C162	828004	A51(2)	857672	B83	S1959B	B195	B66	B66
56580	C162	855007	C149	857714	B140	S1992C	C195	B71	B71
56606	C144	855031	C73	857763	A33	S2080B	B221	B79	B79
56630	5V2360	855049	C131	857805	B72	S2210B	B221	C103	C103
56648	C173	855056	C76	857862	C90	HEVKO		HYDRA MAC	
56655	C162	855064	C65	857870	B75(2)	9000034	C54	2000032	BX69(2)
56663	C285	855072	D285	857920	C149	HINIKER (FOX BRADY) (KOEHRING)		IMPERIAL STEEL	
56671	C228	855080	C188	857938	B44	1019	C78	PL201	B270(2)
56681	C285	855106	C98	857946	B46	25012	C79(2)	PL201B158	B158(2)
56705	B168	855239	B1750	857979	A68	25034	B51	PL201B195	B195(2)
56713	B192	855247	B41	857996	C100	25097	A56(2)	INDUSTRIAL ALBAJAR	
56770	B81	855254	C57	857998	BX55(2)	25151	C73(2)	17X2880	BB111
56788	C229	855320	B43	858026	BB85(3)	25168	C81(2)	INGALLS MFG.	
56796	C360	855346	C55	7855034	C85	51600012	AX59(4)	A68	A68
56798	C225	855379	BB85	7855208	A50(2)	51600019	B83	B124	B124
56804	C69	855395	A58	7855216	A57	51610015	A57	B68	B68
56812	CC158(2)	855403	C109	7855240	AX62(2)	51610016	A44	B70	B70
56838	B124	855409	C131	7855257	B84	51612003	B48	B81	B81
56853	B90	855577	C158	7855265	BB108	51612005	B58(3)	INNES	
56895	C177	855601	C156	7855315	B109	51612020	B64	211621	BB128
56911	C90(2)	855619	A26	7855331	C107	51612025	B32	211622	BB105
56945	CC96	855627	B46	7855356	B59(2)	51612026	B68	2052748	C70
56978	C215	855643	CC224	7855380	B140	51614009	C59	2052772	C73
56986	C128	855650	B73	7855489	B61	51614010	C66	2052775	C73
56994	C72	855726	C113	7855498	A53	51616000	D92	2052790	C75
57026	C60	855767	C183	7855513	MXV5-640	51616002	D140	2052820	C78
57034	B60	855791	C188	7855521	A100	51616006	D151	2052840	C81
57141	C83	855833	B42(2)	7855539	B60	51616009	D151	2052880	C85
57158	BB105	855866	C85	7855547	B60	700001223	C115	2052980	C94
57166	C63	855874	B46	7855562	3V475	5M4B2A	B83	2500445	B42
57174	C80	855916	A96	7855604	C98	5M4B2B	B91		
57216	B72	855932	B72	7855646	C141	B4B1	B85		
57273	A55	856021	B58	7855679	5VX900	B4B2	B49		
57307	B170	856039	A89	7855687	B92	B4B3	B51		
57323	C255	856054	A106	7855729	MXV4-800	B4B5	B73		
57349	C330	856088	C144	7855745	C110	B4B5A	B71		
57364	B98	856120	B54	7855752	B33	B4B5B	B75		
57398	B109	856138	B65	7855935	A35				
57448	C77	856146	C99	70070578	A56				
57455	C59	856161	B107	70509860	B58				
57471	C103	856187	C154	78508363	B146				
57497	C188	856195	B50	700704407	B49(2)				
				700705430	B148				



WARNING: These products can expose you to chemicals including carbon black which is known in the state of California to cause cancer, birth defects or other reproductive harm. For more information visit www.P65WARNINGS.ca.gov

CROSS-REFERENCE - AG EQUIPMENT

AG EQUIPMENT & PUMP BELTING PART NUMBERS

NOTE: FHP Belt may be upgraded to the MXV Belt, however the FHP Belt SHOULD NOT be substituted for the MXV Belt

Alphabetical sequence by manufacturer

OEM #	Belt No.	OEM #	Belt No.	OEM #	Belt No.	OEM #	Belt No.	OEM #	Belt No.
INNES		1108436	B81	AL1922N	C87	E17844	C73	H131169	C255
2500807	B78	1177759	3VX600	AM31159	MXV4-280	E20254	C67	H132808	B53
2500890	B86	1177792	A49	AM32172	MXV4-350	E30472	D82	H134437	XPA1457
2502748	C71	1240435	B68	AM32636	MXV4-360	E30481	D125	H135380	C184
2502772	C74	1240436	B55	AN103488	A92	E30724	C67	H135458	C313
8085900	5VX900	1245715	B51	AN115162	B78(2)	E31690	C54	H136881	C124
20521000	C96	1261356	B62(2)	AN150062	3V475(2)	E33446	C57	H136963	C120
20521020	C98	1266825	3VX600(2)	AN15112	B68(3)	E36784	C63	H137830	C313
20521040	C101	1268787	B51	AN15113	B81(2)	E37644	C126	H138761	C128
20521075	C103	JOHN BLUE		AN15234	5V1250(2)	E37905	C94	H138762	C131
20521125	C108	A2215	A33	AN190948	C77(2)	E38125	C87	H140160	D169
20521135	C110	JOHN DEERE		AN194750	B92	E38587	C163	H141166	C321
20521155	C112	22	A28	AN194751	B92	E39041	C107	H141167	C320
20521190	C115	2058	MXV4-300	AN194916	C93	E39166	C93	H146636	MXV4-400
20521220	C117	15202	A64	AN194917	C97	E39525	B62	H146637	MXV4-410
20521395	C136	44178	3L290	AN30712	C112(2)	E39526	C126	H151952	D164
25001025	B100	48444	BB140	AN30712N	C112	E39612	A112(2)	H160171	C322
25001055	B103	141167	C321	AN30713	C108(2)	E39661	C116	H20406	CC118
25021675	C164	A240077	D147	AN30719	C115	E39739	C54	H20407	C113
25021990	C195	A2745R	A32	AN30720	C110	E39792	A47	H21233	C203
80501030	B100	A862667	B44(2)	AN30759	C80	E40574	C112	H21666	B62
80501080	B105	AC12113	B114	AN30760	C81	E40625	C117	H21884	B162
80501150	B109	AC15149	C111(3)	AN30761	C106	E4304E	B78	H21925H	C124
80501225	B120	AC24118	A113(2)	AN30761N	C106(2)	E43565	C152	H21929	B91
80501305	B128	AC24122	A112(2)	AN30762	C108(2)	E4373E	B57	H21929H	B92
80501355	B133	AC24128	A98(2)	AN30763	C103	E4461E	B87	H22195H	C124
80501425	B141	AC27650	B108	AN30908	C89	E46113	C83	H22529H	B120
80501465	B144	AC28944	B80(2)	AN31374	C103(2)	E46806	C60	H23178	B87
80501575	B154	AC31988	B108(2)	AN31375	C114	E46844	C49	H23190	B85
80501610	B158	AC40984	C102	AN32762N	C90(2)	E46847	C106	H23373	C60
80501645	B162	AC91E	3VX670	AN33240	A36(2)	E48062	C87	H23725	B37
80501755	B173	AE29066	C195(3)	AN33240N	A36	E48310	B80(3)	H23766	C70
80501825	B180	AE45931	C195(3)	AP24777	A44(2)	E50237	C104	H23770	C92
80501970	B195	AE48912	BB79(2)	AP26684	A35(2)	E50924	C195	H23771	C117
80502410	B240	AH112086	C69(2)	AP26684H	A35(2)	E51284	B108(2)	H23817	C89
80502850	B285	AH120820	A57(2)	AR29285	A40	E51727	C57	H23927	D122
80901530	C148	AH120918	C75(2)	AR43648	A53	E51728	C54	H23928	D146
80911540	B151	AH127866	C90(2)	AR53099	B62(2)	E52179	C59	H23950	C119
809221610	B158	AH131960	C73(2)	AR93009	B56	E52638	C51	H24457	B36
2500890A	B86	AH139436	C75	AT11535	3V280	E52646	C98	H24472	B96
JACOBS TOOL		AH14174	B74(2)	AT28030	SPZ1212(2)	E53108	C119	H24473	B46
DW170019	B55(4)	AH14175	B68(2)	AT30181	B57	E53936	A67	H24650	C128
DW170033	B63(3)	AH14176	B60(2)	AT51740	B55	E54089	B106(2)	H24593	C55
DW170061	B49(3)	AH14178	B56(2)	AT59850	A60	E54541	A74	H25641	C156
DW17006320	B50(7)	AH15466	B51(2)	AW10254	C84	E55171	C199(3)	H25642H	B97
DW170071	3R/3VX425	AH15610	B64(2)	AX40190	AX35	E55668	C90	H25647	C99
JACOBSEN MFG.		AH16415	A39(2)	AZ12856	C61(2)	E58483	C107	H25990	3V375
348644	BX80	AH16415H	B62	AZ22534	B57	E58548	C131	H26082	CC146
JAMES MFG.		AH17515	A33(2)	AZ42064	C50	E60212	C100	H2620H	B112
PC134	A40	AH19544	C90(2)	AZ51087	C50	E60597	A56	H26858	B142
PC266	A68	AH19544H	C90	B13907	A52	E60598	A68	H26858H	B144
PC380	A51	AH19550	D83(2)	B14482	3L280	E61326	B50	H26887	C72
PC441	A98	AH20314	A37(2)	B14826	B72	E61749	A64	H27109	B60
PU289	A47	AH61301	C126	B14852	3L270	E63031	C108	H27351	B117
PU291	A33(2)	AH62667	B44(2)	B17267B	A55	E63036	C92	H27387	C70
JEBCO		AH62729	B46(2)	B27635	A31	E63957	C175	H27433	C86
3PT40	C75	AH62769	B45(2)	B28170	400J8	E69424	C66	H27568H	B64
3PT60	C77(4)	AH63075	C131(2)	C11078	C90	E69644	A58	H27955H	B51
JET FLOW		AH75079	D1885	C11088	B47	E69645	A70	H28671	CC116
621	B105	AH75634	C83(2)	C11508	C141	E70357	C138	H28682	C123
6109	B68	AH75638	D82(2)	C12831	3V500	E70675	C54	H28770	A39(2)
6132	A26	AH76154	C78(3)	C17334	B99	E72331	C94	H29528H	B44
JOHN BEAN		AH77644	B97(3)	C3471E	C45	E78287	A40	H29955	B51
1107401	A53	AH79627	C169(3)	C457D	B75	F13511	C214	H30735	D139
1107402	A55	AH79671	D83(2)	C458D	B65	FT427YW	A36	H31088	B58
1107406	A66	AH80500	B89(3)	C493D	A46	G6876E	C122	H31227H	B177
1108422	B46	AH80503	B102	CA20514	SPA1107	GG02032178	B53	H31228	B201
1108426	B55	AH80505	B97(3)	CA20518	B44	H101352	A64	H31267	B146
1108427	B60	AH87197	B62(3)	CA22534	B57	H101436	C132	H31267H	B144
1108429	B64	AH89436	C83(3)	CC18089	C61	H101469	C73	H31289	B153
1108430	B65	AH96300	C62(2)	E10801	C88	H103344	C274	H31289H	B152
1108432	B68	AH98052	C83(2)	E11623	C89	H110300	C150	H31328	C52
		AL7456N	C83(2)	E11837	C80	H111519	D158	H31329	BB68
		AL1549N	C85	E12574	C66	H112421	B133	H31330	A42
		AL1620N	C91	E14150	C64	H118730	C128	H32099	C198
		AL1660N	C93	E14507	C55	H125380	C184	H32118	C144
				E16774	C85	H125381	C171	H32801	C44
				E17465	C105	H128010	C188	H32802	C58
						H128234	B217	H33142H	D85



WARNING: These products can expose you to chemicals including carbon black which is known in the state of California to cause cancer, birth defects or other reproductive harm. For more information visit www.P65WARNINGS.ca.gov

AG EQUIPMENT & PUMP BELTING PART NUMBERS

NOTE: FHP Belt may be upgraded to the MXV Belt, however the FHP Belt SHOULD NOT be substituted for the MXV Belt

Alphabetical sequence by manufacturer

OEM #	Belt No.	OEM #	Belt No.	OEM #	Belt No.	OEM #	Belt No.	OEM #	Belt No.
JOHN DEERE		L1048C	B85	M47771	B112	N135786X	B50(3)	P40280	C47
		L1051C	A60(2)	M48444	BB140	N14014(N)	A44	P40281(H)	B55
H33314H	D105(2)	L1111C	B51	M48520	MXV4-250	N150166	3V475(2)	P40965(H)	B42
H33473	C152	L1123C	C129	M49000	A62	N15020	A49	P41480	CC121
H33695	C65	L1151C	A68	M49920	MXV4-990	N150202N	A64	P41500	B33
H34740	C114	L1199C	A90	M81035	MXV4-350	N15020N	A50	P41508	C62
H34944	D173	L1266C	B68	M81036	MXV4-330	N15079	D85	P41603	C106
H35434	C77	L1293C	C157	M81037	MXV4-320	N1520N	5VX1250(2)	P41603H	C105
H35666	C206	L1293C	C158	M81805	MXV4-490	N15201(N)	C60	P42126	CC120
H35680H	D144	L1305C	B75	M81954	C283	N15202(N)	A64	P42182(H)	B113
H62164	D88	L1309C(W)	A85	M81976	C274	N15289(N)	B88	P42817	C83
H62258	C69	L1319C	B158	M82167	MXV4-510	N15315	A54	P42877	D85
H62990	A41	L1323C	B105	M82258	MXV5-400	N15315N	A55	P43202H	B42
H63010EB	C130	L1328C	B112	M82362	A85	N153524	400J12	P43323	B58
H63370	C161	L1329C	B120	M82460	MXV4-660	N15354	C67	P43532	C52
H63478	C101	L1352C	C51	M82461	MXV4-390	N154241	320J12	P43794	C90
H63938	B62	L1353C	B68	M82538	A61	N15432	C321	P44774	B187
H63939	B64	L1473C	C51	M82612	MXV4-360	N15527(N)	A58	P45928	C183
H64045	B128	L1474CH	C58	M82719	MXV4-490	N15528	B68(3)	P4611H	A90
H64483	C158	L1611C	C128	M82720	MXV4-450	N15697(N)	A60	P46343	A76
H64484	C169	L1711C	B78	M82734	MXV4-600	N157368	400J10	P46676	B47
H64834	D133	L1714C	A37	M82768	A117	N15898	B158	P46873	D140
H65121	3L310	L1723C	B90	M83556	C183	N1677	C85	P47192	CC126
H65434	C75	L1884C	B75	M83837	MXV4-880	N170856	C94	P47304	B41
H76028	D128	L1887C	B34	M84075	MXV4-790	N220907	B76	P47397(H)	B79
H76136	C57	L1888C	B136	M84136	MXV4-1010	N221266	A108	P47885	C109
H76150	C61	L1894C	B82	M84223	MXV4-620	N221414	B95	P47962	CC137
H77010	C175	L1899C	B59	M84505	B148	N30429N	C125	P47962H	CC136
H77291	C78(3)	L2217C	B48	M85442	MXV4-440	N30716	C138	P47982	C84
H77331	C134	L2218C	B54	M86060	MXV4-430	N30716N	C140	P48083	B42
H77765	D151	L2366N	C103	M86248	A101	N31193	D92	P48084	C64
H77766	C153	L3146N	B50	M86421	MXV4-530	N31233(N)	C75	P49204	C59
H78648	C106	L3700N	C114	M86422	MXV4-630	N31419(N)	C90	P49205	CC107
H79073	C100	L4276N	V83	M87373	CC150	N31437	C87	P49414	C133
H79236	SPA1600	L4277N	C85(2)	MSB606Z	B53	N31708(N)	B53	P49415	C94
H79237	A63	L4319N	C77	N10068(N)	B60	N31877	D92	P49416	B41
H79285	B136	L4490N	C78	N101027	D95	N32248	B55	P49570	B38
H79787	C210	L4491N	C86	N10179	A41	N32249(N)	B66	P49603	B49
H79788	C131	L4512N	C84	N10192(N)	B68	N33314	C73	P49603H	B50
H79789	C225	M139116	1922V554	N107439	C100	N33746	B82	P49604	B92
H79795	C184	M40013M	A35	N110051	C126	N34820	D104	P49729	B42
H79917	C108	M40014M	A66	N110084	C72	N34821	D95	P49938	B80
H80103	C131	M40222M	A26	N110085	C128	N34881N	A36(2)	P49938H	B81
H80159	B110	M40223M	A85	N11057	B83	N35158	C72	P50335	C129
H80632	C58	M40224M	A55	N11057N	B85	N51225(N)	B35	P50471H	3V450
H81222	C148	M40757M	A75	N11117(N)	A72	N51289(N)	B88	P50749	B74
H81378	A49	M41140	B123	N111527	C69	N51290	B91	P51164H	A35(2)
H81524	C111	M41244	A51	N114301	B43	N51461	B84	P51165H	B64
H81653	C245	M41592	MXV4-400	N115368	B45	N52188	B86	PR1528R	3L200
H81975	B89(2)	M41642	MXV4-620	N11602	A40	N52547	C89	R29474	A34
H82311	A74	M41668	MXV4-980	N117398	B46	N7100DN	B84	R3808N	B92
H82318	A70	M1672	A60	N120036	C87	N85311	3V425	R4677N	B112
H83715	C128	M1960	MXV4-1020	N120087	C80	P19984	C67	R4678N	B110
H86039	A68	M42261	A58	N120289	B117	P24148(H)	C210	R4679N	B108
H86060	A70	M42485	MXV4-460	N120494	B125	P25217(H)	C100	R63900	A40
H86061	A74	M43489	MXV4-570	N120715	B153	P27108	B159	R64760	B92
H87256	C128	M43490	B112	N120716	B107	P27108H	B158	R69955	A43
H87648	C106	M43569	MXV4-500	N120717	B103	P28905H	A90	R70446	B57
H87648	C149	M43586	MXV4-680	N120718	B105	P29286(H)	B84	RL1328N	B112
H92080	C274	M43795	MXV4-410	N120719	C84	P29287H	B93	T12551	3V475
H92136	C131	M43820	MXV4-740	N120847	B121	P29786	C248	T16405	C390
H94254	B133	M44121	MXV5-670	N121113	C103	P30120	CC240	T20161	B47
H96414	C68	M44178	MXV3-290	N121114	C98	P32058H	B105	T20334	B46
H97929	D186	M44272	MXV4-800	N121114	C98	P32361	B147	T23505	B44
J15342(HN)	A46	M44483	MXV4-480	N121116	C81	P33316H	A75	T31710	B51
J16464	B51	M44498	MXV4-600	N121235	C183	P35021	B148	U46257	A29
J17878(N)	B75	M44758	MXV4-360	N121448	B113	P35760	B97	W10389	C95
J18038(N)	B67	M47766	MXV4-800	N121874	B147	P35760H	B98	W1039	C96
J18038(N)	(N-HD)	M47770	MXV4-500	M44750	3L310	P36187	CC147	W10403	C84
J18470	C128(2)			N123657	A88	P37230	A41	W12904	BB112
J18477	B78			N124017	C167	P37230H	A42	W14431	B83
J18796(N)	B73			N125041	C106	P39388H	C85	W15193	A18
J19214(C)	B75			N12551(N)	C115	P39561H	B93	W25574	C32
J19497C	B75			N125885	C108	P39562H	B81	W30582	C60
J20475(N)	B54			N128466	C122	P39565H	B85	W36143	B90
J20918	B103			N128809X	A33	P40017	C104	XH132808	B53
J9836H	A90			N129508	C169	P40023	C108	XH132809	B52
L1047C	C136			N129916	A103	P40278	C120	Z20460	C126



WARNING: These products can expose you to chemicals including carbon black which is known in the state of California to cause cancer, birth defects or other reproductive harm. For more information visit www.P65WARNINGS.ca.gov

AG EQUIPMENT & PUMP BELTING PART NUMBERS

NOTE: FHP Belt may be upgraded to the MXV Belt, however the FHP Belt SHOULD NOT be substituted for the MXV Belt

Alphabetical sequence by manufacturer

OEM #	Belt No.	OEM #	Belt No.	OEM #	Belt No.	OEM #	Belt No.	OEM #	Belt No.
JOHN DEERE		KEITH INDUSTRIES		KOEHRING (FOX BRADY) (HINIKER)		LILLISTON (SEE BUSHHOG)		4050130	C115
Z20562	C156	4022	A62	B4B5A	B71	918	B144	4050134	C164
Z20703	C118	4023	A45	B4B5B	B75	12727	B162	4050137	C185
Z20743	C83	4027	A39	B4B5HM	B73	12728	B158	4050142	C255
Z21137	A41	4028	A59	B4B6	B60	12730	B124	4050143	C270
Z21171	A49	4029	A96	B4B1A	C124	12731	B100	4050152	B285
Z21254	A53	4202	B112	F4B1A	D140	50183	B66	4050153	B92
Z21398	C68	4203	B91	F4B3	D128	150030	B100(4)	4050175	B245
Z21400	C69	4204	B81	SPF4B10	A55	150087	B112	4050176	B255
Z22208	SPA1257	4207	B103	SPF4B12	B58	150151	B112	4050185	C112
Z22832	B178	4215	A29	SPF4B2A	5VX1400	222279	C115	4050186	C144
Z23086	C322	4216	B140	WB4B1	A54	1550007	C128	20521020	C108
Z23087	C78	4303	C144			1550111	B148	20521075	C103
Z23376	C105	4304	C162			1550119	B144	20521125	C108
Z23693	C124	KELLEY MFG.		KOSCH		1550135	B56	25000662	B64
Z23752	A35	3053015	C152	K1006	C78	2750005	C131(2)	25000730	B70
Z24833	A57	3053031	C68	N1294	C83	3950006	C136	25001100	B108
Z25473	C67	3053034	C158(2)	K1386	C92	5550010	C152(2)	25001165	B113
Z25670	D166	3053035	C180(2)	K1825	C90	6050014	C146(2)	25001385	B136
Z26628	C71	3053038	C100	K2638	C72	6050050	BB107	25001515	B148
Z26888	C106	32053003	B87	K2639	C63	6050052	B108	25021125	C109
Z28458	C84	33053021	B60	K265	C48	6050208	CC157	25021395	C136
Z28842	D164	33053023	C144	K333	C60	6050209	C72	25021475	C144
Z30130	D150	33053051	B136	K3383	C112	50002705	C86	25021735	C173
Z30920	B172	3A53003	C144	K354	C51	50009469	C83	25021765	C173
Z31816	C128	3A53015	C152(2)	K3600	C195	50009471	C131	25021790	C175
Z32041	B187	3A53031	C68	K437	C53	50013184	CC155	25021870	C185
Z32158	B150	3A53034	C158(2)	K459	C70	03-053-031	C72	25022735	C270
Z32883	A109	3A53038	C100			33-053-023	C147	50901530	C149
Z33368	C88	KELLY RYAN		KRONE		33-053-025	C109	80501225	B120
Z33605	A114	22C99	C97	0921-506-0	3R/5V750	33-053-050	CC105	80501305	B124
Z33774	B175	M23C	B61	0921-523-2	SPB3225(4)	33-053-071	CC120	80501645	B162
Z34405	C116	KENT MFG.		KUBOTA		S1718	AA85	80501825	B180
Z34828	SPB1400	78B	B78	7005000060	3VX315	S2952	3VX250	80501970	B195
Z35356	C153	B144	B144(2)	7008000246	A110	S2954	3V250	80971755	B173
Z35965	A106	C51	C51	7008000247	A81	LOCKWOOD CORP			
Z36949	D188	C55	C55	7008000656	A90(2)	4056	B75	80971829	B180
Z38148	SPA1120	KINZE		7008000740	A90(2)	40517	B70	HBB180	A110
Z38149	SPA1400	G1K342	5VX710/4	7008000963	B71	40540	B48	10250001600	B157
Z38698	C90	KITSON POULTRY		7070634710	C109	40558	B153	L0040500212	A40
Z38702	SPA1232	25022140	C210	7071299180	B86	40582	B51	L0040500229	B116
Z38703	SPA1320	25022555	C255	7071334770	B81	40588	B157	L04050094	B120
Z38704	A87	KOEHRING (FOX BRADY) (HINIKER)		7072232430	B38(2)	40599	B42	L04050136	C180
Z41889	SPA1457	1019	C78	7072234710	B108	250772	C75	L04050141	C244
Z41932	B58	2502234710	B108	70080-00828	B71(2)	347750	BB75(2)	LA04050036	B60
Z42382	SPB1440	700-8001412	B81	KUHN		405105	B64	LONG MFG.	
Z42756	SPA1457	831-017-82HTS	SPB1590	831-017-87	SPB2500(3)	405120	B78	6971	C140(2)
Z42757	B55	831-017-915	B112(4)	KUKER		405125	B118	8128	B30
Z43253	C65	KUKER		1071A	A61	405129	C100	8129	B195
Z45026	B76	1071B	B64	L Aidig		405138	C195	14658	B173
Z45369	SPA1107	Laidig		30154	B75(2)	405140	C230	102868	MXV4-1050
Z45482	B56	30884	B60(2)	Landpride		405144	B81	106841	B87
Z46366	C121	Landpride		816-064C	B158	405148	B140	242691	B105(3)
Z46759	SPA1082	816-101C	C195	816-101C	C195	405155	C132	243210	B87
Z51212	D89	816-116C	B133	816-141C	B175	405159	BB128	722264	B140
Z7159H	C43	Lennox		Lennox		405170	C360	723644	B83
Z879914	C51	Lennox		P25562	B42	405172	C240	730697	C90
Z8800H	C46	Lewis		Lewis		2052772	C73	730698	C128
Z9281(H)	C45	B144	B144	B144	B148	2052790	C75	730699	C112
Z9333H	C435	B148	B148	B81	BB81	2500445	B42	730700	B78
Z9367H	C52	BB81	BB81	BB85	BB85	2500790	B76	730702	B112
JOHNSON FARM		JOHNSON FARM		JOHNSON FARM		2500977	B95	734364	B56
64109	B108	JOHNSON FARM		JOHNSON FARM		2500977	B95	B83	B83(2)
64158	B144	JOHNSON FARM		JOHNSON FARM		2502748	C72	C08097	A38
64338	B90	JOHNSON FARM		JOHNSON FARM		4050005	B78	C10054	A43
64452	B59	JOHNSON FARM		JOHNSON FARM		4050006	B75	HM12703	C108
66260	B46	JOHNSON FARM		JOHNSON FARM		4050030	B68	HM12704	C86
66394	B120	JOHNSON FARM		JOHNSON FARM		4050032	B64(2)	JE LOVE	
66439	B28	JOHNSON FARM		JOHNSON FARM		4050035	B112	A20436	C78
67572	B48(3)	JOHNSON FARM		JOHNSON FARM		4050036	B60	A20438	C83
K B H		K B H		K B H		4050041	B55	A20441	C108
K132	C156	K B H		K B H		4050055	B85	A20462	B54
KASTEN		KASTEN		KASTEN		4050093	B97	A20538	C96
7153	C75(2)	KASTEN		KASTEN		4050104	C96	B72	B72
		KASTEN		KASTEN		4050112	B173	CD1007V	C89
		KASTEN		KASTEN		4050114	B144		



WARNING: These products can expose you to chemicals including carbon black which is known in the state of California to cause cancer, birth defects or other reproductive harm. For more information visit www.P65WARNINGS.ca.gov

AG EQUIPMENT & PUMP BELTING PART NUMBERS

NOTE: FHP Belt may be upgraded to the MXV Belt, however the FHP Belt SHOULD NOT be substituted for the MXV Belt

Alphabetical sequence by manufacturer

OEM #	Belt No.	OEM #	Belt No.	OEM #	Belt No.	OEM #	Belt No.	OEM #	Belt No.
JE LOVE		K26316	C124	K9530	C94	1043916M1	C134	185223M1	A51
CD1008V	C77	K26324	C123	K9531	B221	1044000M91	B119	1855008M1	C74
CD1013V	C85	K26561	B68	MAIZE		1044001M1	A46	190083M1	A49
CD1014V	C136	K28030	C108	MASSEY FERGUSON		1044181M1	B108	195432M1	C104
CD1031V	C101	K28031	C103	3003925	5VX800	1045252M1	C47	195433M1	C97
CD1033V	C99	K29384	C113	2318	B60(2)	1047702M1	B122	195434M1	C112
CD1034V	C94	K29695	C158	3568	B70	1049602M1	C103	195488M1	C72
CD1035V	C90	K29914	B75	35274	C150	1050700M1	C94	195671M1	C90
CD1036V	C92	K29915	B90	55541	C51	1051235M1	C352	195672M1	C101
RVC105	C105	K29917	B32	55681	C173	1052006M1	A91	195899M1	C66
RVC134	C130	K29918	B100	252828950	B112	1052007M1	A54	200327M1	B97
RVC68	C68	K29919	B158	*1056877M1	C109	1052371M1	A35	200432M1	C102
XCD1038V	C93	K29920	B55(2)	*541372M1	B101	1052602M1	B108	200557M1	B103
LUEDKE		K32360	B32	*57292M1	C101	1053399M1	C71	201900M1	C128
203004	BB112	K4224	C51	055562M1	B221	1056409M1	B105	202242M2	B63
LUNDEL		K4226	B138	100261M1	A48	1056423M1	B190	202336M1	B72
2190L1	B162	K4227	B180	1008980M1	C144	1056522M1	A49	202961M1	C140
2886L1	B70	K4228	B60	1012134M1	B85	1056732M1	A126	203052M1	B92
2887L1	B78	K4436	C229	1012435M1	A80	1056841M1	B68	203437M1	B47
C180	C179	K4441	A46	1014342M1	B144	1056914M1	C103	203551M1	B104
MACDON		K4540	C223	1014979M1	C188	1071174M1	B118	204084M1	B106
34400	34400	K4541	C235	1014980M1	B136	1077008M1	B120	204095M1	B118
114006	C140	K4542	B66	1014981M1	B175	140114M1	B185(2)	204618M1	A136
K11654S	5VX670	K5050	B126	1015003M1	B225	140235M1	B199	204619M1	A119
K1171	B87	K5458	B226	1021521M1	B40	140254M1	C54	205235M1	C126
K11781	B52	K5460	B73	1023436M1	MXV4-290	140259M1	B57	206020M1	C106
K11801	B64	K5461	B71	1023531M1	A50	140260M1	B53	206021M1	C117
K11839	B195	K5462	B91	1023564M1	MXV4-250	141485M1	B144	206152M1	C120
K11840	B49(2)	K5463	B97	1023608M1	MXV4-290	141514M1	B185	206191M1	C140
K11853	A76	K5464	B208	1024562M1	A29	141515M1	B210	206897M1	C46
K13313	B49	K5563	B79	1025542M1	MXV4-500	141653M1	B120	210075M1	C108
K13641	B212	K5566	B84	1027577M91	B60	141654M1	B136	210615M1	B91
K13662	A71	K6078	B44	1030050M1	MXV4-490	141883M1	A70	210627M1	B86
K13701	B133	K6108	B25	1030912M91	C111	141899M1	C285	210628C1	B81
K13712	B217	K7095	B232	1031520M1	BB128	141943M1	B138	210635M1	C75
K13721	B125	K7096	B69	1032834M1	A70	142218M1	B146	210716M1	B57
K14661	B119	K7097	B66	1032843M1	MXV4-720	142416M1	B150	210774M1	C96
K15068	B146	K7098	B237	1033077M1	C128	142566M1	C69	210775M1	C108
K154	B51	K7329	B81	1033078M1	C213	1441719M1	B44	210810M1	B51
K15433	B92(2)	K7330	B78	1033097M1	C202	1445437M1	SPB3000	211097M1	B87
K15652	B48	K7331	B75	1033137M1	C331	144719M1	B44	211098M2	C121
K15654	B243	K8404	B133	1033198M1	C362	144720M1	B95	211666M1	C93
K15655	BB51	K8405	B140	1033199M1	C343	144721M1	B257	211740M2	B32
K15656	B237	K8406	B65	1033198M1	C362	147365M1	C94	212135M1	C117
K15657	B196	K8407	B68	1033199M1	C343	147366M1	C93	212235M1	C117
K15981	B246	K8554	B144	103319M1	C120	1483860M1	C53	212397M1	C100
K15982	B49	K8555	B76	103320M1	C210	1483881M1	C91	212520M1	C154
K160	B162	K8556	B63	1033376M1	C328	1506425M1	C151	213008M1	C128
K16664	B94	K8557	B200	1033451M1	C172	1506444M1	C188	213469M1	C153
K17082	B221	K9501	B131	1033553M1	C320	1507294M1	B79	213850M1	B90
K17555	B33	K9502	C96	1033731M1	B162	1507296M1	B74	214732M1	A32
K17573	A162	K9504	A51	1033785M1	B195	1507297M1	B71	216286M1	C112
K17838	B255	K9505	C76	1033813M1	C270	1507299M1	B85	216897M1	A70
K17951	3L490	K9507	B82	1034187M1	C164	1507300M1	B91	220773M1	B94
K18117	B280	K9508	B57	1034188M1	C180	1507301M1	B97	221697M2(SET)	A71
K18980	C60	K9509	B171	1034707M1	A53	1507772M1	C194	221697M2(SET)	B87
K19451	B123	K9510	B103	1035252M1	C184	1508593M1	B81	222120M1	C75
K19452	B137	K9511	A35	1035285M1	C313	1508602M1	B78	222278M1	C66
K19468	3L420	K9512	B173	1035406M1	C230	1508609M1	B75	222279M1	B112
K19979	B213	K9513	C81	1035667M1	B60	151134M3	C103	222280M1	A65
K199791	B210	K9514	A108	1035690M1	A60	151335M1	A59	222295M1	B90(2)
K20045	A40	K9515	B103	1036940M1	C348	151812M1	B36	222347M1	B80
K20047	C105	K9516	C78	1037237M91	2R3VX800P(6)	152259M1	C100	222348M1	B62
K20104	B144	K9517	C73	1037667M1	B60	1604055M1	C61	222666M1	C109
K20567	C68	K9518	A96	1039570M1	B60	1604401M1	B147	222882M2	B60
K20568	C103	K9519	A32	1041487M1	B120	1604524M1	SPA1264	222917M1	A38
K205681	C98	K9520	B154	1041598M1	B252	1615254M1	C163	223006M1	B102
K20701	C136	K9521	C92	1041614M1	A71	1615333M1	C150	223336M2	A43
K20721	B108	K9522	B187	1041621M1	B180	1616447M1	B47	223346M1	B118
K22004	B119(2)	K9523	B53	1041621M1	B180	1616477M1	B49	223590M1	B149
K220041	B120(2)	K9524	B148	1041658M1	B119	1680230W1	B230	223591M1	A156
K24209	BX54	K9525	A48	1041659M1	B144	1720488M1	C116	223710M1	C129
K24879	A49	K9527	A42	1042395M1	B83	1720674M1, M2	B54	223991M1	A147
K248791	A55	K9528	B93	1042396M1	B32	1721710M1	SPA2900	227455M1	C126
		K9529	B194	1042873M1	B61	1722835M1	C80	227457M1	C73
				1043047M1	A92	1724154M1	C105	227976M1	B51
				1043214M1	A175	1764410W1	A76	227984M1	C143
				1043915M1	B215	182715B1	B43	227986M2	B178



WARNING: These products can expose you to chemicals including carbon black which is known in the state of California to cause cancer, birth defects or other reproductive harm. For more information visit www.P65WARNINGS.ca.gov

CROSS-REFERENCE - AG EQUIPMENT

AG EQUIPMENT & PUMP BELTING PART NUMBERS

NOTE: FHP Belt may be upgraded to the MXV Belt, however the FHP Belt SHOULD NOT be substituted for the MXV Belt

Alphabetical sequence by manufacturer

OEM #	Belt No.	OEM #	Belt No.	OEM #	Belt No.	OEM #	Belt No.	OEM #	Belt No.
MASSEY FERGUSON									
228113M1	C57	410919M1	C111	621262M1	B48	833674M1	C79	923640M1	5VX1400
228147M91	C117	410957M1	C67	621588M1	C113	833734M1	C97	924327M1	B60
228542M1	A166	410958M1	C62	665630M1	C105	833742M1	B98	924329M1	C195
228722M1	B51	410959M1	C92	668019M1	C50(2)	833854M2	B115	924623M1	B64
228813M1	C57	411020M1	B38	669452M91	B42(2)	833855M1	B214	924769M2	5VX360
228813M3	C58	411125M1	SPZ1687	675576M1	B93	833860M1	C210	925726M1	3L220
228873M3	C57	412074M1	B58	676135M1	C111	833861M1	B89(2)	926755M1	B136
228997M1	B47	412236M1	C112	676161M1	BB94	833867M1	A56	927739M1	5VX1250(2)
228999M1	B72	412399M1	C66	676448M1	B77	833869M1	A53	933139M1	3VX500(2)
229096M1	B161	417468M1	B53	677653M1	B131	833870M1	A51	933245M1	B151(2)
229097M1	B89	417660M1	B126	677654M1	B124	833872M1	C161	933505M1	B86(2)
229287M1	A163	417795M1	B85	677656M1	B69	833962M1	C115	933550M1	3VX315(2)
229288M2	A161	417797M1	B48	677664M1	B86	834032M1	B43(2)	947580M1	B70
229627M1	B38	417974M1	C107	687838M1	B88	834057M1	C87	948457M1	5V2000(5)
230380M1	C54	418209M1	C64	687841M1	B90	834058M1	C86	995514M4	B77
230381M1	C52	418900M1	B49	687995M1	B45	834111M1	B103	GB5123	A134
232508M1	C50	422790DA	A51	687996M1	C89	834139M1	C71	GB5254	A127
232521M1	B94	422792DA	A92	689454M91	B39	834140M1	C142	GB5294	BB195
233950M1	B49	460533M1	B48	700634M1	A66	834148M1	A38	GH5045	B112
236670M1	A54	501060M1	B62	701111M1	B110	834170M1	B136	GH5027	B160
240575M2	B49	511275M1	MXV4-1020	703298M1	B110	834190M1	C85	GH5038	B91
2439700WI	C167	511277M3	MXV4-500	703321M1	B73	834191M1	C102	GH5045	B68
2543650WI	C120	513316M1	A90	763775M1	A45	834254M1	B152	GH5046	B158
2614A158	SPZ1300	513790M1	3V900	764926M1	A32	834255M1	B156	GH5047	B53
2614B156	SPA1332	514132M1	MXV4-300	767141M1	A50	834264M1	A48	GH5067	B34
2619760W1	B67	514806M1	MXV4-350	767356M1	A47	834265M1	B53	GH5139	B29
2624080W1	A53	514808M1	A33	782849M2	C55	834332M1	MXV5-1000	GK5019	BB210
265522M91	A67(2)	514891M1	B67	782850M2	C52	834348M1	B42	GK5045	B124
273757M91	B156(2)	515382M1	1430V450	783907M1	B61	834492M2	B49	GK5094	D75
274015M91	B89	515383M1	1422V600	784170M2	B224	834518M2	C94	GK5098	C107
274339M91	A64	517965M1	A82	784796M1	C143	834729M1	A40	GK5105	B94
281560M91	B90(2)	518125M2	A38	784797M1	B51	834811M1	C98	GK5249	C121
2826795M1	B81	518223M2	A26	784926M1	A32	842110M1	B192	GK5262	C120
2835234M1	B56	519958M1	MXV4-770	785676M2	B191	842413M1	MXV5-590	GK5274	C150
2835857M1	B128(3)	521404M1	SPZ1480	785810M1	B152	842417M1	SPA1457	GL5152	B32
284632M91	A66(2)	523733M1	MXV4-360	790839M1	C170	842419M1	B156(2)	GN5101	B77
284633M91	A64(2)	523734M1	MXV4-580	795514M1	B77	842463M1	B48	GT5047	A114
285632M91	A64	523735M1	A95	830701M91	C52	842464M2	C62	TX2186	B100
291022T	B88	525932M1	A54	830702M91	C50(2)	842538M1	B79	TX6359	C209
3021192M1	MXV4-960	530669M1	MXV4-350	832085M1	C92	842796M1	SPZ1437	MAYRATH	
3021352M91	A41(2)	530756M1	A96	832446M1	B132	842809M1	C132	621022	B236
3021353M91	A37	531316M1	A90	832490M1	5VX530	842845M1	B78	627009	B292
3021546M1	3V355	537280DA	A43(2)	832526M1	A159	842851M1	B89(2)	A229	B58
3055094M1	B118(2)	537356M1	A27	832538M1	B80	842935M1	C51	A300	B297
3179419M1	3VX425	538241M2	A37	832597M91	A60	842991M1	B97	B77	B77
3180838M1	B105(2)	540027M1	B40	832599M1	A40	842992M1	C249	McCONNELL MFG.	
3180869M1	A96	541190M1	B143	832806M1	C61	843008M1	A64	GM81A	B38
320595M2	C54	541390M1	B75	832807M1	C98	843009M1	A65(2)	UT055178	B105
320596M1	B65	542304M1	B76	832822M1	B105	843029M1	C90	McKEE	
320623M2	B93	542456M1	B166	832832M1	C122	843302M1	C232	GB651	B65
321034M3	B120	542551M1	B88	832855M1	A154	843310M1	B238	MELOS MFG.	
322768M1	C52	542739M1	B168	832866M2	C214	843313M1	510J20	MB1	B97
324872M1	B52	545651M1	C210	832867M1	B133	843324M1	B97	MELROE	
326586M3	B245	545654M1	C85	832869M1	C86	843376M1	C194	6500720	5VX600
33145A	B42	550596M1	C97	832870M1	C118	843737M1	B51	6509084	B105
33365A	B40	556779M91	B44(2)	832871M1	C72	843742M1	B167	6515062	A29
334190M1	C85	581459M91	B45	832872M1	C128	843747M1	C216	6515624	A24
334332M1	B100	581460M1	B43	832876M1	B48	843749M1	C49	6541107	B83
3396253M1	3VX500	583576M1	BB136	832877M1	B57	843758M1	C244	6541108	B120
342388M1	A112	583601M91	B116	832878M1	C80	843759M1	C207	6541110	B120
343760M1	C195	583641M1	C93	832895M2	A35	843760M1	C195	6541111	B133
344306M1	A53	583824M1	BB120	832896M1	A60	843760M1	C195	6541112	B136
344307M1	A75	584849M1	C91	832896M1	A60	843811M1	C99	6541113	B144
35124A	B43	584850M1	B54	832906M1	C158	843845M1	B78	6541114	B85
401753M2	B193	610097M1	C48	832910M1	C49	843947M1	C251	6542201	B81
402177M1	B55	610470M1	C103	832922M2	A37	8440531M1	A66	6542202	B90
402188M1	B43	610506M1	C96	833011M1	C138	8440531M1	A53	6542203	B112
402354M1	C74	610506M1	C96	833061M2	C118	844307M1	A76	6542204	B124
402603M1	B130	610813M1	B89	833127M1	B136	844478M1	B82	6542205	B128
402604M1	B49	610841M1	C109	833128M1	C79	844496M1	C221	6542206	B185
402605M1	B78	610842M1	A142	833130M1	A172	844503M1	BB93	6542208	B158
402606M1	C103	610846M1	C42	833131M1	A178	844530M1	A64(2)	6542209	B173
402607M1	C96	611353M1	C131	833218M1	C62	844531M1	A66(2)	6542210	B180
403041M1	B46	611588M1	B96	833563M1	B175	850320M1	B35	6542211	B203
403071M1	B79	612258M1	B126	833564M1	B183	850349M1	C60		
405928M1	B248	612563M1	B88	833652M2	B61	852175M1	B36		
410195M1	SPZ2287	619317M2	C68	833655M1	A67(2)	893575M1	SPA1257		
		621258M1	B126	833656M1	A43	905481M1	B167		
		621259M1	C60	833665M2	B97	923190M1	3V355(4)		
		621261M1	B85	833673M1	B50	923639M1	B85		



WARNING: These products can expose you to chemicals including carbon black which is known in the state of California to cause cancer, birth defects or other reproductive harm. For more information visit www.P65WARNINGS.ca.gov

AG EQUIPMENT & PUMP BELTING PART NUMBERS

NOTE: FHP Belt may be upgraded to the MXV Belt, however the FHP Belt SHOULD NOT be substituted for the MXV Belt

Alphabetical sequence by manufacturer

OEM #	Belt No.	OEM #	Belt No.	OEM #	Belt No.	OEM #	Belt No.	OEM #	Belt No.
6542492	B31	575767	A26(3)	765025	C104(4)	2010514	B51	CP6497	BB75
6542493	B26	601301	B53(2)	856625	C190	2010517	B112	CP8165	3VX560
6542494	B58	635614	B60	2675401	B71	2010518	C99	CP9151	3VX280
6542495	B73	675402	B37	15A14072	C46	2010519	B135	VP1612	B49
6542496	B92	675804	B33	720080A	C185	2010520	C89(3)	PEERLESS	
6542540	B98	676262	B78	AK1874	B51(2)	2010521	C67	99708	B57
6542541	B106	703225	A45	F221636	C81	2010522	C81	8BB1	BB81(2)
6542542	B126	703344	A56	F240831	C136	2010523	A44	B42	B42(2)
6542543	B131	703345	A58	F7502685	C54	2010524	C57	B60	B60
6542544	B140	703346	A68	H143874C2	C51	2010525	C89	B70	B70
PICKUP1	A26	703885	A38	H143876C1	C69	2010528	C70	BB70	BB71
PICKUP2	A32	704322	C151	H210628C1	B81	2011044	C89	PENNINGTON	
MI - T - M		706239	17540	H210629C1	B69	2011400	C78	60	B50
400	A40	708897	A77	H545540R1	C72	2012079	3V800	714	B96
406	AX46	710417	B45	H668902R1	B77	2012080	3V800	156A	B140
MITSUBISHI		710495	C51	H55214	B71	2012085	B51	POLARIS	
4136718080	17385	710630	B192	K1705	B90	2012085	B53	176663	5VX1000
MONO MFG.		710693	C115	K2273	C72	2012088	B142	P1005V	5VX1000
B120	B120(6)	710712	C111	K3140	C120	2013413	C57	P1805V	5V1800
MOODY MFG.		710713	B136(2)	K3198	B105	2013609	C131	PB161	B158
B46	B46	710722	C108(2)	K3632	B62	2014617	B173	PB167	B166(2)
BB124	BB124	710976	B83	K4732	B68	2014618	B59	PB176	B173
MOOERS MACHINERY		710982	C147	K5009	B38	2015779	B120	PC1025	C99
1048	B48(4)	711541	C81	K5005	B41	2016068	B55	PC111	C106
1085	B85	711552	C86	OPPEL HARVESTER			2016085	PC116	C112
1090	B90(8)	711779	C90	A96	A96	2017641	C69	PC1315	C128
MORIDGE MFG.		711908	B124(3)	I1040	C144	2017862	3VX600(2)	PC1395	C136
381620	3V950	712133	C139(2)	I1071	B144	2019505	C162	PC1449	C140
381655	3V1400(3)	712180	B146	I1101	B180	2020054	3VX900/6	PC1475	C144
38244410	C105	712434	C124	I1185	C190	2020665	B109	PC155	C150
MOTT MFG.		712713	C140	I1586	C173	2021443	3VX375	PC165	C162
186	MXV5-470	712916	B43	I1613	B83	2021649	C123	PC181	C177
252	A31	714452	C160	I1614	B90	2021731	3VX600(2)	PC184	C180
276	3VX710	715398	C97(2)	I1686	C180	2025467	C111	PC188	C185
501	B144	716183	C154(3)	I1689 (M2)	C195	2027595	C96	PC1885	C189
526	B120	716288	C73	I1783	B173	2027596	C115	PC192	C195
527	B120	716640	C111	I1784	C75	2027921	3VX600	PC2125	C210
528	B66	717893	C131	I1791	C158	2028263	B105	PC228	C225
533	B46	719244	B210	I189	B112	2029656	A41	PC245	C240
535	B48	719662	C108	I190	B105	2029657	A45	PC2735	C270
557	B180	719715	C149	I1911	B158	2029726	A52	PC94	C90
102631	C50	719716	C160(3)	I195	B71	2031847	3V600/4	POWELL MFG.	
NEW IDEA		719722	C130	I196	B65	2032167	3VX315	38563	A85
12271	C97	720204	B148	I1969	C105	2032171	A54	PUG MFG.	
104486	B74	720217	B86	I1988	B100	2032172	C136	3211AA0843	1922V443
104617	B77	722017	C146	I2137	C60	2032173	C144	3211AA08430	1922V408
10477	B75	722378	C150	I2138	B133	2032177	B35	RAMACHER	
120174	A42(2)	722557	C115(2)	I2238	C85	2032178	B53	82842	B42
175403	B75	722622	C184	I32298	B68	2032182	C139	83048	B48
250278	C73	722649	C177	I3318	B120	2032183	A40	83268	B68
300943	B83	740171	D90	I3509	C210	2032187	3V560/6	83680	B80
302732	B47	740322	C151	I3535	B85	2032193	B300	84071	B71
302733	B49	740323	C186	I397	C112	2032201	A40	84283	B83
303107	B56	740323	B120	I398	B60	2032202	B120	84487	B87
303337	B96	741042	C149	I4389	B80	2032208	C105	84893	B93
303520	C103	741043	C152	I483	C120	2032211	A35	850112	B112
303834	B99	741044	C116	I1866	C128	2032215	C90	HB112	B112
305821	B40	742033	C101(4)	T187	B68	3010520	C88	HB42	B42
308301	B114	742036	C70(3)	OWATONNA MFG. (SEE GEHL)			3013413	HB80	B80
308302	C122	742037	C115(3)	2010240	C59	3013414	C57	HB81	B81
308303	C113	742527	C98(4)	2010242	A38	P K MFG.			
308636	B64	742562	B53	2010243	B126	CB64A	A64	REDBILL	
308637	B57	742562	C73	2010244	B140	GCSPPD35A	A35	PM11252	B52
400024	C140	742562	C82	2010245	B210	GCSPTM43A	A43	PM11355	B55
400194	CC136	743794	C81(4)	2010281	B195	PARMA			
400875	CC136	743795	C129	2010498	B150	1487	C83	PM11458	B58
526369	B87	743796	C132	2010499	B225	108303	B81	PM11550	B50
526370	B87	743797	C82	2010500	B103	145402	C50(2)	PM11760	B60
551155	C84(4)	743798	C82	2010501	B79	1013806	B136	PM11848	B48
551250	C66	743799	C82	2010502	B85	1410001	C96	PM11949	B49
571895	A91	743799	C82	2010503	B93	6000782	B82(2)	RENN (SEE MACDON)	
575377	B53	744831	C104	2010504	B74	14W14804	CC144	6B85	B85
		744831	C104	2010505	B71	BEN PEARSON			
		747254	C78	2010506	B63	CP10176	3VX600		
		747255	C144(2)	2010507	B67	CP10491	3VX400		
		747256	C72(4)	2010508	B68				
		760536	C105						
		760608	C98						
		760615	C100						
		761757	C98						



WARNING: These products can expose you to chemicals including carbon black which is known in the state of California to cause cancer, birth defects or other reproductive harm. For more information visit www.P65WARNINGS.ca.gov

CROSS-REFERENCE - AG EQUIPMENT

AG EQUIPMENT & PUMP BELTING PART NUMBERS

NOTE: FHP Belt may be upgraded to the MXV Belt, however the FHP Belt SHOULD NOT be substituted for the MXV Belt

Alphabetical sequence by manufacturer

OEM #	Belt No.	OEM #	Belt No.	OEM #	Belt No.	OEM #	Belt No.	OEM #	Belt No.
RIVINIUS INC.		60 X 6	B144	P TO TYPE	B97	50600026	C150	1406	B48
8371B7	BB60	60 X 7	B230	SPEEDY MFG.		50600027	C60	1407	BB68(3)
8372B7	B62	SHAW		B1516	C71	PB-1516	C72(3)	1409	MXV5-520
ROBIN NODWELL		B57	B57	R182	C74(3)	PB-1517	C75(3)	1471	B173
7098100035	A35	B65	B65	R184	C76(3)	PB-5435	C144(2)	1540	MXV5-400
7098100096	A96	S1666	A54	STARLINE		UTAH AGRICORP		1547	B46
7098100105	AA105	S1718	AA85	16340	B81	4HB940	B92	2726	B53
7098100120	AA120	S3472	A65	SHELLMAN		VAN DALE		2856	B85
7098110120	AA120	127	C149(2)	12701009	A100	90348	B95	3166	B100
7098200116	B116	B74	B74	STEIGER TRACTOR		675804	B33(2)	3227	B55
7098200120	B120	C60	C60	SUND MFG.		VERMEER		3334	BB105
RODGERS MFG.		HA100	A110	XB112	B112	1521001	B38	3335	BB55
5590	A51	SHINN		XB116	B116	1524001	B40	3429	B103
L777A	B75	7196	A96	XB124	B124	1534001	B47(6)	5266	B52
LR1284	BB68(2)	SIMPLEX MFG.		XB133	B133	1535001	B48	5963	B51(2)
ROOT MFG.		121378	A32	XB180	B180	1536001	C51	5964	B80(2)
A48	A48	SIoux STEEL		XB75	B75	1543001	B58	7163	B90
ROSKAMP MFG.		SIoux TOOL		XB80	B80	1547001	B68	7831	C81
112	B93(5)	SMALLEY		XB90	B90	1548001	C68	7832	B66(2)
ROTECH		SNOW CORP		XB93	B93	1550001	B75	7956	B65
20322800	C162	221954	B133	SUNMASTER		1554001	B85	7957	C81
87855730	B128	221974	B75	12760	BB144	1574001	C244(5)	8279	A47(3)
252928960	B57	A112	A112	94456590	B100	1575001	CC300(2)	8712	C120
702A53190	B48	A136	A136	SUPERIOR EQUIPMENT		1577001	C71	10205	C116
ROWSE HYDRAULICS RAKES		B144	B144(2)	B46	B46	10383001	B32	10612	B88
25581499	C99	B68	B68	B58	B58	224724001	3VX380	10705	B147
R1558141	C101	B70	B70	THIOKOL		90000630011	5VX670	12422	B83
R1558149	C101	SMALLEY		9000325	C68	C1287	BX85	13523	B315
S E SPRAY EQUIPMENT		SNOW CORP		9000326	C68	F410	C51	14376	B71
HB150	B150	221974	B75	THOMPSON		360721V1	A80	14665	B185
HB158	B158	A112	A112	B105	B105	360722V1	C110	14960	B91
S/G MFG.		A136	A136	B60	B60	360723V1	C83	14983	C98
PC301	A85	B144	B144	TOTE CO.		360724V1	B37	14984	C69
SAKUNDIAK		B210	B210	290319	B93	360725V1	B62	20481	B57
HD623	B195	B51	B51	294917	B85	360726V1	C90	20829	B51
HD629	B173	B60	B60	TRIPLE C		360727V1	C75	20830	B73
HD637	B225	B85	B85	B30	B30	5W3227B55	B55	20974	A40
HD641	B240	YJT1025	B83	B35	B35	777A	B73	22573	B36
HD733	B195(2)	SOUTH BEND FARM		B46	B46	C08711	C225	22925	B42
HD737	B225(2)	401398E	C68	B51	B51	CR6850	B63(2)	23491	B158
HD741	B240(2)	403657E	B75	SPEED KING		L1192	B240	25963	B51(2)
HD745	B270(2)	AP3402	B83	35253	B60	L777A	B75	28617	B105
HD837	B225(2)	SPEED KING		35279	B83	LA13523	B315(2)	28619	B158
HD841	B240(2)	35245	B51	35345	B51	LA14531	B270(2)	33375	B44
SCHULER		35493	B120	35493	B120	SW1376	B51(2)	35741	B53
134000	B133	35782	B73	35782	B73	SW1390	B71	35742	C83
134300	C136	A6001	B79	35782	B79	SW1406	B48	47613	B41
134500	C173	A6002	B93	35782	B93	SW1407	BB68(3)	51778	A46
411000	C105	B103	B103(2)	35782	B103(2)	SW1409	B71(2)	52631	B47
411096	C96	B106	B106(2)	35782	B106(2)	SW1471	B173	55266	A32
411099	C99	B112	B112	35782	B112	SW1547	BX46	59238	C131(2)
511459	C75	B128	B128	35782	B128	SW1547	BX46	61484	C105
580305	C156	B158	B158	35782	B158	SW2726	B53	62415	C63
GR134	B133	B75	B75	35782	B75	SW2856	B85	63215	B142
S134	B132	B90	B90(2)	35782	B90	SW3166	B100	64216	C146
S134C	C136	B93	B93	35782	B93	SW3227	B55	64223	C112(2)
SCOOP-ASECOND		B97	B97(2)	35782	B97	SW3334	BB105	64412	B96
24 X 6	B158	O3501405	B79	35782	B79	SW3335	BB55	64426	C106
30 X 6	B195	O3502205	B90	35782	B90	SW3429	B103	64551	C131
35 X 6	B230	O3504805	B97	35782	B97	SW5266	B51	64556	C69
35 X 7	B230	O3505505	B100	35782	B100	SW7163	B90	64571	B109
40 X 6	B270	O3519605	B38	35782	B38	SW956	B42	64845	A68
40 X 7	B270	O3540205	B68	35782	B68	SW957	B35	74557	B105
40 X 7	B270	O3562605	B108	35782	B108	VERSATILE		77115	C253(2)
50 X 7	B270	O3571005	B57	35782	B57	777	B71	86518910	BB51
		O3571705	B48	35782	B48	824	B75(2)	306703V1	C96
		O3576605	B42	35782	B42	956	B42	306704V1	C115
				371	C149	957	B35	360701V1	C69
				372	C51	1376	B51	360702V1	C77
				691	C60	1390	B71	360708V1	B70
				3880	BX112			360709V1	B68
				4056	B49			360710V1	C96
				11939	A62			360713V1	B83
				50600001	C78			360714V1	B117
				50600002	C78			360715V1	B199
				50600003	C78			360717V1	B46
				50600004	C85				
				50600005	C72(2)				
				50600006	C68(2)				
				50600010	C80(3)				
				50600019	C170(2)				



WARNING: These products can expose you to chemicals including carbon black which is known in the state of California to cause cancer, birth defects or other reproductive harm. For more information visit www.P65WARNINGS.ca.gov

AG EQUIPMENT & PUMP BELTING PART NUMBERS

NOTE: FHP Belt may be upgraded to the MXV Belt, however the FHP Belt SHOULD NOT be substituted for the MXV Belt

Alphabetical sequence by manufacturer

OEM #	Belt No.	OEM #	Belt No.	OEM #	Belt No.	OEM #	Belt No.	OEM #	Belt No.
VICON (GEHL)		35741	B53	312624080	A51	508938E	B84	981-0800	D120
		104617	B77	317535030	C245	515765E	C90	981-0810	C126
43301603	B92	104774	B75	317535040	C149	515766E	C80	981-08209	B58
VIKING		152351	C85	320027898	A97	515797E	C77	981-0830	C151
		174510	BB144	320082856	B108	516646E	BB112	981-0850	C86
HB7790	B75	178045	BB136	109328D	C173	518417E	B63	981-0860	C103
VOLVO/PENTA		220095	C48	10A10786	B108	521301E	B95	981-0890	C128
		247296	400J10	10A201P	BX71	523120E	B43	981-0940	B135
437791	B45	250278	C72	10A21932	B45	523121E	B55	981-0950	C144
6601032	B75	271357	B126	10A29137	C46	523725E	D101	981-1000	B84
6601197	B51	275404	C90(2)	15A10786	B108	524364E	D140	981-1010	C134
6601297	C90	302733	B49	15A10787	B146	524414E	D137	981-1180	C134
6601967	B112	303337	B96	15A12372	D85	524634E	D144	981-1190	C109
6605349	B105	303834	B98	15A13759	B51	5AL6101	B55	981-1200	C126
6605544	B51	508906	C103	15A14776	B146	5AL7221	B87	981-1250	C120
6611475	B73	516696	BB136	15A14777	B60	5CM1149	C96	981-1260	C73
6611798	B66	526155	B87(4)	15A1533	C51	673100A	A29	981-1270	C141
6612512	B60	526369	B87(3)	15A16743	C149	715A	A27	981-1290	C162
6617499	B72	526370	B87(4)	15A2764	B90	753-0080	C270	981-1350	B111
WALSH		710976	B83	15A2964	B87	753-0170	C90(2)	981-1440	C120
		716640	C111	15A3225	C72	753-0250	C144(2)	981-1450	C104
B6112	B112	719244	B210	15A3387	B112	753-0490	C185	981-1470	C202
WESTERN LAND ROLLER		760608	C100(3)	15A4046	C128	753-1040	C330	981-1480	B111
		760615	C100(2)	15A4205	B62	753-1090	C215	981-1490	B64
		910700	D170	15A5552	B66	753-2730	C90	981-1520	C138
36406	C85	1947253	B49(2)	15A6062	A70	753-2740	C113	981-1570	B62
36831	B90	1949780	A74	15A6380	B131	808S	C128	981-1670	C51(2)
1AB60	B60(4)	2713257	B128	15A646	B131	877S2	B141	981-1710	B150
1AB81	B81	2714187	B115	15A8280	B108	895411L	B210(3)	981-1730	C134
24R150	5VX710	4011317	B55	15A896	A64	897347L	B173	981-1740	B112
24R270P	BB97(3)	8958066	B142	1678R	BB128	89812L	B199	981-1760	C140
2AB55	B55(4)	8995076	B141	1680R	B53	899432L	B210	981-1770	C162
2AB71	B71(3)	9860720	CC81	1908R	B169	899469L	A71	981-1790	B218
2F34	B62	41047660	C136	303393E	C84	899519L	B218	981-1800	B152
36123B	C112	303302849	BX65(3)	30A3049	D112	899530L	B120	981-1920	C138
424R79	BB85(2)	303345092	BX65	3236D	D72	899588L	A41	993S	C149
6A11	B51	311563120	B144	36A3489	B37	981-0010	C115	A861	C66
6A12	B56	311567900	B104	3CF2701	C70	981-0020	BB153	AC10518	C140(3)
72C75P	C75	311568370	B210	3CM1098	C60	981-0030	C141	AC7656	B225
72C78	C78	311577030	B51	400114E	B43	981-0040	B100(3)	AC7744	B100
72DH187P	C136	311585750	D122	401131D	B57	981-0060	C126	AC7866	B162
72DH188P	C158	311588660	D167	401396D	C75	981-0070	B78	AC8743	C72
7AB53	B53(2)	311589740	B108	401396E	C75	981-0080	C115	AC8924	C54(3)
8007B	B78	311602420	C188	401397D	B77	981-0100	D158	AC9561	CC162
8C81	C81	311676450	C51	401397EA	B76	981-0120	B62	AC9865	B68(4)
FG887P	A42(2)	311680230	B230	401398D	C69	981-0130	A167	AP2859	B87
GM144P	B75	311680730	B240	402122D	B42	981-0140	A176	AP3282	B79
GM597P	A46(2)	311682670	A76	402939D	D136	981-0160	B95	AP3420	B66
GM81	B38	311683780	C46	403404D	C164	981-0170	C66	BPS23	B136
H405	C240	311690220	D166	403407D	C195	981-0180	B97	BXR3007	B53
PT011	B85	311730590	B126	403408D	C117	981-0200	B195	BXS11(A)	B46
PT012	B75(8)	311730870	D169	403409D	C68	981-0230	B62	BXS20	B53
SA10	B108	311764410	A76	403410D	B144	981-0309	B65	BXS21	B51
SA89	A75	311781280	C206	403723D	C115	981-0310	B65	BXS23	B136
WESTFIELD		312414670	A48	404197D	BB144	981-03109	B64	BXS26	B153
		312439700	C167	405453D	B141	981-0320	B53	BXS29	C162
9187	B90	312439730	B67	405705D	A100	981-03209	B53	CO10044	C89
9188	B95	312448930	A80	4059K	B75	981-0322	B53	CO10045	B47
		312449290	A87(2)	4060K	B51	981-0330	B109	CO10053	B108
WESTMORE PULVERIZER		312449310	MXV5-560	4061K	C120	981-03309	B109	CO10116	C79
		312456600	C72	408131D	B42	981-03409	B116	CO10473	B210
7010	B40	312492070	B66	408137D	B146	981-0440	C118	CO10518	C139(2)
7237	B42	312503850	C162	408289D	B87	981-060	B95	CO10682	C63
7250	B38	312534870	B59	408291D	B164	981-06107	B133	CO11085	B173
8002	B225	312538690	B195	408292D	B180	981-0640	B168	CO11011	C66
8101	B173	312538930	A71	408322D	B180	981-0650	B164	CO11153	B131
8102	B158	312538940	A67	408982D	BB136	981-0660	B133	CO11322	B105
8201	B144	312541610	A74	409183D	B51	981-0680	D162	CO11386	C60
8202	B133	312543650	C120	409198D	B51	981-0700	D169	CO11397A	A37
8300	B53	312543960	B69	409198D	B51	981-07109	B162	CO11530	B97
8301	B136	312543970	B59	409328D	C173	981-0720	CC81	CO11671	B117
8401	B75	312546230	C97	45479A	CX68	981-07209	B136	CO11768	B158
11714	B66	312547870	C158	4780K	C51	981-07309	B99	CO3879	B85
WHITE FARM EQUIPMENT		312549250	B53	4855C	B85	981-0740	C113	CO4305A	B38
		312553480	C74(4)	4863A	C58	981-0750	B79	CO4943	B114
		312571540	A75	4885C	B85	981-0770	B71	CO7272	C89
		312604010	B71(2)	503966E(A)	BB128	981-07709	B71	CO7656	B225
335	B122(4)	312612530	A130	508164E	BB94	981-0780	B99	CO7676	B116
4863	C58	312614790	B91	508366E	B77	981-0790	B104	CO7706	B35



WARNING: These products can expose you to chemicals including carbon black which is known in the state of California to cause cancer, birth defects or other reproductive harm. For more information visit www.P65WARNINGS.ca.gov

CROSS-REFERENCE - AG EQUIPMENT

AG EQUIPMENT & PUMP BELTING PART NUMBERS

NOTE: FHP Belt may be upgraded to the MXV Belt, however the FHP Belt SHOULD NOT be substituted for the MXV Belt

Alphabetical sequence by manufacturer

OEM #	Belt No.	OEM #	Belt No.	OEM #	Belt No.	OEM #	Belt No.	
WHITE FARM EQUIPMENT		MXO115	B65	XAD239	C144	23946	B273	
CO7744	C99	MXR3004	B162	XAD248	C75	24004	B132	
CO7744A	C101	MXR3005	C144	XAD336	B169	24102	C220	
CO7791	B114	MXS1495	B32	XAD351	B83	26840	B124	
CO7866	B161	MXS1668	B47	XAD381	B86(2)	27652	B139	
CO8017A	B120	MXS1789	B109	XAD386	C195	27875	B205	
CO8095	B125	MXS216	B133	XAD747	CC112	28167	B240	
CO8504	C62	MXS228	B32	XAD748	C51	28975	B103	
CO8545	B133	PA2298	C51	XAD749	C158	29229	B130	
CO8660A	B95	PB147	B142	XAD750	B120	31615	MXV5-1180	
CO8743	C70	PK1191BV	A55	XAD751	B144	31666	C218	
CO8744	C51	PK1570BV	A48	XAD753	B195	31748	B126	
CO8904	C106	PO3008	B47	XAD754	B218	32650	B205	
CO8905	B51	PO3068	B48	XAD771	B87	32906	B198	
CO8916	B218	PO3230	C69	XAD772	B173	33050	B255	
CO8985	B199	PO3282	B79	XAD919	A46	33652	B150	
CO9036	B38	R1003	C69	XAD920	B78	33710	B173	
C9060A	B46	RH2288	B79	XAD921	B167	35543	B225	
CO9146A	D128	S1228	B64	XAF227	B117	41826	CC128	
CO9147	C72	S1229	B133	Y7166	B87	65217	B85	
CO9296	B81	S1230	B48	Y7189	B75	65217	MXV5-880	
CO9561	CC158	S1260	B87	Y7200	B71(3)	65218	B70	
CO9887	C81	S1309B	B128	Y7219	B75	65218	MXV5-730	
CO9917	B48	S257	B38	Y7247	B71	65611	B124	
CXS42	B93	S627	C60	Z459	C51	70341	AX34(2)	
CXS72(A)	B106	S806	B185	Z671	3V530	72346	C130	
EXS18	B108	S807	B53	Z861	C66	72821	MXV5-430	
EXS19	B114	S944	B71	WILLMAR			161711	B193
EXS28	B100	SO579B	B55	B70	B70	10419C	B38	
EXS29	B105	SO800B	B77	W-4M1052	BB112	10429C	B60	
EXS41	B210	SO819B	B79	WIL-RICH			10449C	B124
FH1213	B199	SXO61	BB210	17630	A81(2)	2474A	BB144	
FHY291	D140(2)	SXO68	B122	18588	A75(2)	26840A	B124	
HXR3004	B162	SXO69	BB97	19263	A93(2)	32970A	B204	
HXR3005	B180	SXR3000	B85	70225	B56(4)	B48	B48	
HXR3012	B161	SXS71	B109	A7630	A81(2)	RM230	C225	
HXR3014	BB155	TXO35	B82	WOODS & COPELAND			RM49	B148
HXS109	C88	TXO40	BB120	62090	B61	W137	B162	
HXS81	C93	TXS54	C62	62165	B71	W180	B210	
HXS82	C90	UXO6	B158	WOODS DIVISION/ HESSTON			71460001	AX50
HXS90	C85	UXR3034	B98	1469	B133	71460002	EX52	
J106V	C162	UXR3053	B75	1469	MXV5-1360	71460003	BX77	
J235V	C207	UXR3054	B58	1532	C136	71460010	BX50	
J383V	C195	UXS13	B116	2400	B128	71460011	BX71	
J402V	C188	VX551	B38	2400	MXV5-1310	71460012	BX58	
JX04	B93	VXR3083	B63	3492	B204	71460013	BX85	
JX05	B87	VXS649	C180	4927	B133	71460023	AX48	
JX06	B166	WXS321	B42	4927	MXV5-1360	71460024	AX51	
JXR3000	B240	WXS328	B98	5711	B240	71460034	MXV4-500	
JXS7	B151	WXS375	B47	6857	C152	WYATT		
JXS8	B142	WXS8(A)	B83	10676	B158	10419C	B38	
JXS9	B154	WXS95	B87	10859	B248	10429C	B60	
K137121	B218	XAD1049	C144	10864	B173	10449C	B124	
K146611	B120	XAD1073	B120	11466	B255	B48	B48(2)	
K231	C55	XAD1081	B83	15415	B144	YANMAR		
K265	C48	XAD1105	B147	18186	B195	785539	A100	
LT6063	C54	XAD1191	B148	18440	B221	YEAR - AROUND CAB		
M1324	A51	XAD1199	BB68	23894	B180	61008376	C112	
M2684BV	A96	XAD1256	C75	23943	B270	61008377	C124	
MBX9504	A78	XAD1257	CC112	23944	B162			
MEX9504	A78	XAD1298	BB180(2)					
MO2305	C73	XAD1314	C51					
MXO114	B62	XAD1316	B133					
		XAD1317	B158					
		XAD235	B38					

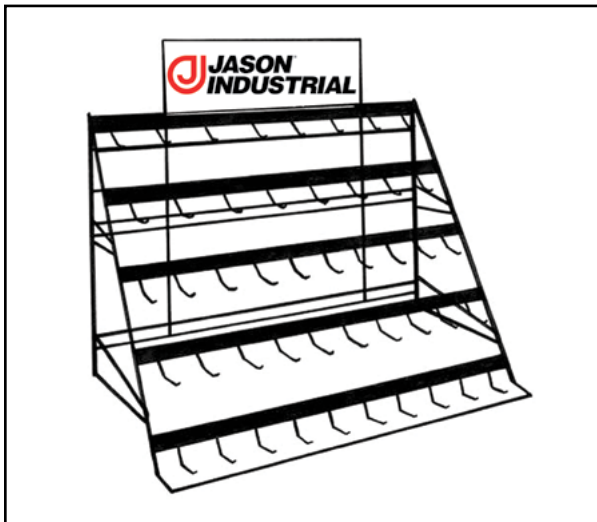

V-Belt Display

Display has 49 hooks. Display height is 16-5/8", width 48", 26-1/4" front-to-back.

PART NUMBERS:

Rack: WFD-49

Side Panel: SP-49

Sign Holder: SH-49

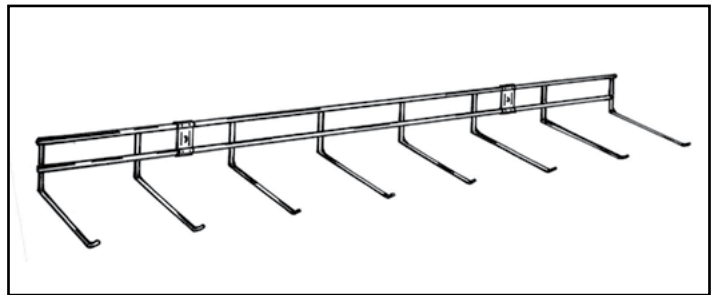

V-Belt Wall Rack

36" long mounting rack with eight 8" hooks provided.

Includes two brackets for quick, easy, durable mounting.

PART NUMBER: WHD-7

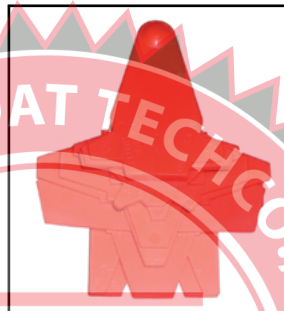

Sheave Gauge

Can be used to determine both Sheave and Belt size. Check for sheave wear to determine when a replacement is necessary.

PART NUMBER: G001



110" Belt Measurer

Measures all size industrial belts up to 110" in ranges of 3/8", 1/2" and 5/8" accurately and efficiently.

PART NUMBER: 32-9108



Tension Tester Gauge

Assures proper belt tension and installation.

PART NUMBER: TESTER

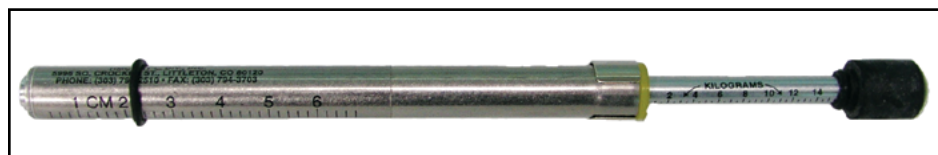

WARNING: These products can expose you to chemicals including lead which is known in the state of California to cause cancer, birth defects or other reproductive harm. For more information visit www.P65WARNINGS.ca.gov

TERMS, CONDITIONS AND LIMITED WARRANTY OF SALE

All prices, terms and conditions of sale are subject to change without prior notice. Buyer agrees to all terms and conditions of seller upon the placement of any and all purchase orders.

GENERAL

- All orders are subject to a minimum charge of \$25.00.
- All claims must be made within seven (7) days of receipt of merchandise.
- The company reserves the right at all times to reject any and all orders for any reason.

PAYMENT TERMS

- Net 30 days (to approved and qualified accounts).
- We reserve the right to hold shipments against past due accounts.
- Seller may require full or partial payment in advance if, in its sole judgement, the financial condition of the buyer does not justify the terms specified.
- All past due accounts are subject to a late payment charge of 1.5% per month, or maximum allowed by law if different, along with the expenses incidental to collection including reasonable attorney's fees.
- Returned checks are subject to a minimum \$50.00 charge.

FREIGHT TERMS

- Collect
- Orders with different numbers and dates may not be combined to make freight allowance.
- Prepaid orders requiring immediate delivery that must be shipped from different Jason locations may be subject to a freight surcharge. Such determination will be made at the time of order.
- Backorders will be shipped in the most practical fashion with charges consistent with our freight policy established with the original order.

ACCEPTANCE, ALTERATION AND CANCELLATION OF ORDERS

Orders for other than standard items or standard lengths may not be cancelled after purchase has been committed, production scheduled or any costs incurred.

RETURN OF DEFECTIVE MERCHANDISE

Defective or failed material to be held at the buyer's premises until authorization has been granted by seller to return or dispose of merchandise. Merchandise to be returned for final inspection must be returned Freight Prepaid in the most economical way. Credit will be issued for material found to be defective upon our inspection based on prices at time of purchase.

MERCHANDISE SHIPPED IN ERROR

Buyer must notify seller immediately on any merchandise shipped in error. Upon notification, merchandise is to be returned to seller either via truck on a Freight Collect basis, via carrier of our choice, or via UPS on a Freight Prepaid basis. Buyer will be reimbursed for cost of merchandise, plus any additional freight which may have been incurred due to shipping error.

MERCHANDISE ORDERED IN ERROR

Standard packaged merchandise only may be returned, provided that the merchandise is in the original buyer's possession not more than 30 days. If merchandise is accepted for return, merchandise must be returned Freight Prepaid, and buyer will be charged a minimum of 15% rehandling charge, plus a chargeback for outbound freight charges if the original order was shipped prepaid. Returns are not accepted for any merchandise that is specifically manufactured to meet the buyer's requirement of either specifications or large quantity.

DELIVERY, DAMAGES, SHORTAGES

Delivery to the initial common carrier shall constitute the delivery to the buyer. Our responsibility, insofar as transportation risks are concerned, ceases upon the delivery of the merchandise in good condition to such a carrier, and all the merchandise shall be shipped at the buyer's risk.

GOODS DAMAGED IN SHIPMENT

Upon receipt of shipment, any evidence of damage to original shipping package must be reported by the receiving party and a claim made with the delivering carrier upon receipt of shipment.

CONCEALED DAMAGE

Any evidence of damage to material shipped, upon the opening of the original shipping package, must be reported by the receiving party to and a claim made with the delivering carrier without delay.



LIMITED WARRANTY

The merchandise or products sold or distributed by Megadyne Americas LLC are warranted to our customers to be free from defects in material and workmanship at the time of shipment by us. All warranty claims shall be made within 90 days after we have shipped the merchandise. Our liability hereunder is limited to the purchase price of any merchandise proved defective, or, at our option, to the replacement of such merchandise upon its authorized return to us.

THIS WARRANTY IS IN LIEU OF AND EXCLUDES ALL OTHER WARRANTIES, EXPRESSED, IMPLIED, STATUTORY, OR OTHERWISE CREATED UNDER APPLICABLE LAW INCLUDING, BUT NOT LIMITED TO, THE WARRANTY OF MERCHANT ABILITY AND THE WARRANTY OF FITNESS FOR A PARTICULAR PURPOSE. IN NO EVENT SHALL WE BE LIABLE FOR SPECIAL, INCIDENTAL, OR CONSEQUENTIAL DAMAGES, INCLUDING LOSS OF PROFITS.

Copyright Notice: Megadyne America LLC copyright. All rights reserved. Megadyne is and shall remain the owner of all right on drawings, technical specifications and any other information contained in the present catalog or otherwise communicated by Megadyne America LLC to the customer. The customer shall not disclose such information to third parties or use such information for purposes different from the definition of the order to Megadyne America LLC, unless upon prior written authorization of Megadyne.



DUC THANG DAT TECH CO., LTD

Customer Service
800.527.1247

POWER TRANSMISSION

The central graphic is a circular logo with a serrated, gear-like border. It contains the company name 'DUC THANG DAT TECH CO., LTD' at the top, 'Customer Service' and the phone number '800.527.1247' in the center, and 'POWER TRANSMISSION' at the bottom. There are five small stars below the phone number.



BELARUS**Minsk**

Phone +375 17 2802486
Info.by@megadynegroup.com

BRAZIL**Sorocaba**

Phone +55 15 2101 7700
Info.br@megadynegroup.com

CANADA**Edmonton**

Phone: +1 780 461 4400
Info.ca@megadynegroup.com

Montreal

Phone: +1 514 31 2341
Info.ca@megadynegroup.com

Toronto

Phone: +1 905 602 4400
Info.ca@megadynegroup.com

CHINA**Beijing**

Phone +86 10 8150 7478
info.cn@megadynegroup.com

Foshan

Phone +86 757 83815530
info.cn@megadynegroup.com

Fujian

Phone +86 595 8816 0309
info.cn@megadynegroup.com

Ningbo*

Phone +86 574 8650 2886
info.cn@megadynegroup.com

Qingdao*

Phone +86 532 8765 2117
info.cn@megadynegroup.com

Shanghai

Phone +86 21 5447 1473
info.cn@megadynegroup.com

Shenyang

Phone +86 24 2572 3238
info.cn@megadynegroup.com

COLOMBIA**Bogotá**

Phone: 011 57 669 3604.
Info.co@megadynegroup.com

Cartagena

Phone: 011 57 313 501 5397
Info.co@megadynegroup.com

CZECH REPUBLIC**Prague**

Phone +420 2 8481 7181
Info.cz@megadynegroup.com

FRANCE**Paris**

Phone +33 1 6079 8200
info.fr@megadynegroup.com

St. Jean De Maurienne*

Phone +33 4 7964 0613
info.fr@megadynegroup.com

GERMANY**Borchen**

Phone +49 5251 8735 0
info.de@megadynegroup.com

Elchingen*

Phone +49 7308 9665 0
info.de@megadynegroup.com

HUNGARY**Budapest**

Phone +36 23 428 628
info.hu@megadynegroup.com

INDIA**Chennai***

Phone +91 98841 81175
info.in@megadynegroup.com

ITALY**Turin***

Phone +39 011 926 8052
info@megadynegroup.com

Milan*

Phone +39 039 689 601
info.it@megadynegroup.com

Pescara

Phone +39 085 9700547
info.it@megadynegroup.com

Venice

Phone: +39 041 929 367
info.it@megadynegroup.com

MEXICO**Mexico C.P.**

Phone +52 55 5587 3680
info.mx@megadynegroup.com

PERU**Lima**

Phone +51 995 866 561
info.pe@megadynegroup.com

POLAND**Bydgoszcz***

Phone +48 52 348 77 12
info.pl@megadynegroup.com

SOUTH AFRICA**Johannesburg**

Phone +27 (0)12 661 1652
info.za@megadynegroup.com

Cape Town

Phone +27 (0)21 9820772
info.za@megadynegroup.com

SPAIN**Barcelona***

Phone + 34 933 774 441
www.avetm.com

Vilanova*

Phone +34 93 811 5450
info.es@megadynegroup.com

SWEDEN**Kristianstad**

Phone +46 101309600
info.se@megadynegroup.com

THAILAND**Bangkok**

Phone: +66 (0) 27115477
info.th@megadynegroup.com

TURKEY**Izmir***

Phone +90 232 877 07 00
info.tr@megadynegroup.com

U.K.**Birmingham**

Phone: +44 1384 215 021
info.uk@megadynegroup.com

U.S.A**California**

Phone +1 323 265 8061
info.us@megadynegroup.com

Florida

Phone +1 813 241 4111
info.us@megadynegroup.com

Georgia*

Phone +1 770 887 9725
info.us@megadynegroup.com

Illinois

Phone: +1630 752 0600
info.us@megadynegroup.com

New Jersey - Americas HQ

Phone +1 973 227 4904
info.us@megadynegroup.com

New York*

Phone +1 716 667-7450
info.us@megadynegroup.com

North Carolina*

Phone +1 704 583 5388
info.us@megadynegroup.com

Oregon

Phone +1 503 231 7224
info.us@megadynegroup.com

Texas

Phone +1 972 438 6992
info.us@megadynegroup.com

HEADQUARTERS**ITALY Turin**

Via S. Lucia, 114
10075 Mathi (Torino)
Phone +39 011 926 8052
info@megadynegroup.com

www.megadynegroup.com
www.jasonindustrial.com

*Manufacturing Location

